

abert

RIPARTIRE IN SICUREZZA IDEE PER LA RISTORAZIONE

Consigli e idee utili per ripartire in sicurezza e con professionalità.

INDICE

LA FILOSOFIA DELLA NUOVA RISTORAZIONE	.3
IL CARRELLO IN CAMERA	.4
IL VASSOIO IN CAMERA	.5
IL BUFFET IN SALA COLAZIONI	.9
IL SERVIZIO AL TAVOLO CON CLOCHE	.10
L'OSPITALITÀ E LA SICUREZZA DEL CLIENTE AL RISTORANTE	.11
I CARRELLI AL RISTORANTE	.13
LA PASTICCERIA AL BAR/RISTORANTE	.19

E' importante che ogni locale si interroghi sul tipo di servizio che può realmente offrire, anche in base alle attrezzature di cottura di cui dispone. Le attrezzature giocano un ruolo fondamentale nella gestione del nuovo modo di fare ristorazione.

Il cliente non si muove, il servizio "a domicilio" (in camera).



V420451001
Gueridon Lux
senza cassetto
rovere chiaro
90x50x80h cm



V420451002
Gueridon Lux
senza cassetto
rovere scuro
90x50x80h cm



V420451003
Carrello Lux
con cassetto
rovere chiaro
90x50x80h cm



V420451004
Carrello Lux
con cassetto
rovere scuro
90x50x80h cm



Non semplici vassoi ma soluzioni ad hoc per permettere un servizio impeccabile, facile e sicuro.

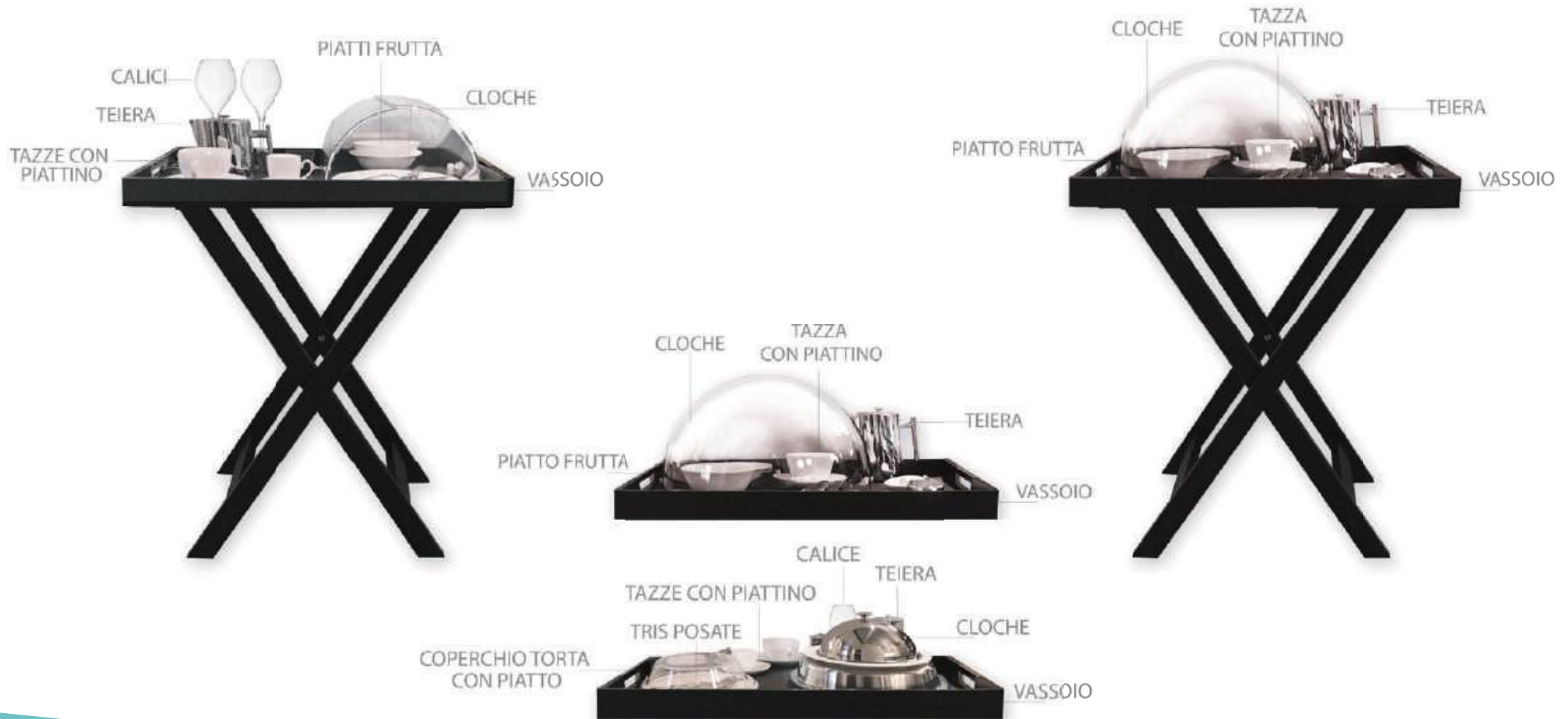



V771215T33
Cloche Ø26 cm in
policarbonato



V761215T01
Coperchio tondo a bascula
in metacrilicato Ø34 cm



V771215G11
Coperchio rettangolare a
bascula in metacrilicato
47x27 sp.3 cm



V771215T46
Coperchio tondo a bascula
in metacrilicato Ø41 cm



V760554R01
Portaformaggi-affettati
rettangolare refrigerato
Square 50x30x20h cm



V760554T01
Portaformaggi-affettati
tondo refrigerato Square
38x38x23h cm



NEW

V420423001
Vassoio in legno Lux
60x39,5x4,5h cm



NEW

V420423002
Pliant pieghevole
in legno Lux
70h cm

V010523R45

Vassoio rettangolare con
bordo 45x36 cm A.Inox

V010523R52

Vassoio rettangolare con
bordo 50x40 cm A.Inox

V010523R62

Vassoio rettangolare con
bordo 62x48 cm A.Inox

V010523R65

Vassoio rettangolare
65x45 cm A.Inox

NEW

V010523G21M

Vassoio rettangolare GN con
maniglia 65x53 cm A.Inox

V010523G11

Vassoio rettangolare GN11
53x32,5 cm A.Inox

V010523G21

Vassoio rettangolare GN21
65x53 cm A.Inox



Per aumentare la sicurezza delle protezioni standard.



NEW

V771281001

Barriera igienica per buffet in plexiglass
chiusa nella parte frontale e superiore
telaio in alluminio
73x34x51h cm

V771281002

Barriera igienica per buffet in plexiglass
chiusa nella parte superiore
con telaio in alluminio
73x34x51h cm

Il passato che ritorna in guanti bianchi e ci riporta a ricordi di antica memoria sinonimo di eleganza senza tempo ed oggi anche di sicurezza.



V010553024 Cloche Ø24 cm A.Inox

V010553026 Cloche Ø26 cm A.Inox

V010553028 Cloche Ø28 cm A.Inox

V010553030 Cloche Ø30 cm A.Inox



3050553619 Copripiatto sovrapp. Ø24,7cm A.Inox
(adatta per piatti 24,5-24)

3050553620 Copripiatto sovrapp. Ø27,1cm A.Inox
(adatta per piatti 27-26)

3050553621 Copripiatto sovrapp. Ø28,2cm A.Inox
(adatta per piatti 28-27,5)

3050553604 Copripiatto sovrapp. Ø29,2cm A.Inox
(adatta per piatti 29-28,5)

3050553622 Copripiatto sovrapp. Ø29,8cm A.Inox
(adatta per piatti 29,5-29)

L'OSPITALITÀ E LA SICUREZZA DEL CLIENTE AL RISTORANTE

Contenitori Easy Fresh ideali per riporre i D.P.I. individuali.



AVARITCO A03

Contenitore ermetico rettangolare
1lt 22,4x15,2x5,2h cm

AVARITCO A04

Contenitore ermetico rettangolare
1,5lt 22,4x15,2x7,2h cm

L'OSPITALITÀ E LA SICUREZZA DEL CLIENTE AL RISTORANTE

La posateria acquista maggior sicurezza appoggiata su un portaposate.



V010581005
Poggiaposate/
Poggiabastoncini
6x3,5 cm



9030584662
Poggiaposate/
Poggiabastoncini
5,6 cm



9030584670
Poggiaposate/
Poggiabastoncini
Ø10 cm



1181200081 Trasparente
1181200082 Nero
Poggiaposate/
Poggiabastoncini ABS
5x2,8x1,2 cm



1180500081
Poggiaposate/
Poggiabastoncini
7,4x3 cm

I CARRELLI AL RISTORANTE

Per potersi sentire più al sicuro e rilassato, il cliente cercherà di stare nello stesso posto per più tempo, il ristorante sarà quindi il posto perfetto per l'aperitivo.



Carrello cocktail
90x50 h.90,5 cm

V420451011 Rovere chiaro



V420451012 Rovere scuro





Carrello dolci/formaggi refrigerato
90x50x108h cm

V420451013 Rovere chiaro



V420451014 Rovere scuro



Carrello arrosti
90x50x90h cm

V420451009 Rovere chiaro



V420451010 Rovere scuro





Carrello Lux bar/liquori
50x90x112h cm

V420451015 Rovere chiaro



V420451016 Rovere scuro



Top dolci/formaggi refrigerato
90x50x28h cm

V420451T05 Rovere chiaro



V420451T06 Rovere scuro



Top bar/liquori
90x50x10,5h cm

V420451T03 Rovere chiaro



V420451T04 Rovere scuro



Integrando tecnologia UV-C con le norme igieniche previste si sanifica l'ambiente chiuso di un carrello "a vista" per portare in tavola mis en place e alimenti.



NEW

V420451019

Carrello ad ambiente sanificato
rovere scuro
90x50x80h cm

V420451T07

Top ad ambiente sanificato
rovere scuro
90x50x28h cm

INFORMAZIONI SUL CARRELLO SANIFICATO:

Il carrello sanificato agisce tramite la sanificazione dell'aria in esso contenuta.

In 20 minuti la luce UV-C **sanifica il 99% dell'aria** che, tramite una ventola, viene forzata a passare sotto la luce.

La mise en place verrà preparata di fronte al cliente al tavolo.

Se si chiude l'apposita bocchetta in plastica prevista alla base della Cloche, si può usare il carrello in due modi diversi:

- La parte inferiore per portare piatti, posate, bicchieri, tovaglia e tovagliolo
- La parte superiore (Top) per portare il cibo protetto dalla cloche.

Un sistema perfetto per accontentare lo chef, il vostro cliente e le normative vigenti.



V430451001

Carrello Basic rovere chiaro
80x50 h.80 cm

V430451003

Carrello Basic rovere chiaro
70x35 h.80 cm

NEW



V430451002

Carrello Basic rovere scuro
80x50 h.80 cm

V430451004

Carrello Basic rovere scuro
70x35 h.80 cm

NEW



V77125201P
Pastry Rectangular Large Tray
V77125203P
Pastry Small Tray



V77125202P
2-tier Pastry Tray



V7712520TP
Pastry Round Tray Ø46 cm
V7712520TP1
Round ABS croissant tray
Ø38 cm



V77125401P
Thermal food tray ABS
rectangular



V77125402P
Thermal food tray ABS
rectangular double



V60129401147
Portaformaggio
ø30 tortora PP Color Style
V60129401113
Portaformaggio
ø30 bianco PP Color Style



V60129401047
Portatorta ø30 tortora PP
c/man.e base p/eutetr.
V60129401013
Portatorta ø30 bianco PP
c/man.e base p/eut.



V771295P02
Set pz.2 eutettici rettangolari piccoli
per refrigerare il portatorta/portaformaggio



abert

ABERT S.p.A.
Via Don P. Mazzolari, 17
25050 Passirano (BS) Italy
T. +39 030 6853601-602
F. +39 030 6853610
www.abert.it

LUX



abert®

abert[®]

Combina i diversi elementi per personalizzare il tuo carrello.

Design lineare ed eleganza dal sapore naturale sono i tratti distintivi di questa linea: una proposta di carrelli da comporre a piacimento, mixando gli elementi standard per un servizio unico e su misura.

Combine the different elements to customise your trolley.

Linear design and natural elegance are the distinguishing features of this line: a range of trolleys that you can compose as you wish, by mixing the standard elements for a bespoke and unique service.



Carrello Gueridon

Gueridon trolley

	Cm	Colore / Color
 V42 04 51 001	90x50 h.80	Rovere chiaro / Light oak
 V42 04 51 002	90x50 h.80	Rovere scuro / Dark oak

**Carrello Servire con due cassetti**

Service trolley, 2-drawer

	Cm	Colore / Color
 V42 04 51 003	90x50 h.80	Rovere chiaro / Light oak
 V42 04 51 004	90x50 h.80	Rovere scuro / Dark oak





Top dolci / formaggi refrigerato

Dessert/cheese top, refrigerated

	Cm	Colore / Color
 V42 04 51 T05	90x50 h.28	Rovere chiaro / Light oak
 V42 04 51 T06	90x50 h.28	Rovere scuro / Dark oak

Carrello Gueridon

Gueridon trolley

	Cm	Colore / Color
 V42 04 51 001	90x50 h.80	Rovere chiaro / Light oak
 V42 04 51 002	90x50 h.80	Rovere scuro / Dark oak

**Top bar con ringhiera 90x50**

Bar top with railing

	Cm	Colore / Color
 V42 04 51 T03	90x50 h.10,5	Rovere chiaro / Light oak
 V42 04 51 T04	90x50 h.10,5	Rovere scuro / Dark oak

**Carrello Servire con due cassetti**

Service trolley, 2-drawer

	Cm	Colore / Color
 V42 04 51 003	90x50 h.80	Rovere chiaro / Light oak
 V42 04 51 004	90x50 h.80	Rovere scuro / Dark oak

Carrello bar / liquori

Bar/liquor trolley

	Cm	Colore / Color
V42 04 51 015	90x50 h.90,5	Rovere chiaro / Light oak
V42 04 51 016	90x50 h.90,5	Rovere scuro / Dark oak

**Carrello dolci / formaggi refrigerato**

Dessert/cheese trolley, refrigerated

	Cm	Colore / Color
V42 04 51 013	90x50 h.108	Rovere chiaro / Light oak
V42 04 51 014	90x50 h.108	Rovere scuro / Dark oak



Accessori per foro

Hole accessories

Contenitore in acciaio per GN

Steel container for GN

V42 05 51 006 43x40 h. 16 Cm

Compatibile con

Compatible with

1 x GN 2/3V01 05 72 G23D h. 15 Cm
V01 05 15 G23 coperchio / lid**1 x GN 1/3**V01 05 72 G13D h. 15 Cm
V01 05 15 G13 coperchio / lid**Scaldavivande GN 2/3**

GN 2/3 chafing dish

305 05 52 695 Coperchio in acciaio / St. Steel lid
305 05 52 694 Coperchio in vetro / Glass lid**Piastra induzione + piano lavoro acciaio**

Induction plate + steel countertop

V42 05 51 002 84x40,5 h.7 Cm

Accessori ad incastro sulle ringhiere

Interlocking accessories on railings

Porta bottiglie / glacette

Bottle/bottle-cooler holder

V420551003 46x17 h.1,6 Cm

Compatibile con

Compatible with

3 x Glacette

Bottle coolers

V78 05 24 01 01 401 Ø12 h.17 Cm

Porta sorbetti

Sherbet-pot holder

V42 05 51 004 46x17 h.1,6 Cm

Compatibile con

Compatible with

2 x Sorbetti

Ice bucket

V78 05 20 00 11 401 Ø15 h.19,5 Cm

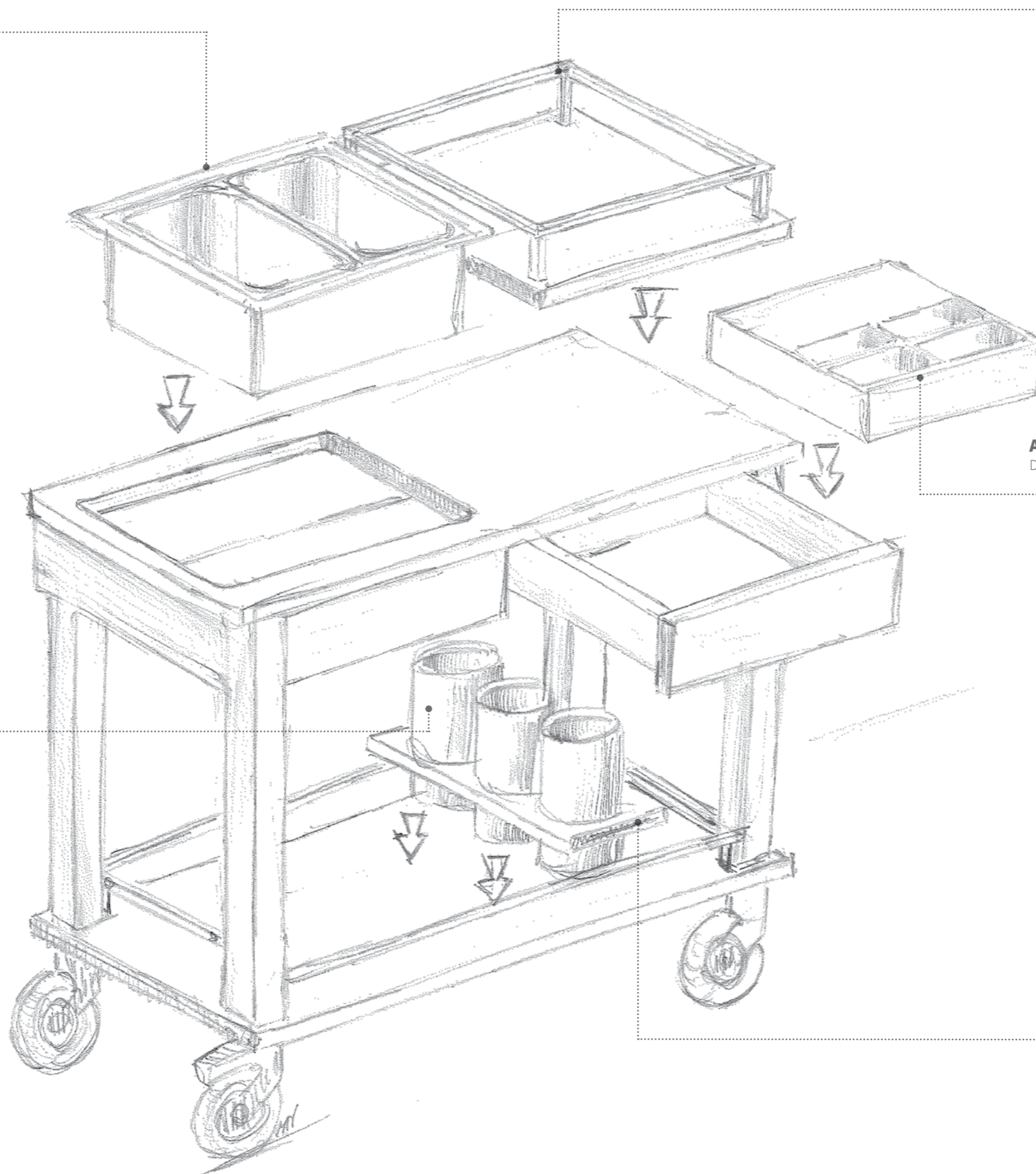
**Top bar con ringhiera 41x50**

Bar top with railing 41x50

V42 04 51 T01 41x50 h.10,5 Cm

V42 04 51 T02 41x50 h.10,5 Cm

Tagliere in legno

Wood cutting board

V42 04 71 001 38x40 h.2 Cm

Accessori per cassetto

Drawer accessories

Inserto portaposate

Cutlery-holder insert

V42 04 94 001 36x29 h.7 Cm

Inserto portacondimenti

Condiment-holder insert

V42 05 51 005 36x29 h.7 Cm

Compenso poggiapiatti

Dish tray

V42 04 42 001 29,5x25 h. 7 Cm

Ringhiera porta accessori

Accessory-holder railing

V42 05 51 001 46x86 h.8 Cm



Carrello cocktail

Cocktail trolley

	Cm	Colore / Color
 V42 04 51 011	90x50 h.90,5	Rovere chiaro / Light oak
 V42 04 51 012	90x50 h.90,5	Rovere scuro / Dark oak

**Carrello arrosti**

Roast-beef trolley

	Cm	Colore / Color
 V42 04 51 009	90x50 h.90	Rovere chiaro / Light oak
 V42 04 51 010	90x50 h.90	Rovere scuro / Dark oak



Carrello Flambé ad induzione

Flambé trolley - induction

	Cm	Colore / Color
 V42 04 51 007	90x50 h.80	Rovere chiaro / Light oak
 V42 04 51 008	90x50 h.80	Rovere scuro / Dark oak

**Carrello multiuso**

Universal trolley

	Cm	Colore / Color
 V42 04 51 005	90x50 h.80	Rovere chiaro / Light oak
 V42 04 51 006	90x50 h.80	Rovere scuro / Dark oak



Top bar con ringhiera 90x50

Bar top with railing 41X50

	Cm	Colore / Color
V42 04 51 T03	90x50 h.10,5	Rovere chiaro / Light oak
V42 04 51 T04	90x50 h.10,5	Rovere scuro / Dark oak

**Top dolci / formaggi refrigerato**

Dessert/cheese top, refrigerated

	Cm	Colore / Color
V42 04 51 T05	90x50 h.28	Rovere chiaro / Light oak
V42 04 51 T06	90x50 h.28	Rovere scuro / Dark oak

**Ringhiera porta accessori**

Accessory-holder railing

Inox 18/10 - St. Steel

	Cm
V42 05 51 001	46x86 h.8

**Piastra induzione + piano lavoro acciaio**

Induction plate + steel countertop

	Cm
V42 05 51 002	84x40,5 h.7

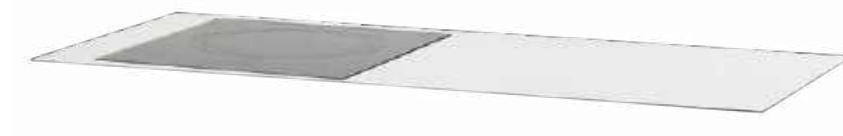
**Vasca ghiaccio / secchio champagne**

Ice pan / champagne bucket

Inox 18/10 - St. Steel

Contenitore in acciaio per GN	V42 05 51 006	43x40 h. 16
Steel container for GN		

**Compatibile con**

Compatible with

1 x GN 2/3	V01 05 72 G23D V01 05 15 G23	h. 15 Cm coperchio / lid
1 x GN 1/3	V01 05 72 G13D V01 05 15 G13	h. 15 Cm coperchio / lid

**Top bar con ringhiera 41x50**

Bar top with railing 41X50

	Cm	Colore / Color
V42 04 51 T01	41x50 h.10,5	Rovere chiaro / Light oak
V42 04 51 T02	41x50 h.10,5	Rovere scuro / Dark oak



Scaldavivande GN 2/3

GN 2/3 chafing dish

	Cm	H cm	
305 05 52 695	43 x 40	21	Con coperchio in acciaio / St. Steel lid
305 05 52 694	43 x 40	21	Con coperchio in vetro / Glass lid

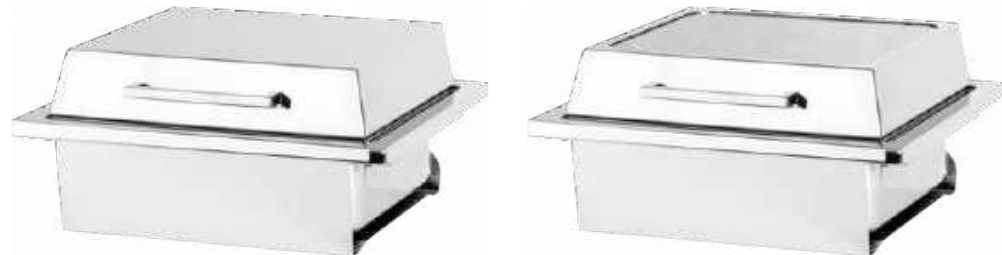
**Fornelletto per scaldavivande**

Chafing-dish burner

V77 05 52 FDC	Fornelletto / Burner (incluso / included)
B25 05 52 675	Supporto / Support (incluso / included)

**Piastra elettrica per scaldavivande**

Heating element for chafing-dishes

non incluso / not included

	V	W	Hz
V77 05 52 PCT	220	500	50
V77 05 52 PCT1	230	250	

Con regolatore / With power regulator

**Tagliere in legno**

Wood cutting board

	Cm
V42 04 71 001	38x40 h.2

**Porta bottiglie / glacette**

Bottle/bottle-cooler holder

Inox 18/10 - St. Steel

	Cm
V42 05 51 003	46x17 h.1,6

**Compatibile con**

Compatible with

3 x Glacette
Bottle coolers

V78 05 24 01 01 401

Ø12 h.17 Cm

**Porta sorbettiere**

Sherbet-pot holder

Inox 18/10 - St. Steel

	Cm
V42 05 51 004	46x17 h.1,6

**Compatibile con**

Compatible with

2 x Sorbettiere
Ice bucket

V78 05 20 00 11 401

Ø15 h.19,5 Cm



Inserto portaposate

Cutlery-holder insert

Legno multistrato - Multilayer wood

V42 04 94 001 Cm
36x29 h.7



Cassetto estraibile con chiusura ammortizzata

Pull-out drawer with silent closing



Inserto portacondimenti

Condiment-holder insert

Inox 18/10 / 18/10 st. steel - ABS

V42 05 51 005 Cm
36x29 h.7



Gamba in legno massello e piani rivestiti in laminato

Solid wood stand and tops, covered in laminate



Compenso poggia piatti

Dish tray

Legno multistrato - Multilayer wood

V42 04 42 001 Cm
29,5x25 h. 7



Ruota pivotante antistatica con freno ø13Cm

Anti static pivoting wheel with brake, ø13Cm



Carrello Basic

Basic trolley

	Cm	Colore / Color
■ V43 04 51 002	80x50 h.80	Rovere scuro / Dark oak

**Caratteristiche tecniche:**

- Gamba in acciaio inox 18/10
- Ruota pivotante ø13 Cm
- Piani rivestiti in laminato
- Ruote pivotanti, di cui due con freno

Technical characteristics:

- *Stainless steel stand*
- *Pivoting wheel, ø13 Cm*
- *Laminate covered tops*
- *Pivoting wheels, two with brakes*

Carrello Basic

Basic trolley

	Cm	Colore / Color
■ V43 04 51 001	80x50 h.80	Rovere chiaro / Light oak

**Top Bar**

Bar top

	Cm	Colore / Color
■ V43 04 51 T01	80x50 h. 7,3	Rovere chiaro / Light oak
■ V43 04 51 T02	80x50 h. 7,3	Rovere scuro / Dark oak



abert®

ABERT S.p.A.

Via Don P. Mazzolari, 17
25050 Passirano (Bs) Italy

T. 0306853611

F. 0306577194

info@abert.it

www.abert.it



NOVITÀ
20
19









abert





Luna

Inox 18/10 - St. Steel - 5 mm
Cod. CHP..







COD. CHP..		L. Mm
01		200
02		202
05		225
11		193
12		193
15		212
21		140
22		106
38		142











Wave

Inox 18/10 - St. Steel - 1,8 mm
Cod. CHF..

COD. CHF..		L. Mm
01		200
02		202
06		220
21		140
22		106
38		142

Wave Inox

Inox 18/CR - St. Steel - 1,8 mm
Cod. CHD..







COD. CHD..		L. Mm
01		200
02		202
06		220
21		140
22		106
38		142











Blade

Inox 18/10 - St. Steel - 1,8 mm
Cod. CHM..

COD. CHM..		L. Mm
01		200
03		201
06		220
21		141
22		105
38		141

Blade Inox

Inox 18/CR - St. Steel - 1,8 mm
Cod. CHL..

COD. CHL..		L. Mm
01		200
03		201
06		220
21		141
22		105
38		141

Infinito vintage

Inox 18/10 - St. Steel - 2,5 mm
Cod. CV751..



Buffet vintage

Inox 18/10 - St. Steel - 2 mm
Cod. CD551..C



Matisse vintage









Inox 18/10 - St. Steel - 2,5 mm
Cod. CF151..



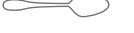

Clever

Inox 18/10 - St. Steel - 4 mm
Cod. CHG..

COD. CHG..		L. Mm
01		200
02		202
05		225
11		193
12		193
15		212
21		140
22		106
38		142





Bacchette sushi Ergo

Ergo sushi chopsticks
 Baguettes à sushi Ergo
 Ergo Sushi stäbchen
 Palillos para sushi Ergo

Inox 18/10 - St. Steel

	Mm	In
903 05 84 660 X	226	8,7/8
Set 2 pz - 2-pc set		
903 05 84 660 K1		
Cartella - Card		

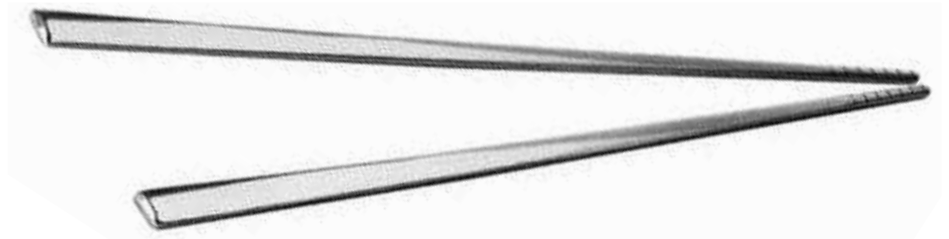
**Poggiabastoncini Ergo**

Ergo Cutlery stand
 Porte - couverts Ergo
 Ergo Besteck Bänke
 Posa cubiertos Ergo

Inox 18/10 - St. Steel

	Mm	In
903 05 84 662	56	2,1/8

**Bacchette sushi Lapis**

Lapis sushi chopsticks
 Baguettes à sushi Lapis
 Lapis Sushi stäbchen
 Palillos para sushi Lapis

Inox/Abs - St. Steel/Abs

	Mm	In
TLA 154 02 82	230	9
Set 2 pz - 2-pc set		

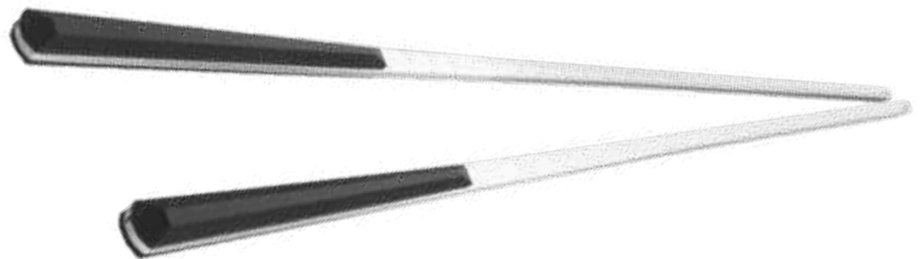
**Poggiabastoncini ABS**

ABS cutlery stand
 Porte - couverts ABS
 ABS Besteck Bänke
 Posa cubiertos ABS

Abs

		Mm	In
118 12 00 081	Trasp.	50x28x12	2x1,1/8x3/8
118 12 00 082	Nero	50x28x12	2x1,1/8x3/8



Poggiabastoncini Branch

Branch cutlery stand
 Porte - couverts Branch
 Branch Besteck Bänke
 Posa cubiertos Branch

Inox 18/10 - St. Steel

	Mm	In
118 05 00 081	30x74	1,1/8x3



Legatovaglioli / poggiabastoncini Bamboo

Bamboo napkin ring / cutlery stand
 Rond de serviettes / porte - couverts Bamboo
 Serviettenhalter / posa cubiertos, Bamboo
 Servilletero / besteck bänke Bamboo

Inox 18/10 - St. Steel

	Mm	H Mm	In	H In
V01 05 81 005	60x35	40	2.3/8x1,3/8	1,1/2

Disegnato da Tianshu Shi e Mengdi Xu



Poggiaposate rotondo

Round cutlery stand
 Porte-couverts rond
 Bestek bänke rund
 Posa cubiertos redondo

Inox 18/10 - St. Steel

	ø Cm	ø In
903 05 84 670	10	3,9



Legatovaglioli tondo

Round napkin ring
 Rond de serviette
 Serviettenhalter
 Servilletero redondo

Inox 18/10 - St. Steel

	ø Mm	ø In
V01 05 81 001	40	1,2/3



Coltello carne Texas

Texas steak knife
 Couteau à bifteck Texas
 Texas Steakmesser
 Cuchillo carne Texas

Acciaio + legno - St. steel + wood

	Mm	In
CAN 55 LC	235	9,1/4

**Coltello carne Memphis**

Memphis steak knife
 Couteau à bifteck Memphis
 Memphis Steakmesser
 Cuchillo carne Memphis

Acciaio + legno - St. steel + wood

	Mm	In
CKO 55 LC	250	9.7/8

**Coltello carne Safari**

Safari steak knife
 Couteau à bifteck Safari
 Safari Steakmesser
 Cuchillo carne Safari

Acciaio + legno - St. steel + wood

	Mm	In
CE5 A5 5LC	235	9,1/4



Porta coppette linea Jambee (adatta a contenere 50 coppette)

Jambee bowl-holder with transparent bowls
 Porte-bols avec bols transparents Jambee
 Glasschalebehälter mit Glasschalen Jambee
 Porta boles con boles transparentes Jambee

Acciaio inox 18/10 - St. steel

	Ø Cm	H. Cm	Ø In	H. In
V77 05 09 C01	15	26,5	5,9	10,3/8



Coppetta per marmellata

Jam bowl
 Bol pour marmelade
 Marmeladeschale
 Bol para marmelada

Vetro - Glass

	Ø Cm	Ø In
V77 08 09 001	6	2,3/8



Cestino porta salse 4 Pezzi

Sauce-jar holder, 4-pc
 Porte-sauces 4 pcs
 Soßenkorb 4pz
 Porta salsas 4 pzs

Acciaio inox 18/10 - St. steel

	Ø Cm	H. Cm	Ø In	H. In
AVARI231	16	25	6,1/4	9,7/8





Cestino pane e frutta Cacao con manico in pelle

Cacao bread and fruit basket - with leather handle
 Corbeille à pain et fruits Cacao - avec anses en cuir
 Cacao Brotkorb und Fruchtkakao - mit Ledergriff
 Cesto de pan y fruta Cacao - con asas de piel

Inox 18/10 + E.P. - St. Steel + E.L.

	Cm	In
V05 05 24 M18	18x18	7x7
V05 05 24 M23	23x23	9x9



Secchio cacao con manico in ecopelle

Cacao bucket with leather handle
 Seau Cacao avec manche en cuir
 Champagnekühler mit Eimer Cacao (Griff aus Leder)
 Cubo Cacao con mango de cuero

Inox 18/10 + E.P. - St. Steel + E.L.

	Ø Cm	H. Cm	Ø In	H. In
V36 05 20 M01	19	19,5	7,1/2	7,5/8



Secchio Cacao con pomolo

Cacao bucket with knob
 Seau Cacao avec poignée
 Champagnekühler Cacao mit Knopf
 Champañera Cacao con pomo

Acciaio inox 18/10 - St. steel

	Ø Cm	H. Cm	Ø In	H. In
V36 05 20 P01	19	19,5	7,1/2	7,5/8

**Supporto secchio Cacao**

Cacao champagne cooler stand
 Support pour seau à champagne Cacao
 Cacao Champagnekühler Ständer
 Soporte para champañera Cacao

Acciaio inox 18/10 - St. steel

	Cm	In
V36 05 20 001	59,5	23,1/2

**Secchio ovale Modern**

Modern Champagne cooler
 Seau à champagne ovale Modern
 Modern oval Champagnekühler
 Champañera oval Modern

Acciaio inox 18/10 - St. steel

	Ø Cm	H. Cm	Ø In	H. In
V78 05 20 003	27	21,5	10,5/8	8,5/1

**Supporto secchio ovale Modern**

Champagne bucket stand
 Support pour seau à champagne
 Sektühlerständer
 Soporte champañera

Acciaio inox 18/10 - St. steel

	Cm	In	Ø Cm	Ø In
V78 05 20 677	59,5	23,1/2	25,5	10



Secchio Modern

Modern Champagne cooler
 Seau à champagne Modern
 Modern Champagnekühler
 Cubo champán Modern

Acciaio inox 18/10 - St. steel

	Ø Cm	H. Cm	Ø In	H. In
V78 05 20 002	24	22,5	9,1/2	8,7/8



Supporto secchio Modern

Modern champagne cooler stand
 Support pour seau à champagne Modern
 Modern Champagnekühler Ständer
 Soporte para cubo champán Modern

Acciaio inox 18/10 - St. steel

	Cm	In
V78 05 20 676	57	22,1/2



Piatto refrigerato

Dish, refrigerated
 Plat réfrigéré
 Servierplatte, gekühlt
 Fuente refrigerada

Acciaio inox 18/10 - St. steel

	Ø Cm	H. Cm	Ø In	H. In
CI 22 600R	32	3,5	12,5/8	1,3/8



Andamento Temperatura

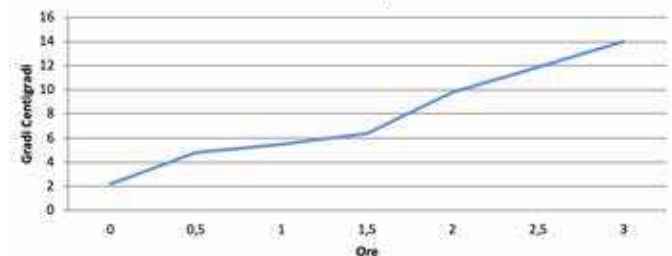

Piatto non refrigerato

Dish, non-refrigerated
 Plat pas réfrigéré
 Servierplatte, nicht gekühlt
 Fuente no refrigerada

Acciaio inox 18/10 - St. steel

	Ø Cm	H. Cm	Ø In	H. In
CI 22 600	32	3,5	12,5	1,3/8



**Vassoio da banco/bar pasticceria**

Bar/pastry tray
Plateau bar/pâtisserie
Konditoreiplatte
Bandeja bar/pastelería

Acciaio inox 18/10 - St. steel

Vassoi adatti a banchi di pasticceria, bar e gastronomia con angolo parete chiuso. Facili da pulire ed igienici.

Trays for pastry, bar & gastronomy counters with closed corners. hygienic and Easy to clean.



	Cm	H. Cm	In	H. In
V01 05 23 P06	35x10 sp	H.0,8	13.3/4x4	0,31



	Cm	H. Cm	In	H. In
V01 05 23 P01	50x10 sp	H.0,8	19,3/4x4	0,31



	Cm	H. Cm	In	H. In
V01 05 23 P02	60x10 sp	H.0,8	23.5/8x4	0,31



	Cm	H. Cm	In	H. In
V01 05 23 P07	25x20 sp	H.0,8	9.7/8x7.7/8	0,31



	Cm	H. Cm	In	H. In
V01 05 23 P08	35x20 sp	H.0,8	13.3/4x7.7/8	0,31



	Cm	H. Cm	In	H. In
V01 05 23 P03	50x20 sp	H.0,8	19.3/4x7.7/8	0,31



	Cm	H. Cm	In	H. In
V01 05 23 P04	60x20 sp	H.0,8	23.5/8x7.7/8	0,31



	Cm	H. Cm	In	H. In
V01 05 23 P05	70x20 sp	H.0,8	27.1/2x7.7/8	0,31

Alzata pasticceria

Petit four stand
Support à pâtisserie
Petits-Fours-Ständer
Presentación pastelería

Acciaio inox 18/10 - St. steel

	Ø Cm	H. Cm	Ø In	H. In
V36 05 41 012	12	13	4,3/4	5,1/8
V36 05 41 016	16	13	6,1/4	5,1/8
V36 05 41 022	22	13	8,5/8	5,1/8

**Alzata pasticceria 2 piani**

2-tier petit four stand
Support à pâtisserie à 2 étages
Petits-fours ständer 2-stufig
Presentación pastelería 2 pisos

Acciaio inox 18/10 - St. steel

	Ø Cm	H. Cm	Ø In	H. In
V36 05 41 201	16-12	17	6,1/4-4,3/4	6.3/4
V36 05 41 202	22-16	17	8,5/8-6,1/4	6.3/4

**Alzata pasticceria 3 piani**

3-tier petit four stand
Support à pâtisserie à 3 étages
Kuchenständer 3-stufig
Presentación pastelería 3 pisos

Acciaio inox 18/10 - St. steel

	Ø Cm	H. Cm	Ø In	H. In
V36 05 41 301	22-16-12	30	8,5/8-6,1/4-4,3/4	11.3/4



abert

ABERT S.p.A.

Via Don P. Mazzolari, 17
25050 Passirano (Bs) Italy
T. 0306853611
F. 0306577194

info@abert.it
www.abert.it

NOVITÀ
20
19

abert



abert[®]

POSATE COLORE 2018

abert[®]

POSATE COLORE 2018





PVD

La tecnica PVD (Physical Vapour Deposition) permette di depositare un film metallico di alto spessore con caratteristiche sorprendenti dal punto di vista decorativo e tecnico. Questo procedimento rende il prodotto trattato durevole nel tempo e conferisce elevata durezza superficiale. L'articolo diventa resistente ai solventi, agli acidi e a vari prodotti usati in cucina, mantenendo intatte le proprie caratteristiche chimico/fisiche. E' un trattamento assolutamente biocompatibile, anallergico ed idoneo al contatto con il cibo.

Polvere di Luna

La finitura Polvere di Luna rende l'aspetto delle posate satinato e delicatamente brillante: una superficie levigata con chiaroscuri. Piacevoli e vellutate al tatto, trasmettono una morbidezza ed un calore inconsueto per oggetti di acciaio. Un rivestimento sobrio ed inusuale per posate contemporanee.

Vintage

L'opacità, i graffi ed i segni volutamente prodotti sulla superficie delle posate con finitura Vintage danno la sensazione di oggetti vissuti ed utilizzati a lungo, di grandi cucine profumate, calde e piene di vapore, di convivialità di altri tempi, di sapori antichi. Evocano immagini di ambienti tradizionali, rustici e senza pretese di modernità.

FINITURE SPECIALI SPECIAL FINISH

PVD

The PVD (Physical Vapour Deposition) technique allows to deposit a high-thickness metal film with remarkable characteristics from the decorative and technical point of view. Such process makes the product treated durable in time and gives high surface hardness. The item turns resistant to solvents, acids and to various products used in the kitchen, keeping its chemical/physical characteristics unchanged. It is a thoroughly biocompatible, anallergic treatment and suitable for food contact.

Polvere di Luna

The Polvere di Luna finish makes cutlery surface look satin-like and delicately brilliant: a smooth surface with contrasting shades. Pleasant and velvety to the touch, the cutlery so treated convey a softness and warmth unusual for steel objects. A sober and unusual coating for contemporary cutlery.

Vintage

Opacity, scratches and marks intentionally made on the surface of the cutlery with a Vintage finish give the effect of objects that have been used for a long time, of a large, warm and steamy kitchen filled with aromas, of the friendly gatherings of old good times and ancient flavours. They evoke images of traditional, simple environments with no intention to be modern.

PVD

Cod. ...41 Oro - Gold
Cod. ...40 Rame - Copper
Cod. ...42 Nero - Black



Finitura disponibile per tutti i modelli
Finish available for all models

Non disponibile per posate a manico cavo
Not available for hollow-handle cutlery

Minimo di ordine 500 pz assortiti
500 assorted pcs minimum order

PVD oro

PVD Gold

Cod. ...41

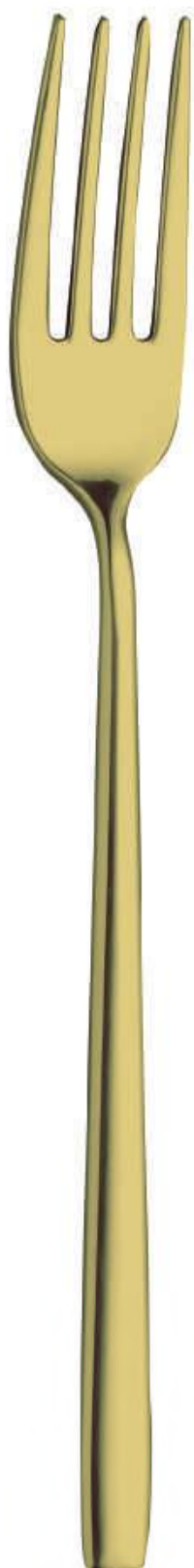
**PVD rame**

PVD Copper

Cod. ...40

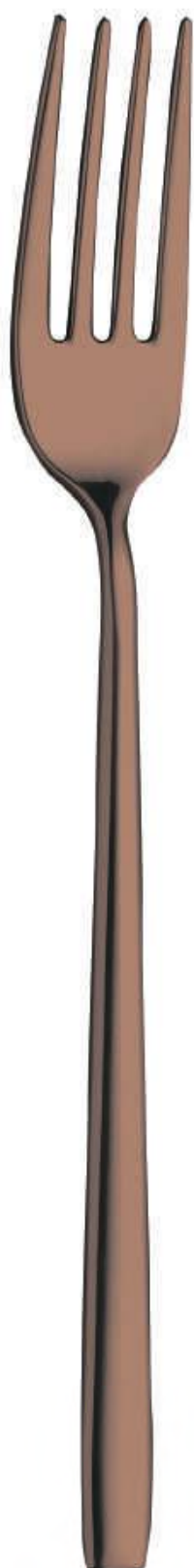
**PVD nero**

PVD Black

Cod. ...42



Polvere di Luna

Cod. ...32

Cod. ...35 Oro - Gold

Cod. ...53 Rame - Copper

Cod. ...39 Nero - Black



Finitura disponibile per tutti i modelli

Finish available for all models

Non disponibile per posate a manico cavo

Not available for hollow-handle cutlery

Minimo di ordine 500 pz assortiti

500 assorted pcs minimum order

Polvere di Luna PVD oro

Moon Dust PVD Gold

Cod. ...35

**Polvere di Luna PVD rame**

Moon Dust PVD Copper

Cod. ...53

**Polvere di Luna PVD nero**

Moon Dust PVD Black

Cod. ...39



Vintage

Cod. ...51

Cod. ...57 Oro - Gold

Cod. ...56 Rame - Copper

Cod. ...58 Nero - Black



Finitura disponibile per tutti i modelli

Finish available for all models

Non disponibile per posate a manico cavo

Not available for hollow-handle cutlery

Minimo di ordine 500 pz assortiti

500 assorted pcs minimum order

Vintage PVD oro

Vintage PVD Gold

Cod. ...57

**Vintage PVD rame**

Vintage PVD Copper

Cod. ...56

**Vintage PVD nero**

Vintage PVD Black

Cod. ...58













Lapis

Acciaio inossidabile / ABS
St. Steel / ABS

Cod. PLA..

01		212	05		223
02		213	21		146

13	15	38	40	47
--	--	--	--	--



Bolero Sublimato

Acciaio inossidabile / Polietilene
St. Steel / Polyethylene

Cod. PC5..

01 

201

05 

221

02 

200

21 

142



In & Out è la nuova linea di posate in nylon vetrificato versatile, informale e colorata che Abert propone per essere utilizzata con creatività, in casa come in giardino, al ristorante o a bordo piscina, al bar o in barca. Date sfogo alla fantasia con le posate In & Out e usatele quando e dove volete e con serenità: sono solide e resistenti, interamente prodotte in Italia, riutilizzabili e lavabili in lavastoviglie.

In & Out is the new glossy-glazed-nylon cutlery, versatile, informal and lively that Abert offers to be used with creativity at home and in the garden, at the restaurant or at the pool side, at the bar or in the boat. Let your imagination run wild with In & Out cutlery and use it when and where you wish and don't be afraid: it is robust and resistant, entirely made in Italy, reusable and washable in dishwasher.



In & Out

Nylon / Polipropilene
Nylon / Polypropylene

Cod. PV8..



01

203



02

201



05

218



21

132



Line N

Acciaio inossidabile / ABS
St.Steel / ABS

Cod. PV9..

01 

200

05 

215

55 

216

02 

205

21 

142

07

13

14

19

24

47



Loira

Acciaio inossidabile / ABS
St. Steel / ABS

Cod. PI2..



01

211



05

230



38

167



02

212



21

156

- 07
- 08
- 12
- 13
- 14



Maya

Acciaio inossidabile / ABS
St.Steel / ABS

Cod. PM8..

01 

202

05 

217

02 

202

21 

146

03

07

12

13

15

19

24

31





47













Mirò

Acciaio inossidabile / ABS + SAN
St.Steel / ABS + SAN

Cod. PT4..

01		223	05		234	38		174
02		225	21		157			

									
---	---	---	---	---	---	---	---	---	---



New Senna

Ghiera metallo
 Acciaio inossidabile / Nylon
 Metal ring
 St.Steel / Nylon

Cod. PV0..



211



230



167



212



156

07

13

14

19

24

47



Vivace

Acciaio inossidabile / ABS + SAN
St.Steel / ABS + SAN

Cod. PT3..



01

194



05

210



02

195



21

131

- 06
- 07
- 12
- 13
- 34
- 44



Nice

Acciaio inossidabile / ABS
St.Steel / ABS

Cod. PT1..

01 

200

05 

215

02 

200

21 

140

10

12

19

34

41

43



Sinuosa Pieno

Acciaio inossidabile / ABS
St. Steel / ABS

Cod. PV7..

- | | | | | | | | | |
|----|---|-----|----|---|-----|----|---|-----|
| 01 |  | 223 | 05 |  | 234 | 26 |  | 233 |
| 02 |  | 225 | 21 |  | 157 | 27 |  | 226 |
| | | | 38 |  | 174 | 39 |  | 243 |



Sinuosa

Acciaio inossidabile / ABS
St. Steel / ABS

Cod. PV7..

01		223	05		234	26		233
02		225	21		157	27		226
			38		174	39		243





B1 B2 B3 B5











Glass

Acciaio inossidabile / ABS
St.Steel / ABS

Cod. PS4..

01		200	05		214
02		199	21		140

							
---	---	---	---	---	---	---	---



One

Acciaio inossidabile / ABS
St.Steel / ABS

Cod. PV6..



190



213



197



132

04

06

07

12

13

15

19

36

47



Master

Acciaio inossidabile / ABS
St.Steel / ABS

Cod. PN9..



194



210



195



131

02

04

06

12

13

15

19

34

43

47



Pashà

Acciaio inossidabile / ABS
St. Steel / ABS

Cod. PC7..

01 

199

05 

203

02 

199

21 

142

04

07

12

13

36



Joker

Acciaio inossidabile / ABS
St.Steel / ABS

Cod. PL8..



199



214



199



137

- 02
- 04
- 07
- 12
- 13



Time

Acciaio inossidabile / ABS
St.Steel / ABS

Cod. PD1..



200



214



200



137

02

04

06

07

12

13

24





Astuccio Lux legno chiaro

Lux wooden box, 16/24-pc (empty)
 Boîte en bois Lux 16/24 pièces (vide)
 Holzschachtel Lux 16/24 Stck (leer), helles Holz
 Caja Lux en madera 16/24 piezas (vacía)

AS77 24 pcs 16/24
 AS77 49 pcs 49



Astuccio Lux legno chiaro

Lux wooden box 75-pc (empty)
 Boîte en bois Lux 75 pièces (vide)
 Holzschachtel Lux 75 Stck (leer), helles Holz
 Caja Lux en madera 75 piezas (vacía)

AS77 75 pcs 75



Astuccio Modern vuoto

Modern case (empty)
 Boîte Modern (vide)
 Geschenkschachtel Modern (leer)
 Caja modern (vacía)

AS78 24 pcs 16/24



Astuccio Modern vuoto

Modern case (empty)
 Boîte Modern (vide)
 Geschenkschachtel Modern (leer)
 Caja modern (vacía)

AS78 75 pcs 75/113



Scatola vetrina Modern ridotta

Window Modern box, small
Boîte a/fenêtre Modern petite
Sichtbare Schachtel Modern klein
Caja vitrina Modern pequeña

AS21 N24E pcs 16/24



Scatola vetrina Modern

Window Modern box
Boîte à fenêtre Modern
Sichtbare Schachtel Modern
Caja vitrina Modern

Dolce colore AS2 90 7DC pcs 7
Servire colore AS2 90 2SC pcs 2



Scatola Elegant Lito

Elegant Lito box
 Boîte Elegant Lito
 Geschenkschachtel Elegant Lito
 Caja Elegant Lito

AS80 24 NERA pcs 24
 AS80 24B KRAFT pcs 24



Minipack bianco

Hanging minipack, white (empty)
 Minipack à accrocher blanc (vide)
 Weiß Minipack zum Hängen (ohne Besteck)
 Mini pack para colgar blanco (vacío)

Pcs 1/2



Lillo Sigillo

Clip Lillo (empty)
 Lillo Clip (vide)
 Lillo Siegel (ohne Besteck)
 Banda adhesiva Lillo (vacío)



Set 24 pezzi

24-pc set
 24 pièces set
 24 Stck set
 Set 24 piezas

Barattolo salvafreschezza multiuso

Riutilizzabile come contenitore per alimenti

Multipurpose freshness container

Reusable as a food container



ABERT S.p.A.

Via Don P. Mazzolari, 17
25050 Passirano (Bs) Italy
T. 0306853611
F. 0306577194

info@abert.it
www.abert.it

abert[®]

HO.RE.CA.

20
19

abert[®]

abert[®]

Abert nasce nel 1929 a Lumezzane, in provincia di Brescia: Antonio Bertoli dà inizio alla sua storia producendo artigianalmente posate in ottone. Negli anni '30 le materie prime utilizzate sono nichel e alluminio e nel 1950 l'acciaio entra stabilmente nei cicli di produzione, prendendo il posto di tutti gli altri materiali. Negli anni '60 verrà introdotta l'automatizzazione produttiva e nel 1975 Abert sarà la prima azienda al mondo ad ingegnerizzare i processi per la produzione di posate colorate con la combinazione di materiali come ABS, nylon e legno. Nel 1987 la sede si trasferisce a Passirano e nel 1993 acquisisce il marchio Facix e lo storico marchio milanese Broggi, leader di mercato nella posateria e nei complementi d'arredo per la tavola nel settore alberghiero. Nel 1994 è la prima azienda del settore ad ottenere la certificazione di qualità ISO 9002. Nel 2000 Abert cresce lanciando un nuovo progetto per il canale l'Ho.Re.Ca. con l'introduzione di una ampia gamma di prodotti professionali alberghieri.

Oggi, quasi novant'anni dopo la sua nascita, ancora guidata dalla famiglia Bertoli alla quarta generazione, Abert continua a puntare sull'innovazione, sulla qualità dei propri prodotti, sulla sensibilità e l'ascolto del cliente e sulla sua capacità di mutare insieme al mercato.

Abert pone da sempre al centro della propria attività valori che considera irrinunciabili: l'eccellenza delle materie prime, determinante per la performance dei propri prodotti, l'innovazione sulla base di processi produttivi e tecnologie d'avanguardia, la qualità dei prodotti che produce nei propri stabilimenti, a Passirano, il design che si traduce nella creazione di oggetti unici e che è alla base dello studio di ogni suo nuovo prodotto.

Per vincere le sfide del futuro Abert investe su se stessa e sui propri valori, che esprime con una forte cultura d'impresa ed azioni concrete, impegnandosi nella tutela e nella difesa dell'ambiente e nell'etica dei rapporti economici e sociali.

STORIA • HISTORY

Abert is founded in 1929 in Lumezzane, in the province of Brescia: Antonio Bertoli starts its story by manufacturing brass cutlery by hand. in the 30's the raw materials used are nickel and aluminium and in 1950 steel enters in the production cycles permanently, replacing all the other materials. in the '60s production automation is introduced and in 1975 Abert is the first company in the world to engineering the processes for the production of colored-handle cutlery with the combination of materials like ABS, nylon and wood. in 1987 the company headquarters move to Passirano and in 1993 Abert acquires the brand Facix and the historical Milanese brand Broggi, market leader in hotel cutlery and tableware. in 1994 it is the first company of the sector to achieve the quality certification ISO 9002. in 2000 Abert grows and launches a new project for the Ho.Re.Ca. channel with the introduction of a wide range of hotel professional products.

Today, almost ninety years after its birth, still led by the Bertoli family on its fourth generation, Abert goes on aiming at innovation, quality of its products, sensitivity and listening to its customers and on its capability of changing with the market.

Abert has always placed at the centre of its activities fundamental values: excellence of raw materials, crucial for the performance of its products, innovation on the base of production processes and state-of-the-art technologies, quality of the products it manufactures in its own factories in Passirano, design, that means creation of unique objects and which is the foundation of every new product.

in order to win the challenges of the future Abert invests on its own and on its values that expresses through a strong enterprise culture and concrete action, committing to protect and defend the environment and the ethics involved in economic and social relationships.

abert[®]

CATALOGO HORECA 2019

POSATE / FLATWARE 5

MODERN	12
CLASSIC	45
BASIC	64
COLOR	82
FINISHING	86

ACCESSORI / ACCESSORIES 97

BREAK&FAST	98
COFFEE&DRINKS	100
TAPAS&APPETIZERS	104
PIZZA&STEAKS	106
MARISCOS&ESCARGOTS	111
CHEESE	112
SERVING	113

BUFFET 123

URBAN	124
MIX&PLAY	142
SQUARE	156
JAMBEE	170
IMPERIAL	174

TAVOLA / HOLLOWWARE 199

ART&TABLE	200
MENAGE	220
RICAMBI	227
LOUNGE&SERVICE	228
CELSIUS	234

WINE&BAR 239

KITCHEN 251

GASTRONORM	252
MANAGE & SERVING	264

PROMAB 271

KITCHEN	272
HOLLOWWARE	280
PACKAGING	288

Superior	12	Style	25	Bella	38	Splendido	50	Reveil	62	Murano Inox	72
Amarcord	13	Linea	26	Brigitte	39	Perla	51	Scozia	63	Luisa	73
Dolce vita	14	Step	27	Naif	40	Vintage	52	Boston	64	Oslo	74
Dream	15	Più	28	Rem	41	Condor	53	Firenze	65	Eva	75
Niagara	16	Marea	29	Pop	42	Baguette	54	River	66	Corsaro	76
Milord	17	Gourmet	30	Mare	43	Silvia	55	Malta	67	America	77
Elegant	18	Cosmos	31	Med	44	Victory	56	Rimini	68	Wave/A	78
Relais	19	Mirage	32	Garda Top	45	Enrico VIII	57	Toronto	69	Wave/A Inox	78
Ego	20	Infinito	33	Hermitage	46	Alaska	58	Toronto Inox	69	Blade	79
Slim	21	Flair	34	Rinascimento	47	Alaska Inox	58	Valencia	70	Blade Inox	79
Ergo	22	Baltic	35	Rada	48	England	59	Valencia Inox	70	New Line	82
Dinamica	23	Monaco	36	Rada Top	48	London	60	Corona	71	In & Out	83
Allegra	24	Matisse	37	Imperial	49	Verve	61	Murano	72	Baltic Abi	84



POSATE • CUTLERY

MODERN (12)

CLASSIC (45)

BASIC (64)

COLOR (82)

FINISHING (86)

Ciclo di produzione

Il ciclo di produzione di forchette e cucchiai inizia con l'operazione di tranciatura (1). Per diminuire lo spessore della tazza rispetto al manico, si procede poi con la laminazione (2), e si prosegue con la rifilatura (3), per dare la forma della tazza o dei rebbi alla posata laminata. Infine si passa alla coniazione (4), nel corso della quale vengono dati la forma e i decori necessari. Per la lavorazione dei coltelli monoblocco forgiati si parte con la tranciatura del tondino in uno spezzone (1), che viene successivamente coniato a caldo (2), in modo da conferirgli una prima forma. Si prosegue con la tranciatura del manico (3) e con l'allungamento della lama (4); in seguito viene effettuata la tranciatura della lama (5), in modo da darle la forma reale. A questo punto rimane da definire la seghettatura sulla lama (6) e rifinire il coltello con le normali operazioni di pulitura. Le fasi di lavorazione dei coltelli a manico cavo forgiati parte con la tranciatura delle valve (1). Le due valve che costituiranno il manico cavo vengono coniate a freddo (2), per dare loro la convessità e i decori, e poi vengono accoppiate e saldate (3): ecco il manico del coltello. Infine, attraverso un composto autobloccante, viene assemblata e saldata al manico la lama (4), prodotta con le stesse tecniche dei coltelli monoblocco forgiati.

Cutlery manufacturing process

Shearing (1) is the first step in the process of manufacturing forks and spoons. Rolling (2) is used to reduce the bowl thickness compared to that of the handle, and the next step is trimming (3) to give the shape of a bowl or prongs to the laminated implement. The final step is coining (4) during which the implement is shaped and ornamentation stamped. To make forged solid-handle knives the process begins by shearing a bar into a blan (1) that is then hot coined (2) so as to give it some initial shape. Afterwards the handle is sheared (3) and the blade is stretched (4). Then, the blade is sheared (5) so that it takes its final shape. Now blade serration (6) needs to be defined and the knife has to be polished as usual. The first step to make forged hollow-handle knives is shearing the shells (1). The two half-shells that will form the hollow handle are cold-coined (2) to obtain the convexity and stamp the decoration; afterwards the shells are coupled and welded (3). And that is how the knife handle is ready. Finally and by using a self-locking compound the blade, made applying the same techniques used to make forged solid-handle knives, is coupled and welded to the handle (4).

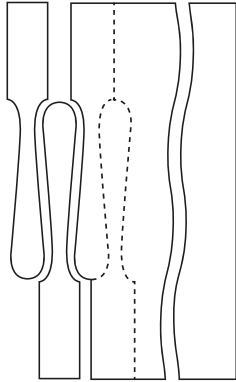

①
Tranciatura
Blank cutting

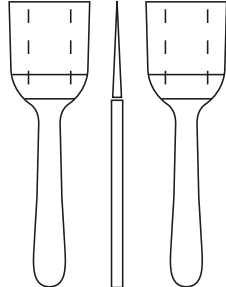

②
Laminazione
Rolling operation

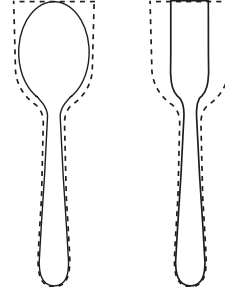

③
Rifilatura
Overall cutting on outside blank

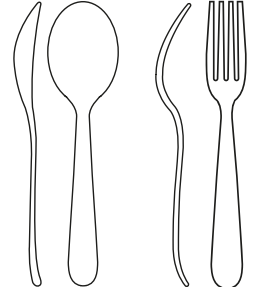

④
Coniatura
Pressing operation

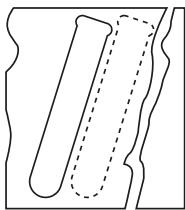

⑤
Tranciatura
Blank cutting



⑥
Coniatura manico
Handle pressing



⑦
Saldatura gocce
Soldering of shells

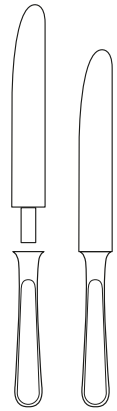

⑧
**Assemblaggio e saldatura
lama manico cavo**
Assembling and soldering
hollow handle knife



⑨
Tranciatura spezzone
Rod cutting



⑩
Coniatura a caldo
Forging

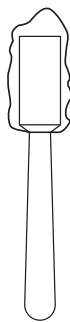

⑪
Tranciatura manico
Blank cutting of the blade

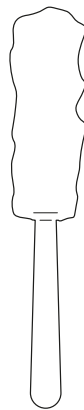

⑫
Laminazione
Rolling of the blade

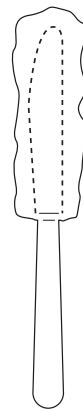































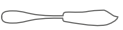













⑬
Ritanciatura lama
2nd blank cutting
of the blade



⑭
Seghettatura e finitura
Blade grinding
and finishing

TABELLA POSATE

01		Cucchiaino tavola Table spoon Cullière de table Eßlöffel Cuchara mesa
02		Forchetta tavola Table fork Fourchette de table Eßgabel Tenedor mesa
03		Cucchiaino brodo Bouillon spoon Cullière à soupe Suppenlöffel Cuchara sopa
04		Coltello tavola forgiato pesante Table knife heavy-forged Couteau de table forgé lourd Tafelmesser-schwer Cuchillo mesa forjado pesado *
05		Coltello tavola forgiato Table knife-forged Couteau de table forgé Tafelmesser Cuchillo mesa forjado *
05R		Coltello tavola Reverse Reverse table knife-forged Couteau de table Reverse Tafelmesser Reverse Cuchillo mesa Reverse forjado *
06		Coltello tavola leggero Table knife-light Couteau de table léger Tafelmesser-leicht Cuchillo mesa ligero *
08		Coltello tavola m/v saldato Table knife - welded hollow-handle Couteau de table poignée creuse soudée Tafelmesser mit Hohlheft Cuchillo mesa mango hueco soldado *
11		Cucchiaino frutta Dessert spoon Cuillère à dessert Dessertlöffel Cuchara postre
12		Forchetta frutta Dessert fork Fourchette à dessert Dessertgabel Tenedor postre
14		Coltello frutta forgiato pesante Dessert knife-heavy forged Couteau à dessert forgé lourd Dessertmesser-schwer Cuchillo postre forjado pesado *
15		Coltello frutta forgiato Dessert knife-forged Couteau à dessert forgé Dessertmesser Cuchillo postre forjado *
15R		Coltello frutta Reverse forgiato Dessert knife forged-Reverse Couteau à dessert Reverse forgé Dessertmesser Reverse Cuchillo postre Reverse forjado *
16		Coltello frutta leggero Dessert knife-light Couteau à dessert léger Dessertmesser-leicht Cuchillo postre ligero *
18		Coltello frutta m/v saldato Dessert knife-welded hollow-handle Couteau à dessert poignée creuse soudée Dessertmesser mit Hohlheft Cuchillo postre mango hueco soldado *
21		Cucchiaino caffè Tea spoon Cuillère à café Kaffeelöffel Cuchara café
22		Cucchiaino moka Moka spoon Cuillère à moka Mokkalöffel Cuchara moka
23		Cucchiaino zucchero Sugar spoon Cuillère à sucre Zuckerlöffel Cuchara azucar
25		Mestolo servire Soup ladle Louche Rührlöffel Cazo sopa
26		Forchettone servire Serving fork Fourchette à servir Vorlegegabel Tenedor servir
27		Cucchiaione servire Serving spoon Cuillère à servir Vorlegelöffel Cucharón servir
28		Cucchiaione insalata Salad serving spoon Cuillère à servir salade Salatlöffel Cucharón servir ensalada
29		Forchettone insalata Salad serving fork Fourchette à servir salade Salatgabel Tenedor servir ensalada
30		Cucchiaione riso Salad serving spoon Cuillère à servir salade Salatlöffel Cucharón servir ensalada
31		Forchetta pesce Fish fork Fourchette à poisson Fischgabel Tenedor pescado
32		Coltello pesce Fish knife Couteau à poisson Fischmesser Cuchillo pescado
33		Forchettone servire pesce Fish serving fork Fourchette à servir poisson Servierfischgabel Tenedor servir pescado
34		Coltello servire pesce Fish serving knife Couteau à servir poisson Servierfischmesser Cuchillo servir pescado
35		Cucchiaino bibita Ice tea spoon Cuillère à cocktail Cocktaillöffel Cuchara refresco
36		Cucchiaino fragola confetto Sweets spoon Cuillère à bonbons Bonbonlöffel Cuchara caramelos
37		Paletta gelato Ice cream spoon Cuillère à glace Speiseeislöffel Cuchara helado
38		Forchettina dolce Cake fork Fourchette à tarte Kuchengabel Tenedor lunch
39		Pala dolce Cake server Pelle à tarte Tortenschaufel Pala pastel
40		Coltellone dolce Cake knife Gros couteau à tarte Tortenmesser Cuchillo pastel
41		Coltellone torta seghettato Cake knife with serrated blade Couteau à tarte lame denteleé Kuchenmesser Cuchillo pastel dentado
42		Mestolino salsa Sauce ladle Louche à sauce Soßeschöpflöffel Cacillo salsa
43		Spalmaburro Butter spreader Couteau à beurre Buttermesser Pala mantequilla
45		Spalmaburro Butter spreader Couteau à beurre Buttermesser Pala mantequilla
53		Spalmaburro forgiato Butter spreader - forged Couteau à beurre forgé Buttermesser Pala mantequilla forjado *
55		Coltello bistecca Steak knife Couteau à bifteck Filetmesser Cuchillo carne *
63		Forchetta lumache 2 punte 2 prongs snail fork Forchette à escargots à deux dents Zweizinkengabel für Schnecke Tenedor caracoles dos puntas
64		Forchettina ostriche Oyster fork Forchette à crustacés Auster Krustazeengabel Tenero mariscos
67		Cucchiaino salsa Sauce spoon Cuillère à sauce Soßelöffel Cuchara salsa
68		Cucchiaino bimbo Baby spoon Cuillère enfant Kinderlöffel Cuchara niño
69		Forchetta bimbo Baby fork Fourchette enfant Kindergabel Tenedor niño
70		Coltello bimbo Baby knife Couteau enfant Kindermesser Cuchillo niño *
80		Cucchiaino lunch Lunch spoon Cuillère à lunch Lunchlöffel Cuchara lunch

* materiale: acciaio inossidabile | material: stainless steel |
matériel: acier inoxydable | Material: aus Edelstahl | material: acero inoxidable

Istruzioni d'uso e di manutenzione per la posateria e il vasellame in acciaio inox

Lavare accuratamente i prodotti nuovi prima di utilizzarli. Utilizzare per il lavaggio acqua calda ed un buon sapone neutro, risciacquare in seguito con abbondante acqua tiepida ed asciugare scrupolosamente tutti gli articoli.

Non utilizzare per il lavaggio detersivi sintetici a base di cloro o prodotti comunque candeggianti.

Pomice, paglietta d'acciaio, spugnette o panni impregnati di polveri abrasive devono essere altresì rigorosamente esclusi. Possono invece essere utilizzati detersivi non clorurati contenente farina fossile.

E' consigliato il lavaggio degli articoli in acciaio inox subito dopo il loro utilizzo. Qualora questo non fosse possibile è comunque importante non lasciare per più di 12 ore gli articoli sporchi a contatto con i residui alimentari (es: in caso di utilizzo degli articoli a pranzo, andrebbero lavati entro la sera del giorno stesso; in caso di utilizzo degli articoli a cena, andrebbero lavati entro la mattina del giorno seguente).

Nel caso fosse necessario un prelavaggio, questo deve essere fatto appena prima del lavaggio e per un tempo relativamente breve. Gli articoli non vanno infatti lasciati in ammollo nella soluzione lavante per troppo tempo in quanto alcune sostanze contenute negli alimenti sono dannose per l'acciaio inox e ne alterano l'aspetto.

I coltelli e le lame dei coltelli (in caso di articolo a manico cavo) prodotte con un pregiato acciaio inossidabile, sono sensibili agli attacchi corrosivi sviluppati dall'acido acetico, citrico, lattico ed in particolare da cloruro di sodio, presenti negli alimenti.

E' importante, sia in fase di prelavaggio che durante il lavaggio, tenere separate le normali posate (cucchiai, forchette, cucchiaini) dai coltelli e da altri oggetti metallici presenti in cucina.

Nel caso di lavaggio in lavastoviglie le posate devono essere inserite in cestelli verticali di plastica e tenute separate dai coltelli.

Asciugare accuratamente gli articoli con un panno morbido subito dopo il lavaggio, anche se il lavaggio è eseguito in lavastoviglie che prevede un ciclo di asciugatura automatica. Questo è necessario per evitare l'eventuale formazione di macchie dovute a depositi calcarei contenuti nell'acqua.

Non lasciare le posate nell'ambiente umido della lavastoviglie una volta terminato il ciclo di lavaggio, ma asciugarle e riporle in un ambiente asciutto.

Si consiglia di conservare gli articoli perfettamente asciutti, in un ambiente privo di umidità.

Per evitare rigature si consiglia di non conservare alla rinfusa gli articoli ma di riporli ordinatamente e proteggerli con un panno morbido.

Instructions for use and maintenance of stainless steel cutlery and hollowware

Wash the new products carefully before use.

Use hot water to wash them and a good neutral detergent; then, rinse out with lukewarm water and dry all the items thoroughly.

When washing, do not use chlorinated detergents nor products containing bleach.

Pumice, steel wool, sponges or cloths saturated with abrasive powders must be strictly avoided. However, detergents without chloride containing fossil flour can be used.

The washing of stainless steel items after use is recommended. In case that would not be possible, it is however important not to leave for more than 12 hours the dirty items in contact with food leftovers (e.g.: if the items are used at lunch, they should be washed within the evening; if the items are used at dinner, they should be washed within the following morning).

In case a prewash was needed, it must be carried out just before the washing and for a relatively short time. In fact, the items must not be soaked in the washing solution for too long, since some substances contained in food are damaging for the stainless steel and change its appearance. Knives and knife blades (for hollow

handle items) are manufactured with a valuable stainless steel and are sensitive to the corrosion attacks developed by acetic, citric and lactic acid and in particular to sodium chloride present in food.

It is important, both when pre-washing and washing, to keep cutlery like spoons, forks and tea spoons, separated from knives and other metal kitchenware.

In case of washing in dishwasher, spoons and forks must be placed into plastic vertical baskets and kept separated from knives.

Dry the items thoroughly immediately after the washing with a soft cloth, even if your dishwasher has a dry cycle.

That is necessary in order to avoid the possible formation of stains caused by calcareous deposits contained in the water.

Do not leave the cutlery in the humid environment of the dishwasher once the washing finishes; dry them and store them in a dry place.

It is recommended to storage the items perfectly dried and in a location without humidity.

In order to avoid scratches, it is recommended not to keep the items randomly, but if it is possible, to protect them by soft cloth.











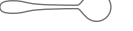

Superior

Inox 18/10 - St. Steel - 4 mm
Cod. CZ4..



COD. CZ4..

L. Mm

01	
02	
03	
05	
11	
12	
15	
21	
22	
31	
32	
38	

205

206

175

235

185

186

210

137

107

180

200

143



Amarcord

Inox 18/10 - St. Steel - Forg.
Cod. CC2..

COD. CC2..		L. Mm
01		214
02		214
03		193
05		235
11		193
12		193
15		212
21		150
22		113
25		305
26		247
27		247
31		185
32		206
38		148
39		251
53		176
55		230











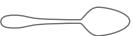

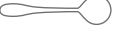



Dolce vita

Inox 18/10 - St. Steel - Forg.
Cod. CB8..



COD. CB8..











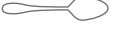

L. Mm

01		214
02		214
03		214
05		235
11		193
12		193
15		212
21		150
22		113
25		305
26		247
27		247
31		186
32		203
38		148
39		251



Dream

Inox 18/10 - St. Steel - Forg.
Cod. CF9..

COD. CF9..		L. Mm
01		208
02		208
05		235
11		187
12		187
15		210
21		145
22		115
26		239
27		239
30		254
32		198
38		145
39		248













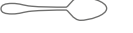

Niagara

Inox 18/10 - St. Steel - Forg.
Cod. CZ3..



COD. CZ3..

L. Mm

01		210
02		203
05		231
11		181
12		183
15		210
21		142
22		113
25		306
26		237
27		234
38		160
39		250
53		175
55		228



Milord

Inox 18/10 - St. Steel - 4 mm
Cod. C14..

COD. C14..	L. Mm
01	197
02	198
03	172
05	233
08	225
11	177
12	178
15	195
18	200
21	133
22	104
25	310
26	228
27	227
31	198
32	212
35	195
36	172
37	129
38	143
39	240
42	175
53	168
55	230
67	184

Elegant

Inox 18/10 - St. Steel - 4 mm
Cod. CV6..



COD. CV6..



L. Mm
210



210



185



235



236



185



185



210



204

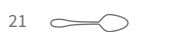

142

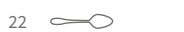

114



314



231



229



182



197



145



240



















175



Relais

Inox 18/10 - St. Steel - 4 mm
Cod. CU3..

COD. CU3..		L. Mm
01		210
02		212
03		185
05		235
11		187
12		192
15		212
21		135
22		112
25		305
26		240
27		240
31		185
32		197
38		143
39		247
53		176
55		230













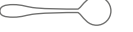



Ego

Inox 18/10 - St. Steel - 4 mm
Cod. CD3..



COD. CD3..













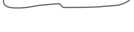



L. Mm

01		207
02		207
03		182
05		231
11		186
12		186
15		209
21		145
22		114
25		306
26		237
27		234
30		278
32		215
38		150
39		250



Slim

Inox 18/10 - St. Steel - 4 mm
Cod. CU7..

COD. CU7..	L. Mm
01 	214
02 	214
03 	193
05 	235
11 	193
12 	193
15 	212
21 	150
22 	113
25 	305
26 	247
27 	247
31 	200
32 	214
38 	148
39 	251
53 	176
55 	230

Ergo

Inox 18/10 - St. Steel - 4 mm
Cod. CE5..



COD. CE5..

L. Mm



207



207



182



231



186



186



209



145

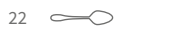

114



306



237



234



215



150



250



175

















228



Dinamica

Inox 18/10 - St. Steel - 3 mm
Cod. CM7..

COD. Cm7..		L. Mm
01		206
02		206
05		235
11		190
12		180
15		210
21		133
22		110
25		290
26		241
27		241
31		206
32		213
38		160
39		241

Allegra

Inox 18/10 - St. Steel- 3 mm
Cod. CM6..



COD. CM6..



203



201



229



180



180



203



140

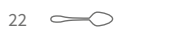

106



155



176

















230

L. Mm



Style

Inox 18/10 - St. Steel - 3 mm
Cod. CD6..

COD. CD6..		L. Mm
01		202
02		202
05		230
11		182
12		182
15		208
21		140
22		108
25		310
26		232
27		233
32		201
38		146
39		246















Linea

Inox 18/10 - St. Steel - 3 mm
Cod. CF7..



COD. CF7..

L. Mm

01		215
02		217
05		231
11		194
12		195,5
15		210
21		155
22		116
25		305
26		255
27		258
32		212
38		155
39		239



Step

Inox 18/10 - St. Steel - 3 mm
Cod. CF8..

COD. CF8..		L. Mm
01		200
02		200
03		178
05		230
11		179
12		181
15		207
21		140
22		109,7
26		231
27		234
30		260
31		180
32		193
38		146
39		255













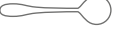
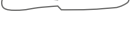

Più

Inox 18/10 - St. Steel - 3 mm
Cod. CD7..



COD. CD7..













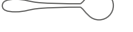
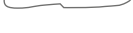



L. Mm

01		210
02		210
03		180
05		230
11		190
12		190
15		207
21		148
22		114
25		305
26		239
27		239
32		218
38		147
39		251
53		175



Marea

Inox 18/10 - St. Steel - 3 mm
Cod. CE4..

COD. CE4..		L. Mm
01		202
02		202
03		169
05		235
11		173
12		175
15		210
21		134
22		117
25		285
26		232
27		230
32		202
35		210
38		155
39		249
53		175











Gourmet

Inox 18/10 - St. Steel - 3 mm
Cod. CF5..



COD. CF5..

L. Mm

01	
02	
05	
11	
12	
15	
21	
22	
38	
55	

195

198

227

195

177

202

131

103















153

219



Cosmos

Inox 18/10 - St. Steel - 2,5 mm
Cod. C06..

COD. C06..		L. Mm
01		197
02		199
05		213
11		177
12		179
15		200
21		130
22		108
25		305
26		230
27		225
35		197
38		150
39		242
42		178



















Mirage

Inox 18/10 - St. Steel - 2,5 mm
Cod. C17..



COD. C17..

L. Mm

01		197
02		200
05		213
06		223
11		178
12		179
15		199
21		135
22		110
25		314
26		230
27		229
31		203
32		222
35		210
38		159
39		247
55		210











Infinito

Inox 18/10 - St. Steel- 2,5 mm
Cod. CV7..

COD. CV7..

L. Mm

01		207
02		207
05		231
11		186
12		186
15		209
21		145
22		114
38		150

Flair

Inox 18/10 - St. Steel - 2,5 mm
Cod. C02..



COD. C02..

L. Mm

01  197

02  200

05  213

11  178

12  179

15  199

21  135

22  110

25  314

26  230

27  229

31  203

32  222

38  159

39  247















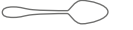





53  175

55  220

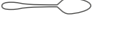

Baltic

Inox 18/10 - St. Steel - 2,5 mm
Cod. CB6..

COD. CB6..		L. Mm
01		195
02		195
05		216
06		215
11		181
12		176
15		192
21		134
22		105
25		307
26		233
27		232
28		223
29		221
32		208
35		209
38		140
39		244
63		158
COD. CB6KO..		L. Mm
68		151
69		151
70		166











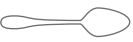



Monaco

Inox 18/10 - St. Steel - 2,5 mm
Cod. C34..

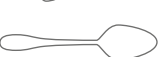

COD. C34..

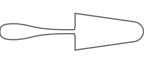
L. Mm

01		196
02		195
05		211
11		170
12		173
15		190
21		131
22		110
27		223
31		195
32		205
38		155
39		238
42		???



Matisse

Inox 18/10 - St. Steel - 2,5 mm
Cod. CF1..

COD. CF1..		L. Mm
01		204
02		205
03		168
05		230
11		178
12		178
15		208
21		137
22		110
25		295
26		240
27		237
31		203
32		210
35		207
37		133
38		153
39		238
42		170
53		178
55		230
63		156
64		156
80		158

Bella

Inox 18/10 - St. Steel - 2,2 mm
Cod. CE3..



COD. CE3..



L. Mm
204



204



175



230



183



183



207

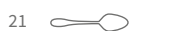

143

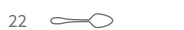

112



270



236



236













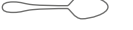



143



Brigitte

Inox 18/10 - St. Steel - 2 mm
Cod. C68..

COD. C68..		L. Mm
01		195
02		197
06		213
11		178
12		177
16		190
21		131
22		103
25		315
26		230
27		226
31		190
32		210
38		153
39		240

Naif

Inox 18/10 - St. Steel - 1,8 mm
Cod. CE8..



COD. CE8..



L. Mm
200



202



220



136



155



Rem

Inox 18/10 - St. Steel - 1,8 mm
Cod. C89..

COD. C89..		L. Mm
01		201
02		200
05		223
15		197
21		141
22		111
25		285
26		234
27		235
35		208
38		141
39		226
80		161









Pop

Inox 18/10 - St. Steel - 1,8 mm
Cod. CD4..



COD. CD4..











L. Mm

01		201
02		200
05		212
06		210
21		141
22		111
35		208
38		141



Mare

Acciaio inossidabile - St. Steel - 3 mm
Cod. CN8..

COD. CN8..		L. Mm
01		202
02		202
05		222
11		173
12		175
15		191
21		134
22		117
38		155
53		175
80		144

Med

Acciaio inossidabile - St. Steel - 2,2 mm
Cod. CT1..



COD. CT1..



204



205



230



137



110













Garda Top

Inox 18/10 - St. Steel - 4 mm
Cod. C82T..



COD. C82T..

L. Mm

01		210
02		210
05		235
11		184
12		184
15		212
21		140
22		110
32		220
38		150











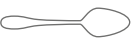

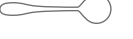
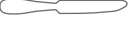



Hermitage

Inox 18/10 - St. Steel - 5 mm
Cod. C09..

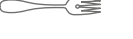

COD. C09..











L. Mm

01		202
02		201
03		178
05		228
11		182
12		181
15		205
21		142
22		107
25		312
26		262
27		258
31		200
32		215
38		146
39		252
42		180
53		175























Rinascimento

Inox 18/10 - St. Steel - 3 mm
Cod. CHA..

COD. CHA..		L. Mm
01		198
02		200
03		170
05		235
11		176
12		179
15		210
21		133
22		107
38		154

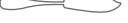







Rada

Inox 18/10 - St. Steel - 3 mm
Cod. C29..

COD. C29..	L. Mm
01 	208
02 	206
03 	175
04 	236
05 	230
11 	187
12 	187
14 	216
15 	210
21 	142
22 	141
25 	300
26 	227
27 	225
31 	182
32 	201
35 	139
37 	152
38 	142
39 	240
55 	220

Rada Top

Inox 18/10 - St. Steel - 4 mm
Cod. C29T..

COD. C29T..	L. Mm
01 	206
02 	207
04 	236
11 	187
12 	188
14 	216
21 	140
22 	110
38 	150



Imperial

Inox 18/10 - St. Steel - 3 mm
Cod. C04..



COD. C04..		L. Mm
01		207
02		208
03		174
05		239
08		247
11		187
12		188
15		216
18		214
21		141
22		111
23		116
25		315
26		239
27		239
28		206
29		205
31		186
32		210
33		242
34		260
35		192
36		174
37		133
38		145
39		240
40		255
42		164
53		170
55		220
67		188

Splendido

Inox 18/10 - St. Steel - 3,5 mm
Cod. C19..



COD. C19..

L. Mm

01  201

02  200

03  178

05  218

11  180

12  180

15  201

21  140

22  106

25  303

26  230

27  229

31  200

32  214

38  148

39  242

42  179

43  170



Perla

Inox 18/10 - St. Steel - 3 mm
Cod. CZ1..

COD. CZ1..		L. Mm
01		200
02		201
03		176
05		235
11		180
12		180
15		204
21		140
22		104
31		197
32		208
38		152

Vintage

Inox 18/10 - St. Steel - 3 mm
Cod. CB5..



COD. CB5..

01 

208

02 

206

05 

229

11 

187

12 

187

15 

206

21 

142

22 

117

25 

300

26 

227

27 

225

31 

181

32 

202

38 

152

39 

242

40 

237

55 











203

L. Mm



Condor

Inox 18/10 - St. Steel - 2,5 mm
Cod. C18..













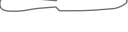
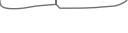







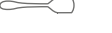

COD. C18..		L. Mm
01		196
02		194
05		212
11		170
12		173
15		197
21		130
22		110
26		227
27		223
38		155

Baguette

Inox 18/10 - St. Steel - 2,5 mm
Cod. CP1..

COD. CP1..

L. Mm

01		205
02		205
03		169
05		246
08		225
11		179
12		179
15		195
18		200
21		143
22		110
25		295
26		239
27		236
31		205
32		211
35		207
37		133
38		154
39		238
42		172
45		178
53		175
55		212
67		179





Silvia

Inox 18/10 - St. Steel - 2,5 mm
Cod. CP7..

COD. CP7..		L. Mm
01		207
02		206
05		226
11		179
12		179
15		212
21		139
22		112
25		292
26		227
27		227
31		181
32		205
33		221
34		241
38		150
39		268
42		183

Victory

Inox 18/10 - St. Steel - 2,5 mm
Cod. CP2..

COD. CP2..



L. Mm
203



204



167



221



214



247



178



179



208



191



214

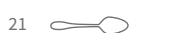

137

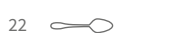

110



299



239



236



203



210



206



132



153



235



170



177



170



227













160

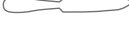























Enrico VIII

Inox 18/10 - St. Steel - 2,5 mm
Cod. CUB..

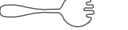
COD. CUB..		L. Mm
01		205
02		204
03		168
05		220
11		186
12		184
15		200
21		137
22		121
31		182
32		193
38		142









Alaska

Inox 18/10 - St. Steel - 2,2 mm
Cod. C24..

COD. C24..	L. Mm
01 	195
02 	195
05 	209
06 	212
11 	175
12 	176
15 	190
16 	190
21 	137
22 	103
25 	314
26 	223
27 	223
28 	207
29 	206
35 	208
37 	134
38 	152
39 	224
40 	223
42 	175

Alaska Inox

Inox 18/CR - St. Steel - 1,8 mm
Cod. CG3..

COD. CG3..	L. Mm
01 	195
02 	195
*06 	212
21 	128
22 	117
35 	208
37 	134
38 	175

*C2406L













England

Inox 18/10 - St. Steel - 2,2 mm
Cod. C97RO..



COD. C97RO..

L. Mm

01		203
02		201
05		229
11		180
12		180
15		203
21		140
22		106
38		144
39		245

London

Inox 18/10 - St. Steel - 2,2 mm
Cod. CP3..



COD. CP3..



L. Mm

203



204



220



177



177



209



137



110



304



237



237



152



234



237









177

Verve

Inox 18/10 - St. Steel - 1,8 mm
Cod. C37..

**COD. C37..****L. Mm**

01		199
02		200
03		166
06		212
21		140
22		105
38		145

Reveil

Inox 18/10 - St. Steel - 1,8 mm
Cod. C30..



COD. C30..

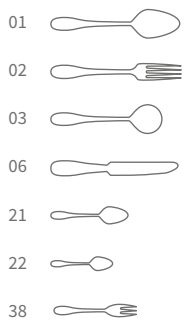









L. Mm

200
200
170
212
140
105
145

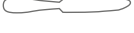

Scozia

Inox 18/CR - St. Steel - 3,0 mm
Cod. CN6..

COD. CN6..		L. Mm
01		200
02		200
05		218
11		180
12		180
15		203
21		138
22		105
38		143













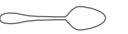





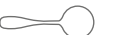

Boston

Inox 18/10 - St. Steel - 2,5 mm
 Manico satinato - Mat finishing handle
 Cod. C39..

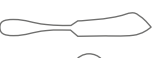

COD. C39..

L. Mm

01		195
02		196
05		213
11		173
12		177
15		192
21		132
22		116
25		308
26		225
27		222
28		203
29		205
31		190
32		204
35		206
37		131
38		153
39		240
40		259
42		185











Firenze

Inox 18/10 - St. Steel - 2,5 mm
Cod. C84..

COD. C84..

L. Mm

01		195
02		196
05		208
11		173
12		175
15		194
21		132
22		116
38		152

River

Inox 18/10 - St. Steel - 2,2 mm
Cod. CV9..



COD. CV9..



195



194



229



172



174



191



129



111

















153



Malta

Inox 18/10 - St. Steel - 1,8 mm
Cod. C60..









COD. C60..		L. Mm
01		194
02		193
05		215
11		174
12		175
15		194
21		122
22		102
25		298
26		224
27		222
38		141
39		244
42		167

Rimini

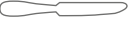
Inox 18/10 - St. Steel - 2 mm
 Manico satinato - Mat finishing handle
 Cod. C45..











COD. C45..

		L. Mm
01		195
02		194
05		229
11		172
12		174
15		191
21		129
22		111
38		153

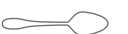









Toronto

Inox 18/10 -- St. Steel - 2,0 mm
Cod. CH8..

COD. CH8..		L. Mm
01		195
02		196
05		213
11		173
12		177
15		192
21		132
22		116
38		153

Toronto Inox

Inox 18/CR - St. Steel - 1,8 mm
Cod. CG8..















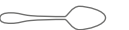



COD. CG8..		L. Mm
01		195
02		196
* 05		213
21		132
22		116
35		206
37		131
38		153

Valencia

Inox 18/10 - St. Steel - 1,8 mm
Cod. CR9..

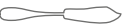
COD. CR9..

L. Mm

01		195
02		198
03		169
05		224
06		215
11		177
12		179
15		209
16		192
21		138
22		110
25		298
26		240
27		236
31		198
32		201
35		207
37		135
38		154











Valencia Inox

Inox 18/CR - St. Steel - 1,8 mm
Cod. CG2..

COD. CG2..

L. Mm









01		195
02		198
*06		215
21		138
22		110
35		207
37		135
38		154

*CR906

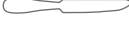
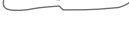
Corona







Inox 18/10 - St. Steel - 1,8 mm
Cod. CS0..



COD. CS0..		L. Mm
01		195
02		198
03		169
05		221
06		215
11		177
12		179
15		207
21		138
22		110
38		154







Murano

Inox 18/10 - St. Steel - 1,8 mm
Cod. CD5..

COD. CD5..		L. Mm
01		199
02		201
06		211
21		140
22		105
38		145

Murano Inox

Inox 18/CR - St. Steel- 1,8 mm
Cod. CG5..

COD. CG5..		L. Mm
01		199
02		201
* 06		211
21		140
22		105
35		187
38		145











*CD506





Luisa

Inox 18/10 - St. Steel - 1,8 mm
Cod. CS4..

COD. CS4..		L. Mm
01		193
02		196
06		212
11		179
12		180
16		190
21		130
22		124
35		187
37		134
38		145

Oslo

Inox 18/CR - St. Steel - 2 mm
 Manico satinato - Mat finishing handle
 cod. C49..



COD. C49..

L. Mm



192



192



210



174



177



190



127



113



283



233



226











151



Eva

Inox 18/CR - St. Steel - 1,5 mm
Cod. CT4E..

COD. CT4E..	L. Mm
01 	194
02 	193
06 	209
21 	129
22 	110
35 	207
37 	134
38 	154

Corsaro

Inox 18/CR - St. Steel - 1,5 mm
Cod. CV1..



COD. CV1..

L. Mm



195



195



212



130



103

















159









America

Inox 18/CR - St. Steel - 1,5 mm
Cod. C46..

COD. C46..	L. Mm
01 	193
02 	193
05 	210
06 	212
11 	173
12 	170
15 	190
16 	190
21 	120
22 	102
26 	222
27 	221
38 	141
55 	215

Wave/A







Inox 18/10 - St. Steel - 1,8 mm
Cod. CHF..

COD. CHF..		L. Mm
01		200
02		202
06		220
21		140
22		106
38		142



Wave/A Inox







Inox 18/CR - St. Steel - 1,8 mm
Cod. CHD..

COD. CHD..		L. Mm
01		200
02		202
06		220
21		140
22		106
38		142









Blade

Inox 18/10 - St. Steel - 1,8 mm
Cod. CHM..

COD. CHM..		L. Mm
01		200
03		201
06		220
21		141
22		105
38		141

Blade Inox

Inox 18/CR - St. Steel - 1,8 mm
Cod. CHL..

COD. CHL..		L. Mm
01		200
03		201
06		220
21		141
22		105
38		141

Bacchette sushi

Sushi chopsticks
 Baguettes à sushi
 Sushi stäbchen
 Palillos para sushi

Inox 18/10 - St. Steel

	Mm	In
903 05 84 660	226	8,7/8
903 05 84 660 K1	cartella	

**Poggiabastoncini**

Cutlery stand
 Porte - couverts
 Posa cubiertos
 Besteck bänke

Inox 18/10 - St. Steel

	Mm	In
118 05 00 081	30x74	1,1/8x3

Acciaio Argentato - Electro-plated St. Steel (EPSS)

	Mm	In
118 07 00 081	30x74	1,1/8x3

**Poggiabastoncini**

Cutlery stand
 Porte - couverts
 Posa cubiertos
 Besteck Bänke

Inox 18/10 - St. Steel

	Mm	In
903 05 84 662	6x6x56	1/4x1/4x2,1/8



Bacchette sushi Lapis

Lapis sushi chopsticks
 Baguettes à sushi Lapis
 Lapis Sushi stäbchen
 Palillos para sushi Lapis

Inox/Abs - St. Steel/Abs

	Mm	In
PLA 15 82	230	9

**Poggiabastoncini**

Cutlery stand
 Porte - couverts
 Posa cubiertos
 Besteck Bänke

Abs

		Mm	In
1181 20 00 81	Trasp.	50x28x12	2x1,1/8x3/8
1181 20 00 82	Nero	50x28x12	2x1,1/8x3/8

**Legatovaglioli / poggiabastoncini Bamboo**

Bamboo napkin ring / Cutlery stand
 Rond de serviettes / porte - couverts Bamboo
 Serviettenhalter / posa cubiertos, Bamboo
 Servilletero / besteck bänke Bamboo

Inox 18/10 - St. Steel

	Cm	H cm
V01 05 81 005	6x3,5 Cm	4







New Line

Inox 18/10 / ABS - St. Steel / ABS - 2 mm
Cod. PV9..

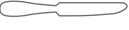

COD. PV9..

L. Mm

01		200
02		205
05		215
21		142
55		216



07



13



14



19



24



47







In & Out

Nylon / PP
Cod. PV8..

In & Out è la nuova linea di posate in nylon vetrificato versatile, informale e colorata che Abert propone per essere utilizzata con creatività, in casa come in giardino, al ristorante o a bordo piscina, al bar o in barca. Date sfogo alla fantasia con le posate In & Out e usatele quando e dove volete e con serenità: sono solide e resistenti, interamente prodotte in Italia, riutilizzabili e lavabili in lavastoviglie.

In & Out is the new glossy-glazed-nylon cutlery, versatile, informal and lively that Abert offers to be used with creativity at home and in the garden, at the restaurant or at the pool side, at the bar or in the boat. Let your imagination run wild with In & Out cutlery and use it when and where you wish and don't be afraid: it is robust and resistant, entirely made in Italy, reusable and washable in dishwasher.

COD. PV8..		L. Mm
01		203
02		201
05		218
21		132

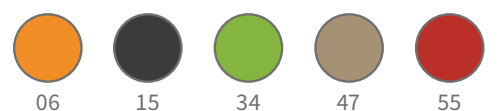

Baltic Abi

Inox 18/10 - St. Steel - 2,5 mm
Cod. CB6S..



COD. CB6S..

L. Mm



195



195



216



134

Personalizzazioni laser

Laser customization
 Personnalisation laser
 Laserpersonalisierung
 Personalización láser

**Punzonatura Laser**

Laser punching
 Poinçonnage laser
 Laser-Lochen
 Punzonado laser

**Punzonatura Meccanica**

Mechanical punching
 Poinçonnage mécanique
 Mechanish-Lochen
 Punzonado mecánico

Ordini minimi 6.000 pezzi per articolo
6.000 pcs/item minimum orders
Commandes minimales de 6.000 pcs par article
Bestellungen von 6.000/Stücke mindestens
Pedidos mínimos de 6.000 pzs por artículo

**Punzonatura Pantografo**

Pantograph punching
 Poinçonnage par pantographe
 Gravierung
 Punzonado con pantógrafo

**Doratura**

Gold-plating
 Dorure
 Vergoldung
 Dorado





PVD

La tecnica PVD (Physical Vapour Deposition) permette di depositare un film metallico di alto spessore con caratteristiche sorprendenti dal punto di vista decorativo e tecnico. Questo procedimento rende il prodotto trattato durevole nel tempo e conferisce elevata durezza superficiale. L'articolo diventa resistente ai solventi, agli acidi e a vari prodotti usati in cucina, mantenendo intatte le proprie caratteristiche chimico/fisiche. E' un trattamento assolutamente biocompatibile, anallergico ed idoneo al contatto con il cibo.

Polvere di Luna

La finitura Polvere di Luna rende l'aspetto delle posate satinato e delicatamente brillante: una superficie levigata con chiaroscuri. Piacevoli e vellutate al tatto, trasmettono una morbidezza ed un calore inconsueto per oggetti di acciaio. Un rivestimento sobrio ed inusuale per posate contemporanee.

Vintage

L'opacità, i graffi ed i segni volutamente prodotti sulla superficie delle posate con finitura Vintage danno la sensazione di oggetti vissuti ed utilizzati a lungo, di grandi cucine profumate, calde e piene di vapore, di convivialità di altri tempi, di sapori antichi. Evocano immagini di ambienti tradizionali, rustici e senza pretese di modernità.

FINITURE SPECIALI • SPECIAL FINISH

PVD

The PVD (Physical Vapour Deposition) technique allows to deposit a high-thickness metal film with remarkable characteristics from the decorative and technical point of view. Such process makes the product treated durable in time and gives high surface hardness. The item turns resistant to solvents, acids and to various products used in the kitchen, keeping its chemical/physical characteristics unchanged. It is a thoroughly biocompatible, anallergic treatment and suitable for food contact.

Polvere di Luna

The Polvere di Luna finish makes cutlery surface look satin-like and delicately brilliant: a smooth surface with contrasting shades. Pleasant and velvety to the touch, the cutlery so treated convey a softness and warmth unusual for steel objects. A sober and unusual coating for contemporary cutlery.

Vintage

Opacity, scratches and marks intentionally made on the surface of the cutlery with a finish give the effect of objects that have been used for a long time, of a large, warm and steamy kitchen filled with aromas, of the friendly gatherings of old good times and ancient flavours. They evoke images of traditional, simple environments with no intention to be modern.

PVD

PVD

Cod. ...41 Oro - Gold

Cod. ...40 Rame - Copper

Cod. ...74 Total Black - Total Black

Cod. ...42 Gun Metal - Gun Metal



Finitura disponibile per tutti i modelli

Finish available for all models

Non disponibile per posate a manico cavo

Not available for hollow-handle cutlery

Minimo di ordine 500 pz assortiti

500 assorted pcs minimum order

PVD oro
PVD Gold

Cod. ...41



PVD rame
PVD Copper

Cod. ...40

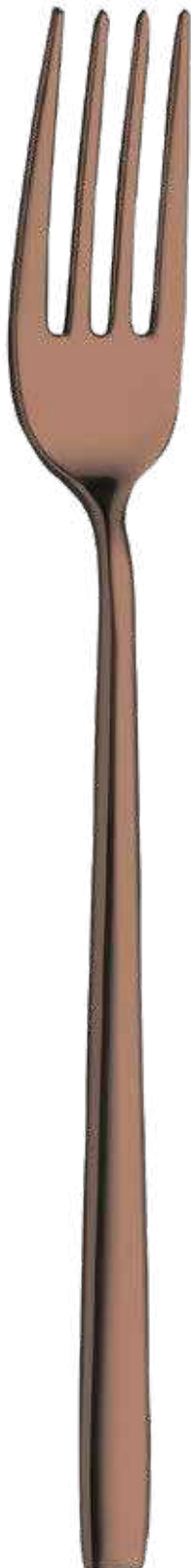

PVD Total Black
PVD Total Black

Cod. ...74



PVD Gun Metal
PVD Gun Metal

Cod. ...42



Polvere di Luna

Moon Dust
Cod. ...32



Finitura disponibile per tutti i modelli

Finish available for all models

Non disponibile per posate a manico cavo

Not available for hollow-handle cutlery

Minimo di ordine 500 pz assortiti

500 assorted pcs minimum order

Polvere di Luna PVD oro
Moon Dust PVD Gold

Cod. ...35



Polvere di Luna PVD rame
Moon Dust PVD Copper

Cod. ...53



Polvere di Luna PVD total black **Polvere di Luna PVD Gun Metal**
Moon Dust PVD Total Black Moon Dust PVD Gun Metal

Cod. ...75



Cod. ...39



Vintage

Vintage
Cod. ...51



Finitura disponibile per tutti i modelli

Finish available for all models

Non disponibile per posate a manico cavo

Not available for hollow-handle cutlery

Minimo di ordine 500 pz assortiti

500 assorted pcs minimum order

Vintage PVD oro
Vintage PVD Gold

Cod. ...57



Vintage PVD rame
Vintage PVD Copper

Cod. ...56



Vintage PVD Total Black
Vintage PVD Total Black

Cod. ...76



Vintage PVD Gun Metal
Vintage PVD Gun Metal

Cod. ...58



Scotch-Brite

Inox Scotch Brite
Cod. ...73



Finitura disponibile per tutti i modelli

Finish available for all models

Non disponibile per posate in PVD

Not available in PVD cutlery

Minimo di ordine 500 pz assortiti

500 assorted pcs minimum order







ACCESSORI • ACCESSORIES



Cucchiaino cereali

Cereal spoon
Cuillère à céréales
Cerealienlöffel
Cuchara de cereales

Inox 18/10 - St. Steel

	Mm	In
908 05 00 006	185	7,1/4

**Cucchiaino tè/moka**

Tea spoon
Cuillère à moka
Tee-/Mokalöffel
Cuchara de moka

Inox 18/10 - St. Steel

	Mm	In
908 05 00 003	120	4,3/4

**Paletta miscelatore**

Coffee stirrer
Agitateur à café
Kaffee-Rührer
Paleta café

Inox 18/10 - St. Steel

	Mm	In
908 05 00 005	100	4

**Cucchiaino spatolina**

Spatula spoon
Cuillère spatule
Spatel - Spatenlöffel
Cuchinilla spatula

Inox 18/10 - St. Steel

	Mm	In
908 05 00 002	149	6

**Cucchiaino yogurt/cioccolato/marmellata**

Yogurt / chocolate / jam spoon
Cuillère à yaourt / chocolat / confiture
Joghurt / Schokoladen / Marmeladenlöffel
Cuchara yogurt / chocolate / mermelada

Inox 18/10 - St. Steel

	Mm	In
908 05 00 001	121	4,3/4

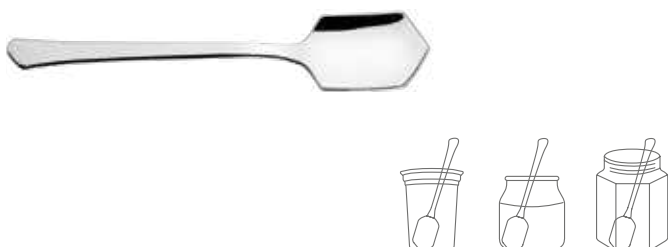

Cucchiaio moka appetizer con foro Linea

Linea moka spoon appetizer with hole
 Cuillère à moka de mise en bouche avec trou Linea
 Appetizer Mokalöffel mit Loch Linea
 Cuchara moka aperitivo con agujero Linea

Inox 18/10 - St. Steel

	Mm	In
CF7P 22F	106	4,1/8

**Cucchiaio caffè' appetizer Linea**

Linea tea spoon appetizer
 Cuillère à thé de mise en bouche Linea
 Appetizer Kaffee/Teelöffel Linea
 Cuchara café aperitivo Linea

Inox 18/10 - St. Steel

	Mm	In
CF7P 21	122	4,3/4

**Forchetta 2 punte appetizer Linea**

Linea fork appetizer, two-prong
 Fourchette de mise en bouche à deux dents Linea
 Appetizer Zweizinkengabel Linea
 Tenedor aperitivo dos puntas Linea

Inox 18/10 - St. Steel

	Mm	In
CF7P 63	105	4,1/8

**Cucchiaio moka appetizer Linea**

Linea moka spoon appetizer
 Cuillère à moka de mise en bouche Linea
 Appetizer Mokalöffel Linea
 Cuchara moka aperitivo Linea

Inox 18/10 - St. Steel

	Mm	In
CF7P 22	106	4,1/8

**Cucchiaio bibita appetizer Linea**

Linea cocktail spoon
 Cuillère à mazagan Linea
 Cocktailöffel Linea
 Cuchara refresco Linea

Inox 18/10 - St. Steel

	Mm	In
CF7P 35	210	8,1/4

**Cucchiaino moka con decoro fiore**

Moka spoon with flower decoration
 Cuillère à moka avec decoration fleure
 Mokalöffel mit beÜhmendekor
 Cucharita moka con decoración flor

Inox 18/10 - St. Steel

	mm	in
CDE 22F	103	4

**Cucchiaino moka con decoro rombo**

Moka spoon with rhombus decoration
 Cuillère à moka avec decoration losange
 Mokalöffel mit karodekor
 Cucharita moka con decoración rombo

Inox 18/10 - St. Steel

	Mm	In
CDE 22S	103	4

**Cucchiaino moka con decoro stella**

Moka spoon with star decoration
 Cuillère à moka avec decoration étoile
 Mokalöffel mit sterndekor
 Cucharita moka con decoración estrella

Inox 18/10 - St. Steel

	mm	in
CDE 22Q	103	4



Cucchiaino caffè Svezia

Svezia coffee spoon
 Cuillère à café Svezia
 Kaffee/Teelöffel Svezia
 Cuchara café Svezia

Inox 18/10 - St. Steel

	Mm	In
CSV 21	140	5,1/2

**Cucchiaino moka Svezia**

Svezia moka spoon
 Cuillère à moka Svezia
 Mokalöffel Svezia
 Cuchara moka Svezia

Inox 18/10 - St. Steel

	Mm	In
CSV 22	105	4,1/8

**Cucchiaino bibita Svezia**

Svezia cocktail spoon
 Cuillère à cocktail Svezia
 Cocktaillöffel Svezia
 Cuchara refresco Svezia

Acciaio Inox - St. Steel

	Mm	In
CSV 35	204	8

**Forchetta dolce Svezia**

Svezia cake fork
 Fourchette à gâteau Svezia
 Kuchengabel Svezia
 Tenedor lunch Svezia

Acciaio Inox - St. Steel

	Mm	In
CSV 38	145	5,3/4

**Cucchiaino gelato Svezia**

Svezia ice cream spoon
 Cuillère à glace Svezia
 Eislöffel Svezia
 Cuchara helado Svezia

Acciaio Inox - St. Steel

	Mm	In
CSV 37	131	5,1/8



Cucchiaino moka Riflesso

Riflesso moka spoon
 Cuillère à moka Riflesso
 Mokalöffel Riflesso
 Cuchara moka Riflesso

Inox 18/10 - St. Steel

	Mm	In
C33P 22	108	4,3/8

**Cucchiaino caffè Riflesso**

Riflesso coffee spoon
 Cuillère à café Riflesso
 Kaffee/Teelöffel Riflesso
 Cuchara café Riflesso

Inox 18/10 - St. Steel

	Mm	In
C33P 21	130	5,7/8

**Paletta gelato Riflesso**

Riflesso ice cream spoon
 Cuillère à glace Riflesso
 Eislöffel Riflesso
 Cuchara helado Riflesso

Inox 18/10 - St. Steel

	Mm	In
C33P 37	130	5,1/8

**Cucchiaino bibita Riflesso**

Riflesso cocktail spoon
 Cuillère à cocktail Riflesso
 Cocktaillöffel Riflesso
 Cuchara refresco Riflesso

Inox 18/10 - St. Steel

	Mm	In
C33P 35	201	7,7/8

**Cucchiaino caffè con piega Riflesso**

Riflesso s-shaped tea spoon
 Cuillère à thé pliée
 Riflesso - Gebogener Teelöffel Riflesso
 Cucharita café plegada Riflesso

Inox 18/10 - St. Steel

	Mm	In
C33P 392	115	4,1/2

**Cucchiaino bibita con piega Riflesso**

Riflesso s-shaped cocktail spoon
 Cuillère à mazagran pliée Riflesso
 Gebogener Cocktaillöffel Riflesso
 Cuchara refresco plegada Riflesso

Inox 18/10 - St. Steel

	Mm	In
C33P 394	185	7,1/4

**Forchettina dolce Riflesso**

Riflesso cake fork
 Fourchette à gâteau Riflesso
 Kuchengabel Riflesso
 Tenedor lunch Riflesso

Inox 18/10 - St. Steel

	Mm	In
C33P 38	144	5,3/4

**Forchettina 2 punte Riflesso**

Riflesso two-prong fork
 Fourchette à deux dents Riflesso
 Zweizinkengabel Riflesso
 Tenedor dos puntas Riflesso

Inox 18/10 - St. Steel

	Mm	In
C33P 63	144	5,3/4



Cucchiaino caffè bar

Bar coffee spoon
Cuillère à café bar
Kaffee/Teelöffel Bar
Cuchara café bar

Acciaio Inox - St. Steel

	Mm	In
903 06 81 020	133	5,1/8

**Cucchiaino moka 903**

903 Moka spoon
Cuillère à moka 903
Mokalöffel 903
Cuchara moka 903

Acciaio Inox - St. Steel

	Mm	In
903 06 81 024	111	4,3/8

**Cucchiaio fragola e confetti Milord**

Milord sweet spoon
Cuillère à sucreries Milord
Erdbeer- und Konfektlöffel Milord
Cuchara para dulces Milord

Inox 18/10 - St. Steel

	Mm	In
C14 36	170	6,5/8

**Cucchiaio fragola e confetti Imperial**

Imperial sweet spoon
Cuillère à sucreries Imperial
Erdbeer- und Konfektlöffel Imperial
Cuchara para dulces Imperial

Inox 18/10 - St. Steel

	Mm	In
C04 36	170	6,5/8

**Cucchiaio olive con fori**

Olive slotted spoon
Cuillère de mise en bouche olives perforée
Gelochter Oliven Löffel
Cuchara aceitunas perforada

Inox 18/10 - St. Steel

	Mm	In
903 05 81 AOF	225	8,7/8

**Cucchiaio olive**

Olive spoon
Cuillère de mise en bouche olives
Oliven Löffel
Cuchara aceitunas

Inox 18/10 - St. Steel

	Mm	In
903 05 81 AOL	225	8,7/8



Cucchiaio multiuso Matisse grande

Matisse slotted spoon large
 Cuillère à servir perforée Matisse grande
 Großer Universallöffel Matisse
 Cuchara para servir perforada Matisse grande

Inox 18/10 - St. Steel

	Mm	In
CF1 162	205	8,1/8

**Cucchiaio ghiaccio Matisse grande**

Matisse slotted long ice spoon
 Cuillère à glaçons perforée Matisse grande
 Großer Eiswürfelloffel Matisse
 Cucharón hielo perforado Matisse grande

Inox 18/10 - St. Steel

	Mm	In
CF1 253	205	8,1/8

**Cucchiaio multiuso Matisse piccolo**

Matisse slotted spoon
 Cuillère à servir perforée Matisse
 Kleiner Universallöffel Matisse
 Cuchara para servir perforada Matisse

Inox 18/10 - St. Steel

	Mm	In
CF1 161	170	6,5/8

**Cucchiaio ghiaccio Matisse piccolo**

Matisse slotted ice spoon
 Cuillère à glaçons perforée Matisse
 Kleiner Eiswürfelloffel Matisse
 Cuchara hielo perforada Matisse

Inox 18/10 - St. Steel

	Mm	In
CF1 251	170	6,5/8

**Cucchiaio multiuso Pop**

Pop slotted spoon
 Cuillère à servir perforée Pop
 Universallöffel Pop
 Cuchara para servir perforada Pop

Inox 18/10 - St. Steel

	Mm	In
CD4 162	202	7,8/8

**Cucchiaio ghiaccio Pop**

Pop slotted ice spoon
 Cuillère à glaçons perforée Pop
 Eiswürfelloffel Pop
 Cucharón hielo perforado Pop

Inox 18/10 - St. Steel

	Mm	In
CD4 253	202	7,8/8



Abert presenta Double, il nuovo utensile per... l'assaggio!

Innovativo: grazie alla sua forma metà cucchiaio e metà forchetta è l'unico strumento in grado di permettere assaggi di cibi liquidi e solidi.

Irrrinunciabile per gli chef, che possono finalmente sperimentare tutte le loro preparazioni con un solo oggetto nel taschino.

Ingegnoso e pratico per assaporare i cibi in occasione di degustazioni, aperitivi o buffet.

Abert presents Double, the new tool for... tasting!

Innovative: thanks to its shape half spoon and half fork, it is an instrument able to allow tastes of liquid and solid foods.

Essential for chefs, who can at last experiment all their preparations with just one object in their small pocket.

Ingenious and practical in order to savour foods at tastings, happy hours or buffets.

Double

Double
Double
Doppel
Double

Inox 18/10 - St. Steel

	Mm	In
903 05 81 DFS	165	6,1/2

**Appetizer Matisse con riccio**

Curled appetizer
Cuillère de mise en bouche en boucle
Appetizerlöffel
Aperitivo con nudo - cuchara

Inox 18/10 - St. Steel

		Mm	In
CF1 CR	SPOON	141	5,1/2
CF1 FR	FORK	136	5,3/8

**Appetizer Matisse con piega - cucchiaio**

Bended appetizer spoon
Cuillère de mise en bouche pliée
Appetizerlöffel
Aperitivo plegada - cuchara

Inox 18/10 - St. Steel

		Mm	In
CF1 CP	SPOON	142	5,1/2
CF1 FP	FORK	138	5,3/8



**Forchettina appetizer segnaposto**

Place-card appetizer fork
Fourchette de mise en bouche marque-place
Tischkarte Appetizer Gabel
Tenedor aperitivo etiqueta

Inox 18/10 - St. Steel

	H Mm	H In
903 05 81 APF	97	3,7/8

Tapas Matisse

Matisse Tapas
Cuillère Tapas Matisse
Tapas Matisse
Tapas Matisse

Inox 18/10 - St. Steel

	Mm	In
CF1 TA	170	6,3/4

**Cucchiaio appetizer tondo**

Appetizer curved spoon
Cuillère de mise en bouche ronde pliée
Appetizer - rund gebogener Löffel
Cuchara aperitivo redonda plegada

Inox 18/10 - St. Steel

	Mm	In
903 05 81 APC	140	5,1/2

**Appetizer Brigitte con piega**

Bended appetizer spoon Brigitte
Mise en bouche pliée Brigitte
Appetizerlöffel Brigitte
Aperitivo plegada Brigitte

Inox 18/10 - St. Steel

	Mm	In
C68 CP	142	5,1/2 SPOON
C68 FP	142	5,1/2 FORK

**Mini appetizer Ego**

Ego mini appetizer
Mini mise en bouche Ego
Mini Appetizer Ego
Mini aperitivo Ego

Inox 18/10 - St. Steel

	Mm	In
CD3 38M	115	4,1/2 FORK
CD3 22	115	4,1/2 SPOON



Coltello carne Modern seghettato

Modern steak knife
 Couteau à bifteck Modern
 Modern Steakmesser
 Cuchillo carne Modern

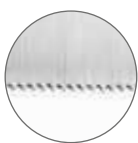
**Acciaio Inox / ABS - St. Steel / ABS**

	Mm	In
903 06 86 A	227	9

**Coltello carne Modern filo rasoio**

Modern steak knife
 Couteau à bifteck Modern
 Modern Steakmesser
 Cuchillo carne Modern

**Acciaio Inox / ABS - St. Steel / ABS**

	Mm	In
903 06 86 B	227	9

**Coltello Angus seghettato**

Angus steak knife
 Couteau à bifteck Angus
 Angus Steakmesser
 Cuchillo carne Angus

**Acciaio Inox / POM - St. Steel / POM**

	Mm	In
CAN 55	229	9

**Coltello Angus filo rasoio**

Angus steak knife
 Couteau à bifteck Angus
 Angus Steakmesser
 Cuchillo carne Angus

**Acciaio Inox / POM - St. Steel / POM**

	Mm	In
CAN 55R	229	9

**Coltello carne lama 12 Cm**

Steak knife, blade 12Cm
 Couteau à bifteck 12Cm
 12Cm Steakmesser
 Cuchillo carne 12Cm

Acciaio Inox / PP - St. Steel / PP

	Mm	In
AVARI 180	228	9

**Coltello carne Kansas**

Kansas steak knife
 Couteau à bifteck Kansas
 Kansas Steakmesser
 Cuchillo carne Kansas

Acciaio Inox / POM - St. Steel / POM

	Mm	In
CKA 55	218	8,5/8



Coltello carne Kobe

Kobe steak knife
 Couteau à bifteck Kobe
 Kobe Steakmesser
 Cuchillo carne Kobe



Acciaio Inox / Legno - St. Steel / Wood

	Mm	In
CKO 55	244	9,5/8



Coltello carne Kobe

Kobe steak knife
 Couteau à bifteck Kobe
 Kobe Steakmesser
 Cuchillo carne Kobe



Acciaio Inox / Legno - St. Steel / Wood

	Mm	In
CKO 55R	244	9,5/8



Coltello carne Fuego

Fuego steak knife
 Couteau à bifteck Fuego
 Fuego Steakmesser
 Cuchillo carne Fuego



Acciaio Inox / ABS - St. Steel / ABS

	Mm	In
CFU 55	232	9



Coltello carne Fuego

Fuego steak knife
 Couteau à bifteck Fuego
 Fuego Steakmesser
 Cuchillo carne Fuego



Acciaio Inox / ABS - St. Steel / ABS

	Mm	In
CFU 55R	232	9



Coltello carne Boty

Boty steak knife
 Couteau à bifteck Boty
 Boty Fleischmesser
 Cuchillo carne Boty

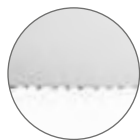

Acciaio Inox - St. Steel

	Mm	In
CD2 55	235	9,1/4



Coltello carne Boty

Boty steak knife
 Couteau à bifteck Boty
 Boty Fleischmesser
 Cuchillo carne Boty



Acciaio Inox - St. Steel

	Mm	In
CD2 55R	235	9,1/4



Coltello fiorentina

Fiorentina steak knife
 Couteau à bifteck Fiorentina
 Fiorentina Steakmesser
 Cuchillo carne Fiorentina

Acciaio Inox - St. Steel

	Mm	In
CFI 55	230	9

**Forchetta fiorentina**

Fiorentina steak fork
 Fourchette à bifteck Fiorentina
 Fiorentina Steakgabel
 Tenedor carne Fiorentina

Inox 18/10 - St. Steel

	Mm	In
CFI 02	204	8

**Coltello carne Pampero**

Pampero steak knife
 Couteau à bifteck Pampero
 Pampero Steakmesser
 Cuchillo carne Pampero

Acciaio Inox - St. Steel

	Mm	In
CPP 55	222	8,5/8

**Forchetta carne Pampa**

Pampa steak fork
 Fourchette à bifteck Pampa
 Pampa Steakgabel
 Tenedor carne Pampa

Inox 18/10 - St. Steel

	Mm	In
CPA 52	197	7,5/8

**Coltello carne Malaga**

Malaga steak knife
 Couteau à bifteck Malaga
 Malaga Fleischmesser
 Cuchillo carne Malaga

Acciaio Inox - St. Steel

	Mm	In
CMA 55	231	8,5/8

**Forchetta carne Altozano/Malaga**

Altozano steak fork
 Fourchette à bifteck Altozano
 Altozano Steakgabel
 Tenedor carne Altozano

Acciaio Inox - St. Steel

	Mm	In
CAL 52	205	8

**Coltello pizza Azzurra**

Azzurra pizza knife
 Couteau à pizza Azzurra
 Azzurra Pizzamesser
 Cuchillo pizza Azzurra

Acciaio Inox - St. Steel

	Mm	In
CZ 7134	225	8,7/8

**Forchetta pizza Azzurra**

Azzurra pizza fork
 Fourchette à pizza Azzurra
 Azzurra Pizzagabel
 Tenedor pizza Azzurra

Acciaio Inox - St. Steel

	Mm	In
CZ 752	200	7,7/8



Coltello pizza Modern acciaio

Modern pizza knife
 Couteau à pizza Modern
 Modern Pizzamesser
 Cuchillo pizza Modern

Acciaio Inox - St. Steel

	Mm	In
CPI 05P	205	8

**Forchetta pizza Modern acciaio**

Modern pizza fork
 Fourchette à pizza Modern
 Modern Pizzagabel
 Tenedor pizza Modern

Acciaio Inox - St. Steel

	Mm	In
CPI 02 CR	203	7,7/8

**Coltello carne America monoblocco**

America steak knife, solid handle
 Couteau à bifteck America monobloc
 Steakmesser America, monoblock
 Cuchillo carne America monobloque

Acciaio Inox - St. Steel

	Mm	In
C46 55	210	9

**Coltello carne Modern acciaio**

Modern steak knife
 Couteau à bifteck Modern
 Modern Steakmesser
 Cuchillo carne Modern

Acciaio Inox - St. Steel

	Mm	In
CPI 05	226	8,7/8

**Coltello pizza Palio**

Pizza knife Palio
 Couteau à pizza Palio
 Palio Pizzamesser
 Cuchillo pizza Palio

Acciaio Inox - St. Steel

	Mm	In
CC3 134	210	8,1/4

**Coltello carne Pampero / C**

Pampero steak knife
 Couteau à bifteck Pampero
 Pampero Steakmesser
 Cuchillo carne Pampero

Acciaio Inox - St. Steel

	Mm	In
CPP 55/C	222	8,5/8



Coltello carne Rost punta

Rost steak knife
 Couteau à viande Rost
 Fleischmesser Rost
 Cuchillo carne Rost

Acciaio Inox manico nero

AVARI 064B 06 pz.6
 AVARI 064B 12 pz.12

**Coltello carne Rost punta tonda**

Rost steak knife round point
 Couteau à viande Rost pointe ronde
 Fleischmesser Rost
 Cuchillo carne Rost con punta redonda

Acciaio Inox manico nero

AVARI 064T B06 pz.6
 AVARI 064T B12 pz.12

**Coltello pizza Rost**

Pizza knife Rost
 Couteau à pizza Rost
 Rost Pizzamesser
 Cuchillo pizza Rost

Acciaio Inox manico nero

AVARI 064P B06 pz.6
 AVARI 064P B12 pz.12

**Coltello carne Arlecchino punta**

Arlecchino steak knife
 Couteau à viande Arlecchino
 Fleischmesser Arlecchino
 Cuchillo carne Arlecchino

Acciaio Inox colori assortiti

	Mm	In	
● AVARI 047 47	211	8,1/4	pz.6
● AVARI 047 07	211	8,1/4	pz.6
○ AVARI 047 13	211	8,1/4	pz.6
● AVARI 047 34	211	8,1/4	pz.6
● AVARI 047 06	211	8,1/4	pz.6
○ AVARI 047 19	211	8,1/4	pz.6
● AVARI 047 14	211	8,1/4	pz.6

**Coltello carne Arlecchino punta tonda**

Arlecchino steak knife round point
 Couteau à viande Arlecchino pointe ronde
 Fleischmesser Arlecchino
 Cuchillo carne Arlecchino con punta redonda

Acciaio Inox colori assortiti

	Mm	In	
● AVARI 047T 47	211	8,1/4	pz.6
● AVARI 047T 07	211	8,1/4	pz.6
○ AVARI 047T 13	211	8,1/4	pz.6
● AVARI 047T 34	211	8,1/4	pz.6
● AVARI 047T 06	211	8,1/4	pz.6
○ AVARI 047T 19	211	8,1/4	pz.6
● AVARI 047T 14	211	8,1/4	pz.6



Pinza aragosta forgiata

Lobster cracker, forged
Pince à homard forgé
Langustezange - geschmieden
Pinzas langosta forjadas

Acciaio Inox - St. Steel

	Mm	In
305 05 91 658	210	8,1/4

**Stiletto aragosta**

Lobster pick
Fourchette à homard
Langustegabel
Tenedor langosta

Inox 18/10 - St. Steel

	Mm	In
903 05 84 659	202	7,7/8

**Forchettina ostriche**

Oyster fork
Fourchette à crustacés
Austerngabel
Tenedor ostras

Inox 18/10 - St. Steel

	Mm	In
CF1 64	156	6,1/8

**Stiletto ostriche/crostacei**

Oyster fork
Fourchette à crustacés
Krustengabel
Tenedor mariscos

Inox 18/10 - St. Steel

	Mm	In
CPA 64	227	8,7/8

**Forchettina 2 punte Matisse**

Matisse fork, two-prong
Fourchette à deux dents Matisse
Zweizinkengabel Matisse
Tenedor dos puntas Matisse

Inox 18/10 - St. Steel

	Mm	In
CF1 63	156	3,1/8

**Molla lumache**

Snail tongs
Pince à escargots
Schneckenzange
Pinzas caracoles

Acciaio Inox - St. Steel

	Mm	In
903 05 81 MLU	160	6,1/4



Coltello formaggi cremosi Regis Spalmy

Spalmy creamy cheese knife
 Couteau à fromages crèmeux Spalmy
 Schmelzkäsemesser Spalmy
 Cuchillo quesos cremosos Spalmy

Acciaio Inox - St. Steel

	Mm	In
903 05 84D	225	8,7/8

**Coltello paste molli Regis Tommy**

Tommy tender cheese knife
 Couteau à fromages à pâte molle Tommy
 Weichkäsemesser Tommy
 Cuchillo quesos pasta blanda Tommy

Acciaio Inox - St. Steel

	Mm	In
903 05 84A	218	8,5/8

**Coltello 2 punte Regis Emmy**

Emmy medium-hard cheese knife
 Couteau à fromages à pâte demi-ferme Emmy
 Milderkäsemesser Emmy
 Cuchillo quesos pasta semi-dura Emmy

Acciaio Inox - St. Steel

	Mm	In
903 05 84B	221	8,5/8

**Coltello formaggi di paste crude Regis Parmy**

Parmy hard cheese knife
 Couteau à fromages à pâte ferme Parmy
 Hartkäsemesser Parmy
 Cuchillo quesos pasta dura Parmy

Acciaio Inox - St. Steel

	Mm	In
903 05 84C	199	7,7/8

**Coltello formaggelle Regis Formy**

Formy formaggelle soft cheese knife
 Couteau à fromages à pâte molle formaggelle Formy
 Frischkäsemesser Formy
 Cuchillo quesos pasta blanda formaggelle Formy

Acciaio Inox - St. Steel

	Mm	In
903 05 84E	273	10,5/8

**Coltello agrumi Regis**

Regis citrus fruit knife
 Couteau à agrumes Regis
 Orangenmesser Regis
 Cuchillo cítricos Regis

Acciaio Inox - St. Steel

	Mm	In
903 05 84 269	220	8,5/8

**Affettaformaggio Regis 18/10**

Regis cheese slicer
 Pelle coupe-fromage Regis
 Käsehobel Regis
 Pala corta queso Regis

Acciaio Inox - St. Steel

	Mm	In
903 05 84 135	190	7,1/2



Schiaccianoci forgiato

Nut cracker - forged
Casse noix forgé
Nußknacker geschmieden
Cascanueces forjado

Inox 18/10 - St. Steel

	Mm	In
AVARI 117	150	6

**Schiaccianoci**

Nut cracker
Casse noix
Nußknacker
Cascanueces

Inox 18/10 - St. Steel

	Mm	In
903 05 84 163	220	8,5/8

**Paletta raccoglibriciole**

Crumb sweeper
Pelle ramasse-miettes
Krümelsammler
Pala recogemigas

Inox 18/10 - St. Steel

	Mm	In
903 05 91 939	160	6,1/4

**Easy Spaghetti e pasta 3 in 1****Dosaspaghetti - Assaggiapaghetti - Assaggiapasta**

Spaghetti doser - Spaghetti taster - Pasta taster
Doseur spaghetti - Goute-spaghetti - Goute-pâtes
Spaghetti-Maß - Spaghettitester - Nudel-Tester
Dosificador de espagueti - Prueba espagueti - Prueba pasta

Inox 18/10 - St. Steel

	Mm	In
903 05 81 ESP	225	8,7/8



Forchettone spaghetti

Spaghetti serving fork
Fourchette à servir spaghetti
Spaghettigabel
Tenedor servir spaghetti

Inox 18/10 - St. Steel

	Mm	In
903 05 91 792	278	11

**Mestolo punch**

Punch ladle
Louche à punch
Punch Schöpflöffel
Cazo punch Svezia

Inox 18/10 - St. Steel

	Mm	In
CSV 66	280	11

**Cucchiaio insalata con piega Pivot**

Pivot curved salad spoon
Grosse cuillère à salade pliée Pivot
Gebogene Salatlöffel Pivot
Cuchara ensalada plegada Pivot

Inox 18/10 - St. Steel

	Mm	In
CD8 28	255	10,1/8

**Forchetta insalata con piega Pivot**

Pivot curved salad fork
Grosse fourchette à salade pliée Pivot
Gebogene Salatgabel Pivot
Tenedor ensalada plegado Pivot

Inox 18/10 - St. Steel

	Mm	In
CD8 29	255	10,1/8

**Cucchiaio forato multiuso con piega Pivot**

Pivot curved slotted spoon
Cuillère perforée à servir pliée Pivot
Gebogener, gelochter Universallöffel Pivot
Cuchara perforada para servir plegada Pivot

Inox 18/10 - St. Steel

	Mm	In
CD8 162	255	10,1/8

**Cucchiaio ghiaccio multiuso con piega Pivot**

Pivot slotted long ice spoon
Cuillère à glaçons / salade pliée Pivot
Gebogener Universaleislöffel Pivot
Cucharón hielo / ensalada plegado Pivot

Inox 18/10 - St. Steel

	Mm	In
CD8 253	255	10,1/8



Mestolo con piega

S-shaped soup ladle
 Louche pli e
 Gebogener Sch opfl offel
 Cazo sopa plegado

Inox 18/10 - St. Steel

	Mm	In
C00 25CP	275	10,7/8

**Cucchiaio macedonia con piega**

S-shaped fruit salad spoon
 Cuill re   salade de fruits pli e
 Gebogener Obstsalatl offel
 Cuchara ensalada de frutas plegada

Inox 18/10 - St. Steel

	Mm	In
C00 27CP	215	8,1/2

**Forchetta multiuso con piega**

S-shaped fork
 Fourchette pli e
 Gebogene Universalgabel
 Tenedor plegado

Inox 18/10 - St. Steel

	Mm	In
C00 26CP	215	8,1/2

**Cucchiaio servi miele con piega**

S-shaped honey serving spoon
 Cuill re   miel pli e
 Gebogener Honigl offel
 Cuchara para miel plegada

Inox 18/10 - St. Steel

	Mm	In
C89 390	140	5,1/2



Cucchiaione riso professionale

Professional rice-serving spoon
Cuillère à riz professionnelle
Reislöffel
Cucharón arroz profesional

Inox 18/10 - St. Steel

	Mm	In
903 05 91 795	256	10

**Pala fritto professionale**

Professional frying palette
Pelle à friture professionnelle
Schaufel
Pala frito profesiona

Inox 18/10 - St. Steel

	Mm	In
903 05 91 062	295	11,5/8

**Cucchiaione forato professionale**

Professional slotted serving spoon
Cuillère perforée professionnelle
Gelochter Löffel
Cucharón servir perforado profesional

Inox 18/10 - St. Steel

	Mm	In
903 05 91 796	290	11,1/2

**Cucchiaione ghiaccio professionale**

Professional ice-serving spoon
Cuillère à glaçons professionnelle
Eislöffel
Cucharón hielo profesional

Inox 18/10 - St. Steel

	Mm	In
903 05 91 063	290	11,1/2

**Cucchiaione insalata professionale**

Professional salad-serving spoon
Cuillère à salade professionnelle
Salatlöffel
Cucharón ensalada profesional

Inox 18/10 - St. Steel

	Mm	In
903 05 91 066	285	11,1/4

**Cucchiaione servire professionale**

Professional serving spoon
Cuillère à servir professionnelle
Löffel
Cucharón servir profesional

Inox 18/10 - St. Steel

	Mm	In
903 05 91 793	290	11,1/2

**Cucchiaino riso forato professionale**

Professional rice-serving spoon
Cuillère à riz professionnelle
Reislöffel
Cucharón arroz profesional

Inox 18/10 - St. Steel

	Mm	In
903 05 91 795 F	256	10

**Mestolo professionale**

Professional ladle
Louche professionnelle
Professionelle Schöpfkelle
Cazo profesional

Inox 18/10 - St. Steel

	Mm	In
903 05 91 025	288	11,3/4



Forchettone servire professionale

Professional serving fork
Fourchette à servir professionnelle
Gabel
Tenedor servir profesional

Inox 18/10 - St. Steel

	Mm	In
903 05 91 794	294	11,5/8

**Forchettone arrosto professionale**

Professional carving fork
Grande fourchette rôti professionnelle
Fleischgabel
Tenedor asado profesional

Inox 18/10 - St. Steel

	Mm	In
903 05 91 064	285	11,1/4

**Coltello torta seghettato professionale**

Professional serrated-edge cake knife
Couteau à gâteau professionnel lame dentelée
Kuchmesser
Cuchillo pastel profesional dentado

Inox 18/10 - St. Steel

	Mm	In	
903 05 91 788	297	11,3/4	seghettato / serrated

**Coltello torta professionale**

Professional cake knife
Couteau à gâteau professionnel
Tortennmesser
Cuchillo pastel profesional

Inox 18/10 - St. Steel

	Mm	In
903 05 91 798	297	11,3/4

**Pala torta seghettata professionale**

Professional serrated-edge cake server
Pelle à gâteau dentelée professionnelle
Tortenschaufel
Pala pastel profesional dentada

Inox 18/10 - St. Steel

	Mm	In
903 05 91 786	297	11,3/4

**Pala torta professionale**

Professional cake server
Pelle à gâteau professionnelle
Tortenschaufel
Pala pastel profesional

Inox 18/10 - St. Steel

	Mm	In
903 05 91 799	297	11,3/4

**Spatola crepes professionale**

Professional crepes server
Spatule à crêpes professionnelle
Crepesschaufel
Pala crepes profesional

Inox 18/10 - St. Steel

	Mm	In
903 05 91 065	292	11,1/2

**Pala gratin professionale**

Professional gratin server
Pelle à gratin professionnelle
Backschaufel
Pala lasaña profesional

Inox 18/10 - St. Steel

	Mm	In	
903 05 91 787	268	10,5/8	seghettata / serrated
903 05 91 797	268	10,5/8	



Molla insalata o vegetali

Salad-vegetable tongs
Pince à légumes
Gemüsezange
Pinza para ensalada

Acciaio Inox - St. Steel

	Mm	In
CI 18601	195	7,5/8

**Molla servire**

Serving tongs
Pince à servir
Servierzange
Pinza de servicio

Acciaio Inox - St. Steel

	Mm	In
CI 18602	195	7,5/8

**Molla asparagi**

Asparagus tongs
Pince à asperges
Spargelzange
Pinza para espàrragos

Acciaio Inox - St. Steel

	Mm	In
CI 18603	195	7,5/8

**Molla pasta**

Pasta tongs
Pince pasta
Pastazange
Pinza pasta

Acciaio Inox - St. Steel

	Mm	In
CI 18604	195	7,5/8

**Molla dolci / toast**

Cake tongs
Pince à pâtisserie
Gebäckzange
Pinza para pasteles

Acciaio Inox - St. Steel

	Mm	In
CI 18703	180	7



Molla per pane Cosmos

Cosmos bread tongs
Pince à pain Cosmos
Brotzange Cosmos
Pinzas pan Cosmos

Acciaio inossidabile - St. Steel

	Mm	In
● V53 05 81 MPA 15	225	8,7/8
● V53 05 81 MPA 34	225	8,7/8
● V53 05 81 MPA 41	225	8,7/8
● V53 05 81 MPA 43	225	8,7/8
● V53 05 81 MPA 47	225	8,7/8

**Molla per spaghetti Cosmos**

Cosmos spaghetti tongs
Pince à spaghetti Cosmos
Spaghettizzange Cosmos
Pinzas spaghetti Cosmos

Acciaio inossidabile - St. Steel

	Mm	In
● V53 05 81 MSP 15	230	9,1/8
● V53 05 81 MSP 34	230	9,1/8
● V53 05 81 MSP 41	230	9,1/8
● V53 05 81 MSP 43	230	9,1/8
● V53 05 81 MSP 47	230	9,1/8

**Molla per arrosto Cosmos**

Cosmos roast tongs
Pince à rôti Cosmos
Braten/Fleischzange Cosmos
Pinzas asado Cosmos

Acciaio inossidabile - St. Steel

	Mm	In
● V53 05 81 MAR 15	220	8,5/8
● V53 05 81 MAR 34	220	8,5/8
● V53 05 81 MAR 41	220	8,5/8
● V53 05 81 MAR 43	220	8,5/8
● V53 05 81 MAR 47	220	8,5/8

**Molla per dolce Cosmos**

Cosmos cake tongs
Pince à gâteau Cosmos
Gebäckzange Cosmos
Pinzas postre Cosmos

Acciaio inossidabile - St. Steel

	Mm	In
● V53 05 81 MDO 15	220	8,5/8
● V53 05 81 MDO 34	220	8,5/8
● V53 05 81 MDO 41	220	8,5/8
● V53 05 81 MDO 43	220	8,5/8
● V53 05 81 MDO 47	220	8,5/8

**Molla per ghiaccio Cosmos**

Cosmos ice tongs
Pince à glace Cosmos
Eiszange Cosmos
Pinzas hielo Cosmos

Acciaio inossidabile - St. Steel

	Mm	In
● V53 05 81 MGH 15	214	8,3/8
● V53 05 81 MGH 34	214	8,3/8
● V53 05 81 MGH 41	214	8,3/8
● V53 05 81 MGH 43	214	8,3/8
● V53 05 81 MGH 47	214	8,3/8



Molla arrosto Modern

Roast tongs
Pince à rôti
Fleischzange
Pinzas asado

Acciaio Inox - St. Steel

	Mm	In
903 05 81 MAR	250	8,7/8

**Molla dolci Modern**

Cake tongs
Pince à gâteaux
Gebäckzange
Pinzas postre

Acciaio Inox - St. Steel

	Mm	In
903 05 81 MDO	250	8,7/8

**Molla ghiaccio Modern**

Ice tongs
Pince à glaçons
Eiszange
Pinzas hielo

Acciaio Inox - St. Steel

	Mm	In
903 05 81 MGH	200	7,7/8

**Molla spaghetti Modern**

Spaghetti tongs
Pince à spaghetti
Spaghettizange
Pinzas spaghetti

Acciaio Inox - St. Steel

	Mm	In
903 05 81 MSP	250	8,7/8



Molla insalata Long

Salad tongs
Pince à salade
Salatzange
Pinzas ensalada

Acciaio Inox - St. Steel

	Mm	In
903 05 81 MIN	270	10,5/8

**Molla pasta Long**

Pasta tongs
Pince à pâtes
Pastazange
Pinzas pasta

Acciaio Inox - St. Steel

	Mm	In
903 05 81 MPA	270	10,5/8

**Molla multiuso Long**

Multipurpose tongs
Pince à servir
Multipurposezange
Pinzas para servir

Acciaio Inox - St. Steel

	Mm	In
903 05 81 MMU	295	11,5/8

**Molla Universal Long**

Universal tongs
Pince Universal
Universalzange
Pinzas Universal

Acciaio Inox - St. Steel

	Mm	In
903 05 81 MUN	270	10,5/8







- BUFFET



Urban

Abert firma Urban, un supporto creativo per le preparazioni in sala, versatile, fantasioso e bello da vedere.

Base ideale per un buffet di finger food, impeccabile supporto da colazione grazie ai numerosi accessori correlati e perfetto allestimento emozionale per aperitivi e brunch.

Urban è facile da allestire e consente la veloce creazione di figure geometriche modulari sempre diverse, per posizionare ogni creazione culinaria secondo la propria fantasia.

Abert has designed Urban, a creative support for food preparation in the restaurants, versatile, multipurpose and nice to see.

Ideal base for a finger-food buffet, perfect lunch podium system thanks to the numerous accessories provided, and impressive set-up for the happy hour and the brunch.

Urban is easy to assemble and allows the fast creation of continuously different modular shapes, in order to place every food preparation according to everyone's imagination.

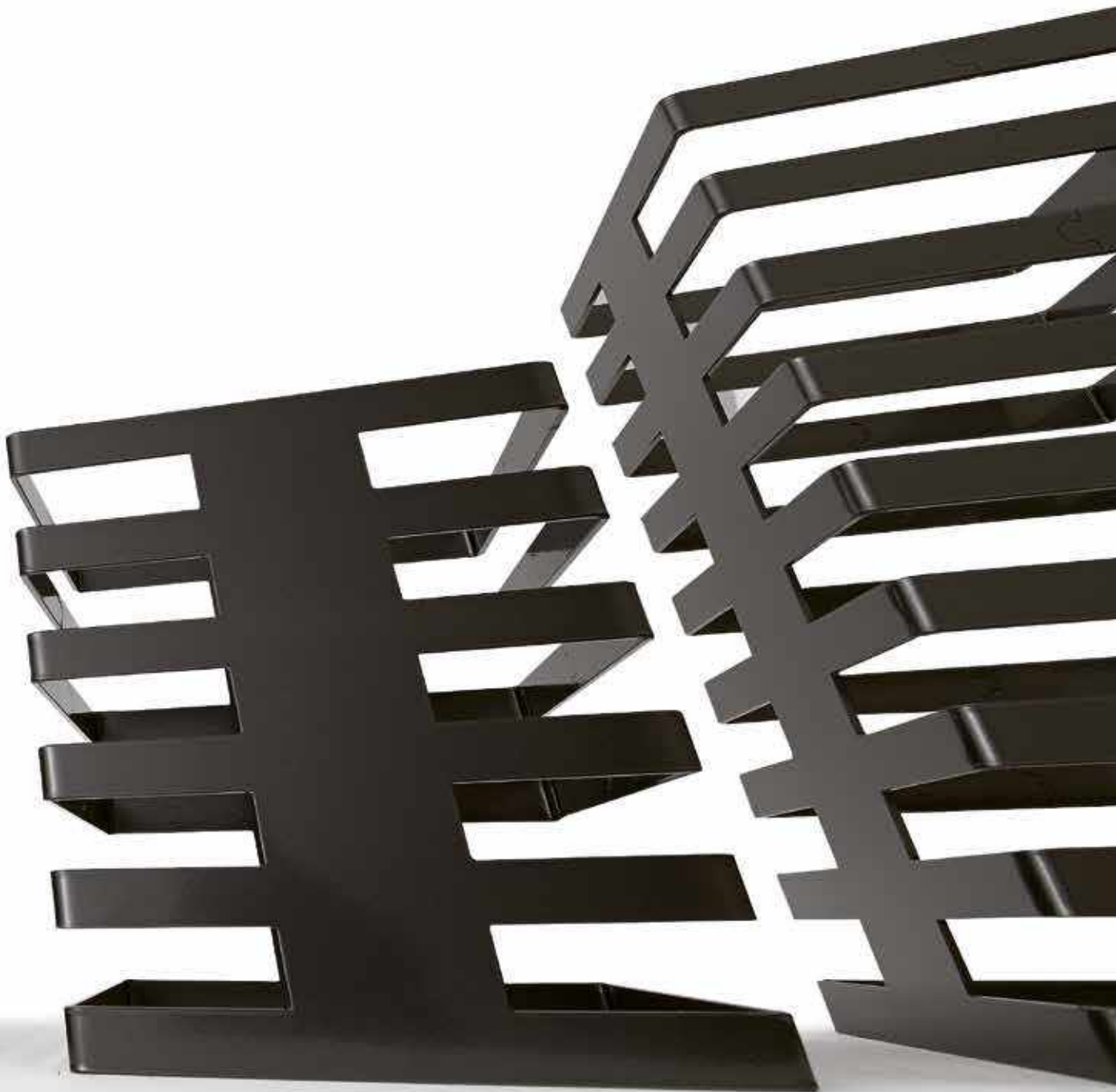

**SET 1**

Urban Tower
Tower Urban
Tower Urban
Urban Tower

V87 32 42 001	Cm	H Cm
	140x42	67
	In	H In
	55,1/8x16,1/2	26,3/8

**SET 4**

Urban Tower
Tower Urban
Tower Urban
Urban Tower

V87 32 42 004	Cm	H Cm
	260x42	67
	In	H In
	102,1/8x16,1/2	26,3/8





SET 3

Urban Tower
Tower Urban
Tower Urban
Urban Tower

V87 32 42 003

Cm	H Cm
150x145	67
In	H In
59,1/8x57,1/8	26,3/8

SET 2

Urban Tower
Tower Urban
Tower Urban
Urban Tower

V87 32 02 002

Cm	H Cm
140x42	43
In	H In
55,1/8x16,1/2	17



Tower

Tower
Tower
Tower
Tower

	Cm	H Cm	In	H In
V87 18 42 001	20x20	10	7,7/8x7,7/8	4
V87 18 42 002	20x20	22	7,7/8x7,7/8	8,5/8
V87 18 42 003	20x20	34	7,7/8x7,7/8	13,3/8
V87 18 42 004	20x20	58	7,7/8x7,7/8	22,7/8

**Modulo a croce**

Cross-shaped extension unit
Croix
Verbindungskreuz
Módulo con forma de cruz

	H Cm	In
V87 18 42 CRO	9,5	3,3/4

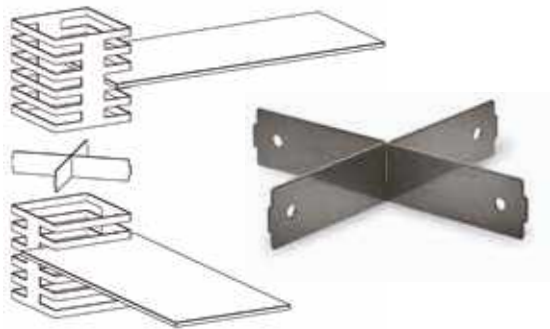
**Scala angolare 4 ripiani**

4-shelf corner ladder
Etagère angulaire 4 étages
Eck-Leiter (4 Stufen) Plexiglas
Escalera angular 4 estantes

	Cm	H Cm	In	H In
V87 12 42 SA2	40x40	10	15,3/4x15,3/4	4

**Coppa quadrata in plexiglass fumé**

Smoky plexiglass salad bowl, square
Bol plexiglass fumé carré
Salatschale Plexiglas viereckig Smoky
Ensaladera acrílica fumé cuadrada

	Cm	H Cm	In	H In
V87 12 42 C01	34x34	11	13,3/8x13,3/8	4,3/8
V87 12 42 C02	34x34	19	13,3/8x13,3/8	7,1/2

**Piatto quadrato plexiglass fumé**

Smoky plexiglass buffet plate, square
Plat plexiglass fumé carré
Buffetplatte Plexiglas viereckig Smoky
Plato acrílico fumé cuadrado

	Cm	In
V87 12 42 P01	30x30	11,3/4x11,3/4



Piano in vetro fumé

Smoky glass top
 Dessus en verre fumé
 Glasplatte Smoky
 Tablero de cristal fumé

	Cm	In
V87 08 42 Q01	30x30	11,3/4x11,3/4
V87 08 42 Q02	42x42	16,1/2x16,1/2
V87 08 42 R01	30x70	11,3/4x27,1/2
V87 08 42 R02	30x100	11,3/4x39,3/8
V87 08 42 R03	42x70	16,1/2x27,1/2
V87 08 42 R04	42x100	16,1/2x39,3/8

**Piano in ardesia**

Slate top
 Dessus en ardoise
 Schieferplatte
 Tablero de pizarra

	Cm	In
V87 09 42 Q01	30x30	11,3/4x11,3/4
V87 09 42 Q02	42x42	16,1/2x16,1/2
V87 09 42 R01	30x70	11,3/4x27,1/2
V87 09 42 R02	30x100	11,3/4x39,3/8
V87 09 42 R03	42x70	16,1/2x27,1/2
V87 09 42 R04	42x100	16,1/2x39,3/8

**Piano in mdf**

Mdf top
 Dessus en mdf
 Mdf Platte
 Tablero de mdf

	Cm	In
V87 04 42 Q01	30x30	11,3/4x11,3/4
V87 04 42 Q02	42x42	16,1/2x16,1/2
V87 04 42 R01	30x70	11,3/4x27,1/2
V87 04 42 R02	30x100	11,3/4x39,3/8
V87 04 42 R03	42x70	16,1/2x27,1/2
V87 04 42 R04	42x100	16,1/2x39,3/8

**Totem**

Totem
 Totem
 Totem
 Totem

	Cm	H Cm	In	H In
V87 18 42 T01	29x29	14	11,1/2x11,1/2	5,1/2
V87 18 42 T02	42x42	22	16,1/2x16,1/2	8,5/8



* Venduto senza ripiano / Sold without shelf

Scaldavivande da incasso con coperchio in acciaio Inox

Built-in chafing dish with St. Steel cover
Chafing dish encastrable avec couvercle en acier Inox
Chafing Dish zum Einbauen mit Edelstahl Deckel
Chafing dish para empotrar con tapa en acero Inox

	GN	Cm	H Cm
V87 18 52 002	1/1	60,5x40,5	39,5
		In	H In
		23,7/8x16	15,1/2

2 fornelli - 2 burners



Completo di due fornelli a combustibile solido
e predisposto per piastra elettrica.
Portavivande in acciaio incluso

With two solid fuel burners,
electric heating element available.
With Gastronorm food pan

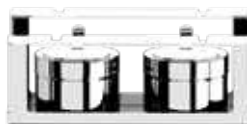

Scaldavivande da incasso con coperchio in acciaio Inox /vetro

Built-in chafing dish with St. Steel / glass cover
Chafing dish encastrable avec couvercle en acier Inox / verre
Chafing Dish zum Einbauen mit Edelstahl / Glass Deckel
Chafing dish para empotrar con tapa en acero Inox / vidrio

	GN	Cm	H Cm
V87 18 52 003	1/1	60,5x40,5	39,5
		In	H In
		23,7/8x16	15,1/2

2 fornelli - 2 burners

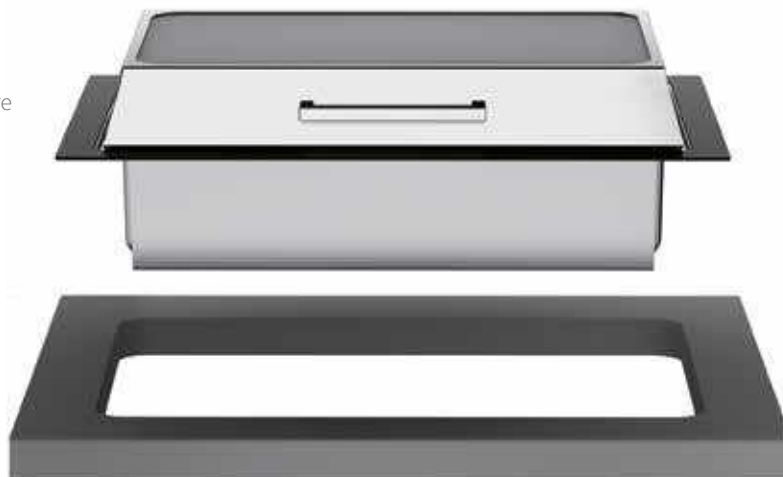

Completo di due fornelli a combustibile solido
e predisposto per piastra elettrica
Portavivande in acciaio incluso

With two solid fuel burners,
electric heating element available.
With GN 1/1 Gastronorm food pan

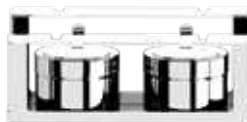

Scaldavivande con gambe e coperchio in acciaio Inox

Chafing dish with St. Steel stand and cover
Chafing dish avec support et couvercle en acier Inox
Chafing Dish mit Beinen und Edelstahldeckel
Chafing dish con soporte y tapa en acero Inox

	GN	Cm	H Cm
V87 18 52 001	1/1	63x42	31
		In	H In
		25,3/4x16,1/2	12,1/4

2 fornelli - 2 burners

	GN	Cm	H Cm
V87 18 52 004	2/3	46x42	32
		In	H In
		18,1/8x16,1/2	12,5/8

1 fornello - 1 burner



Completo di due fornelli a combustibile solido e predisposto per piastra elettrica. Portavivande in acciaio incluso

With two solid fuel burners, electric heating element available. With Gastronorm food pan

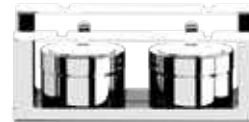

Scaldavivande con gambe e coperchio acciaio Inox/vetro

Chafing dish with St. Steel/glass stand and cover
Chafing dish avec support et couvercle en acier Inox / verre
Chafing Dish mit Beinen und Edelstahl / Glasdeckel
Chafing dish con soporte y tapa en acero Inox / vidrio

	GN	Cm	H Cm
V87 18 52 005	1/1	63x42	33
		In	H In
		25,3/4x16,1/2	12,1/4

2 fornelli - 2 burners

	GN	Cm	H Cm
V87 18 52 006	2/3	46x42	32
		In	H In
		18,1/8x16,1/2	12,5/8

1 fornello - 1 burner



Completo di due fornelli a combustibile solido e predisposto per piastra elettrica. Portavivande in acciaio incluso

With two solid fuel burners, electric heating element available. With GN 1/1 Gastronorm food pan

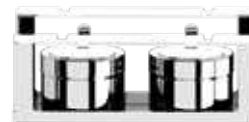

Caratteristiche tecniche

- A** Asportabilità del coperchio a 90° con estrema facilità.
- B** Coperchio leggero e facilmente maneggiabile.
- C** Blocco automatico dell'estrazione del coperchio in fase di lavoro (da 0° a 89°).
- D** Chiusura e apertura frenata del coperchio. Sistema di cerniere brevettate Abert
- E** Il coperchio si ferma, quando è lasciato, in qualsiasi posizione da 0° a 70°.
- F** Superati i 70° il coperchio si apre completamente lasciandolo andare.
- G** La cerniera è un meccanismo a molla, inalterabile nel tempo, non necessita di regolazione e di manutenzione in quanto non ha frizione.
- H** Tutti i meccanismi sono costruiti in pregiati materiali inossidabili, quindi resistenti alla corrosione, agli ambienti umidi e adatti al contatto con gli alimenti.
- I** Lo scaldavivande è progettato per raccogliere la condensa in modo da lasciare il piano di appoggio completamente asciutto.
- L** Può essere utilizzato sia con riscaldamento elettrico sia con fornelli a combustibile solido.

Technical characteristics

- A** Easily removable cover, at 90°.
- B** Light and easy-to-handle cover.
- C** Automatic block of cover pull out when in operation (from 0° to 89°).
- D** Closing and opening slowed by cover. Abert patented system.
- E** The cover stops, when released, in any position from 0° to 70°.
- F** Over 70° the cover opens fully when released.
- G** The hinge is a spring mechanism, inalterable in time, it does not need regulation and maintenance as it has no clutch.
- L** All the machineries are built in refined stainless materials, thus resistant to corrosion, humid environment and suitable for food contact.
- I** The chafing dish is designed to collect condensation, in order to keep the support base completely dry.
- L** Both electric warming and solid-fuelburners can be used.

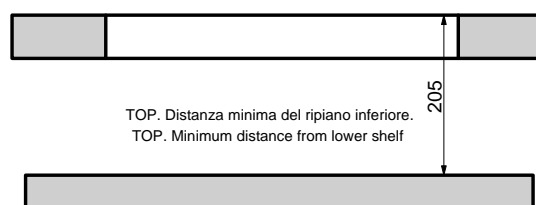
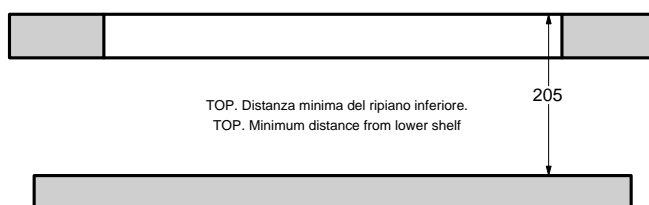
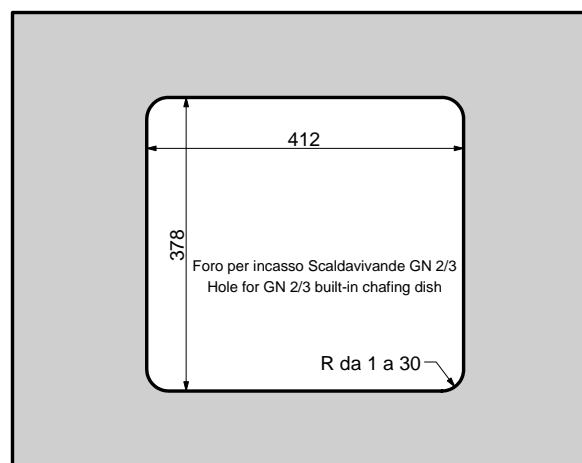
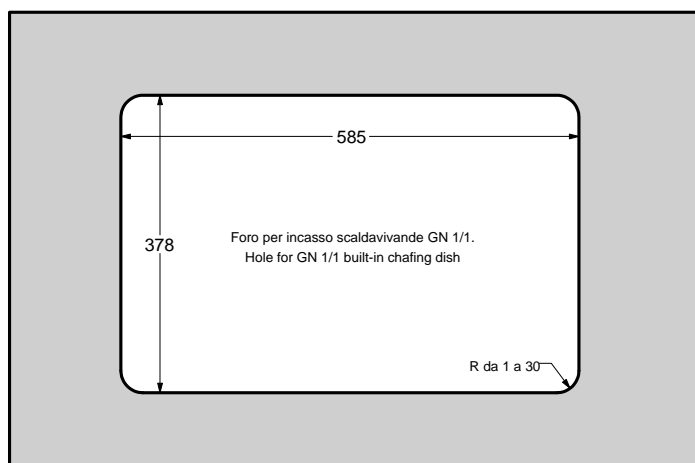





Scaldavivande GN 1/1 per supporti Urban

GN 1/1 built-in chafing dish
Chafing dish encastrable GN 1/1
Eingebautes Chafing Dish GN 1/1
Chafing dish empotrable GN 1/1

V87 18 520 02 Con coperchio in acciaio Inox - With st. Steel cover
V87 18 520 03 Con coperchio in vetro - With glass cover

Predisposto per piastra elettrica. Portavivande GN 1/1 in acciaio incluso. Supporti Urban e fornelletti esclusi.

Electric heating element available. With GN 1/1 Gastronorm food pan. Urban stand and burners excluded.



Coperchio GN 1/1 in acciaio Inox

GN 1/1 St. Steel cover
Couvercle en acier Inox GN 1/1
Edelstahldeckel GN 1/1
Tapa de acero Inox GN 1/1

	H Cm	H In	
B03 05 52 665	7,2	2,3/4	Acciaio inossidabile - St. Steel
G03 05 52 679	7,2	2,3/4	Vetro - Glass



Inserto GN 1/1 acciaio Inox

GN 1/1 container
Conteneur GN 1/1
Gn - Behälter 1/1
Contenedor GN 1/1

	H Cm	H In
V01 05 72 G11 B	6,5	2,1/2



Bagnomaria GN 1/1 acciaio Inox

Pan
Bassine
Einsatz tief
Cubeta

	H Cm	H In
305 05 52 666	11	4,3/8



Fornelletto per scaldavivande

Chafing-dish burner
Porte brûleur pour chafing dish
Brennstoffhalter für Chafing Dish
Contenedor de combustible para chafing dish

V77 05 52 FDC Fornelletto - Burner (Venduto a parte)
B25 05 52 665 Supporto - Support



Supporto per set refrigerato

Stand for thermal set
Support pour set réfrigéré
Ständer für Thermo-Einsatz
Soporte para set refrigerado

V87 18 42 PCH7



Set refrigerato a incastro GN 1/1

GN 1/1 built-in thermal set
Set réfrigéré encastrable GN 1/1
Eingebautes Thermo-Einsatz GN 1/1
Set refrigerado empotrable GN 1/1

V87 18 520 07 Con coperchio in vetro - With glass cover

Set refrigerato GN 1/1 H7,2 Cm completo di bacinella in acciaio Inox, griglia in acciaio Inox, eutettici, vassoio GN 1/1 HCm 2 in acciaio Inox. Supporti Urban esclusi.

Thermal set GN 1/1 H 7,2 Cm with st. Steel pan, st. Steel grid, ice packs, st. Steel tray GN 1/1 H Cm 2. Urban stand exclude



Coperchio GN 1/1 in vetro

GN 1/1 glass cover
Couverche en verre GN 1/1
Glasdeckel GN 1/1
Tapa de vidrio GN 1/1

	H Cm	H In
G03 05 52 670	7,2	2,3/4



Inserto GN 1/1 acciaio Inox

GN 1/1 container
Conteneur GN 1/1
Gn - Behälter 1/1
Contenedor GN 1/1

	H Cm	H In
V01 05 72 G11	2	0,3/4



Griglia

Grid
Grille
Gittereinsatz
Reja

	H Cm	H In
B4 705 52 668	2	0,3/4



Eutettico

Ice pack
Bloc réfrigérant
Kühlakku
Acumulador de frío

V77 12 95 G00



Bacinella GN 1/1 acciaio Inox

Pan
Bassine
Einsatz tief
Cubeta

	H Cm	H In
305 05 52 671	7,5	3



Supporto per set refrigerato

Stand for thermal set
Support pour set réfrigéré
Ständer für Thermo-Einsatz
Soporte para set refrigerado

V87 18 42 PCH1

Inserto GN 1/1

GN 1/1 container
 Conteneur GN 1/1
 Gn - Behälter 1/1
 Contenedor GN 1/1

Inox 18/10 - St. Steel

	Cm	H Cm	Sp. Mm
V01 05 72 G11	53x32,5	2	0,7
V01 05 72 G11 B	53x32,5	6,5	0,7

**Inserto GN 2/3**

GN 2/3 container
 Conteneur GN 2/3
 Gn - Behälter 2/3
 Contenedor GN 2/3

Inox 18/10 - St. Steel

	Cm	H Cm	Sp. Mm
V01 05 72 G23	35,4x32,5	2	0,7
V01 05 72 G23 B	35,4x32,5	6,5	0,7

**Inserto GN 1/3**

GN 1/3 container
 Conteneur GN 1/3
 Gn - Behälter 1/3
 Contenedor GN 1/3

Inox 18/10 - St. Steel

	Cm	H Cm	Sp. Mm
V01 05 72 G13	32,5x17,6	2	0,7
V01 05 72 G13 A	32,5x17,6	4	0,7

**Inserto GN 1/2**

GN 1/2 container
 Conteneur GN 1/2
 Gn - Behälter 1/2
 Contenedor GN 1/2

Inox 18/10 - St. Steel

	Cm	H Cm	Sp. Mm
V01 05 72 G12	32,5x26,5	2	0,7
V01 05 72 G12 B	32,5x26,5	6,5	0,7

**Piastra elettrica**

Electric hot plate
 Plaque électrique
 Elektrische Platte
 Placa eléctrica

V77 05 52 PCR

V77 05 52 PCR1 Con regolatore - With regulator



Inserto GN 1/1

Food pan, GN 1/1
 Conteneur GN 1/1
 Porzellanbehälter, GN 1/1
 Contenedor GN 1/1

Porcellana - Porcelain

	H Cm	H In
V01 21 52 G11B	6,5	2,1/2
V01 21 52 G11	2	0,3/4

**Inserto GN 2/3**

Food pan, GN 2/3
 Conteneur GN 2/3
 Porzellanbehälter, GN 2/3
 Contenedor GN 2/3

Porcellana - Porcelain

	H Cm	H In
V01 21 52 G23B	6,5	2,1/2

**Inserto GN 1/2**

Food pan, GN 1/2
 Conteneur GN 1/2
 Porzellanbehälter, GN 1/2
 Contenedor GN 1/2

Porcellana - Porcelain

	H Cm	H In
V01 21 52 G12B	6,5	2,1/2

**Inserto GN 1/3**

Food pan, GN 1/3
 Conteneur GN 1/3
 Porzellanbehälter, GN 1/3
 Contenedor GN 1/3

Porcellana - Porcelain

	H Cm	H In
V01 21 52 G13B	6,5	2,1/2

**Piatto piano quadrato**

Square flat plate
 Assiette carré
 Teller
 Plato cuadrado

Porcellana - Porcelain

	Cm	H In
V01 21 42 P22	22x22	8,5/8x8,5/8







Tower

Tower
Tower
Tower
Tower

Ferro verniciato - Varnished Iron

	H Cm	H In
V87 18 42 002	22	8,5/8
V87 18 42 003	34	13,3/8
V87 18 42 004	58	22,7/8

**Contentore Urban Organizer**

Urban Organizer container
Conteneur Urban Organizer
Urban-Organizer Holzbehälter
Contenedor Urban Organizer

Legno - Wood

	Cm	In
V87 04 42 CS1	10x10x8	4x4x3,1/8

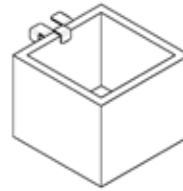
**Contentore Urban Organizer**

Urban Organizer container
Conteneur Urban Organizer
Urban-Organizer Holzbehälter
Contenedor Urban Organizer

Legno - Wood

	Cm	In
V87 04 42 CS2	15x10x46x4x1,1/2	

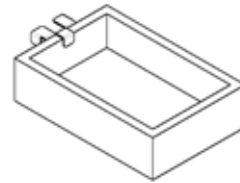
**Contentore Urban Organizer**

Urban Organizer container
Conteneur Urban Organizer
Urban-Organizer Holzbehälter
Contenedor Urban Organizer

Legno - Wood

	Cm	In
V87 04 42 CS3	20x15x4	7,7/8x6x1,1/2
V87 04 42 CS4	20x15x8	7,7/8x6x3,1/8

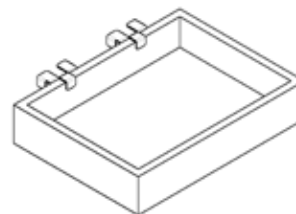
**Contentore Urban Organizer**

Urban Organizer container
Conteneur Urban Organizer
Urban-Organizer Holzbehälter
Contenedor Urban Organizer

Legno - Wood

	Cm	In
V87 04 42 CS5	35x17,5x4	13,3/4x6,7/8x1,1/2
V87 04 42 CS6	35x17,5x8	13,3/4x6,7/8x3,1/8

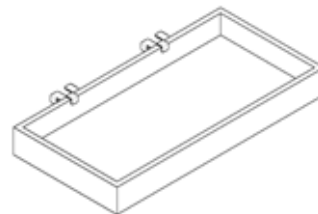
**Contentore Urban Organizer**

Urban Organizer container
Conteneur Urban Organizer
Urban-Organizer Edelstahlbehälter
Contenedor Urban Organizer

Inox 18/10 - St. Steel

	Cm	In
V87 05 42 CS1	6,5x10x4	2,1/2x4x1,1/2

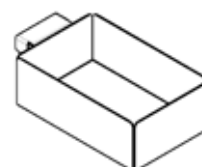

Contenitore Urban Organizer

Urban Organizer container
 Conteneur Urban Organizer
 Urban-Organizer Edelstahlbehälter
 Contenedor Urban Organizer

Inox 18/10 - St. Steel

	Cm	In
V87 05 42 CS2	10x6,5x4	4x2,2/1x1,1/2

**Contenitore Urban Organizer**

Urban Organizer container
 Conteneur Urban Organizer
 Urban-Organizer Edelstahlbehälter
 Contenedor Urban Organizer

Inox 18/10 - St. Steel

	Cm	In
V87 05 42 CS3	18x4,5x4	7x1,3/4 x1,1/2

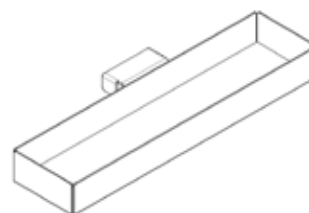
**Contenitore cilindrico per anello**

Cylindrical container for ring
 Conteneur cylindrique pour anneau
 Zylindrische Edelstahlbehälter für Ring
 Contenedor cilíndrico para anillo

Inox 18/10 - St. Steel

	Ø Cm	Ø In	H Cm	H In
V87 05 42 CS4	7,6	30	9,5	3,3/4

**Anello Urban Organizer**

Urban Organizer ring
 Anneau Urban organizer
 Edelstahlring für Urban-Organizer
 Anillo Urban Organizer

Inox 18/10 - St. Steel

	Ø Cm	Ø In
V87 05 42 A01	9	35,3/8

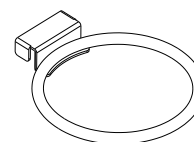
**Base per Tower Urban Organizer verniciata con perni**

Urban Organizer varnished, stand with pins
 Support Urban Organizer verni avec pivots
 Lackiert Gestell für Urban Tower, mit Zapfen
 Soporte Urban Organizer varnizado con pivotes

Ferro Verniciato - Varnished Iron

	Cm	In
V87 18 42 B02	30x30	11,3/4x11,3/4

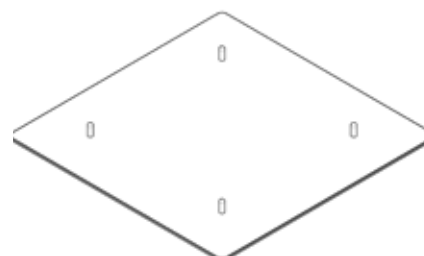
**Vassoio Urban Organizer**

Urban Organizer tray
 Plateau Urban Organizer
 Edelstahl Tablett für Urban Organizer
 Bandeja Urban Organizer

Inox 18/10 - St. Steel

	Cm	In
V87 05 42 V01	20x19	7,7/8x7,1/2

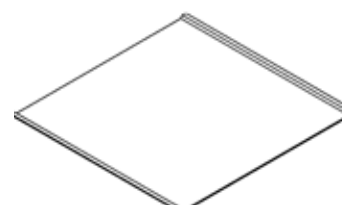





Revolution

Un'idea nuova ed originale nel concetto Buffet: **Mix&Play Revolution** consente con un tocco di creatività e fantasia di presentare cibi, bevande, stuzzichini ecc. ispirandosi ai diversi momenti di consumo (dalla colazione all'aperitivo) e alle tipologie dei locali. Un'opera d'arte che coniuga modernità e funzionalità in un prodotto che non ha eguali.

Le strutture in alluminio sono state pensate per soddisfare le differenti esigenze di spazio e di consumo del cliente. Sono l'esempio per eccellenza del concetto modulare consentendo la composizione di 5 differenti misure delle basi (2 quadrate e 3 rettangolari) per 3 differenti altezze. Con la creatività è possibile adattare **Mix&Play Revolution** Buffet al proprio spazio e creare sempre nuove ed originali presentazioni.

7 nuove composizioni studiate per facilitare la creazione del vostro buffet.

*A new and original idea for the buffet: **Mix&Play Revolution** allows to present food and beverages etc. at different times of the day and different kinds of place, with an incredible touch of creativity and fantasy. A work of art that matches modern day practicality in just one product. The only one!*

*The metal podio are created to satisfy the different needs of space and consumption. They are easy excellent example of modular concept allowing the composition of 5 different sizes of base (2 square and 3 rectangular) for 3 different heights. By being creative it is possible to adapt **Mix&Play Revolution** Buffet to any kind of space and always provide new and fantastic Buffet.*

7 new arrangements studied to make the preparation of your buffet easier.

Set 1

Set 1
Set 1
Set 1
Set 1

V86 32 42 003 Nero-Black
V86 32 42 010 Silver-Silver

Cm	H Cm	In	H In
52,5x70	24	20,5/8x27,1/2	9,1/2

**Set 2**

Set 2
Set 2
Set 2
Set 2

V86 32 42 004 Nero-Black
V86 32 42 011 Silver-Silver

Cm	H Cm	In	H In
35x70	24	13,3/4x27,1/2	9,1/2

**Set 3**

Set 3
Set 3
Set 3
Set 3

V86 32 42 005 Nero-Black
V86 32 42 012 Silver-Silver

Cm	H Cm	In	H In
52,5x70	22,5	20,5/8x27,1/2	8,7/8

**Set 4**

Set 4
Set 4
Set 4
Set 4

V86 32 42 006 Nero-Black
V86 32 42 013 Silver-Silver

Cm	H Cm	In	H In
52,5x70	22,5	20,5/8x27,1/2	8,7/8



Set 5

Set 5
Set 5
Set 5
Set 5

V86 32 42 007 Nero-Black
V86 32 42 014 Silver-Silver

Cm	H Cm	In	H In
52,5x70	16	20,5/8x27,1/2	6,1/4



Set 6

Set 6
Set 6
Set 6
Set 6

V86 32 42 008 Nero-Black
V86 32 42 015 Silver-Silver

Cm	H Cm	In	H In
52,5x52,5	16	20,5/8x20,5/8	6,1/4



Set 7

Set 7
Set 7
Set 7
Set 7

V86 32 42 009 Nero-Black
V86 32 42 016 Silver-Silver

Cm	H Cm	In	H In
52,5x52,5	16	20,5/8x20,5/8	6,1/4



Set Large

Set Large
Set Large
Set Large
Set Large

V86 32 42 L05 Nero-Black
V86 32 42 L06 Silver-Silver

Cm	H Cm	In	H In
122,5x87,5	30,5	48,1/4x34,1/2	12

**Set Small**

Set Small
Set Small
Set Small
Set Small

V86 32 42 S05 Nero-Black
V86 32 42 S08 Silver-Silver

Cm	H Cm	In	H In
87,5x52,5	26,5	34,1/2x20,5/8	10,3/8



Alzata modulare quadrata

Square modular podium
Etagère modulaire carrée
Modulständer, viereckig
Expositor modular cuadrado

	Cm	H Cm	In	H In
Argento - Silver				
V86 11 42 Q01	17,5x17,5	9,5	6,7/8x6,7/8	3,3/4
V86 11 42 Q02	17,5x17,5	16	6,7/8x6,7/8	6,1/4
V86 11 42 Q03	17,5x17,5	22,5	6,7/8x6,7/8	8,7/8
Nero - Black				
V86 15 42 Q01	17,5x17,5	9,5	6,7/8x6,7/8	3,3/4
V86 15 42 Q02	17,5x17,5	16	6,7/8x6,7/8	6,1/4
V86 15 42 Q03	17,5x17,5	22,5	6,7/8x6,7/8	8,7/8



Alzata modulare quadrata

Square modular podium
Etagère modulaire carrée
Modulständer, viereckig
Expositor modular cuadrado

	Cm	H Cm	In	H In
Argento - Silver				
V86 11 42 Q04	35x35	9,5	13,3/4x13,3/4	3,3/4
V86 11 42 Q05	35x35	16	13,3/4x13,3/4	6,1/4
V86 11 42 Q06	35x35	22,5	13,3/4x13,3/4	8,7/8
Nero - Black				
V86 15 42 Q04	35x35	9,5	13,3/4x13,3/4	3,3/4
V86 15 42 Q05	35x35	16	13,3/4x13,3/4	6,1/4
V86 15 42 Q06	35x35	22,5	13,3/4x13,3/4	8,7/8



Alzata modulare rettangolare

Rectangular modular podium
Etagère modulaire rectangulaire
Modulständer, rechteckig
Expositor modular rectangular

	Cm	H Cm	In	H In
Argento - Silver				
V86 11 42 R01	17,5x35	9,5	6,7/8x13,3/4	3,3/4
V86 11 42 R02	17,5x35	16	6,7/8x13,3/4	6,1/4
V86 11 42 R03	17,5x35	22,5	6,7/8x13,3/4	8,7/8
Nero - Black				
V86 15 42 R01	17,5x35	9,5	6,7/8x13,3/4	3,3/4
V86 15 42 R02	17,5x35	16	6,7/8x13,3/4	6,1/4
V86 15 42 R03	17,5x35	22,5	6,7/8x13,3/4	8,7/8



Alzata modulare rettangolare

Rectangular modular podium
Etagère modulaire rectangulaire
Modulständer, rechteckig
Expositor modular rectangular

	Cm	H Cm	In	H In
Argento - Silver				
V86 11 42 R04	17,5x52,5	9,5	6,7/8x20,5/8	3,3/4
V86 11 42 R05	17,5x52,5	16	6,7/8x20,5/8	6,1/4
V86 11 42 R06	17,5x52,5	22,5	6,7/8x20,5/8	8,7/8
Nero - Black				
V86 15 42 R04	17,5x52,5	9,5	6,7/8x20,5/8	3,3/4
V86 15 42 R05	17,5x52,5	16	6,7/8x20,5/8	6,1/4
V86 15 42 R06	17,5x52,5	22,5	6,7/8x20,5/8	8,7/8



Alzata modulare rettangolare

Rectangular modular podium
Etagère modulaire rectangulaire
Modulständer, rechteckig
Expositor modular rectangular

	Cm	H Cm	In	H In
Argento - Silver				
V86 11 42 R07	35x52,5	9,5	13,3/4x20,5/8	3,3/4
V86 11 42 R08	35x52,5	16	13,3/4x20,5/8	6,1/4
V86 11 42 R09	35x52,5	22,5	13,3/4x20,5/8	8,7/8
Nero - Black				
V86 15 42 R07	35x52,5	9,5	13,3/4x20,5/8	3,3/4
V86 15 42 R08	35x52,5	16	13,3/4x20,5/8	6,1/4
V86 15 42 R09	35x52,5	22,5	13,3/4x20,5/8	8,7/8



Piano legno quadrato

Square wooden base
 Tablette en bois carrée
 Holzplatte, viereckig
 Tablero de madera cuadrado

	Cm	H Cm	In	H In
V86 04 42 PQ1	17,5x17,5	0,8	6,7/8x6,7/8	0,3/8

**Piano legno rettangolare**

Rectangular wooden base
 Tablette en bois rectangulaire
 Holzplatte, rechteckig
 Tablero de madera rectangular

	Cm	H Cm	In	H In
V86 04 42 PR1	17,5x35	0,8	6,7/8x13,3/4	0,3/8

**Supporto legno inclinato quadrato**

Square modular podium
 Etagère modulaire carrée
 Holzgestell, viereckig, schräg gestellt
 Expositor modular cuadrado

	Cm	H Cm	In	H In
V86 04 42 SQ1	35x35	7,5	13,3/4x13,3/4	3

**Supporto legno inclinato rettangolare**

Rectangular modular podium
 Etagère modulaire rectangulaire
 Holzgestell, viereckig, schräg gestellt
 Expositor modular rectangular

	Cm	H Cm	In	H In
V86 04 42 SR1	35x52,5	7,5	13,3/4x20,5/8	3



Vassoio legno quadrato

Square wooden tray
 Plateau en bois carrée
 Holztablett, viereckig
 Bandeja de madera cuadrado

	Cm	H Cm	In	H In
V86 04 42 VQ1	35x35	4	13,3/4x13,3/4	1,1/2
V86 04 42 VQ2	35x35	8	13,3/4x13,3/4	3,1/8



Vassoio legno rettangolare

Rectangular wooden tray
 Plateau en bois rectangulaire
 Holztablett, rechteckig
 Bandeja de madera rectangular

	Cm	H Cm	In	H In
V86 04 42 VR1	17,5x35	4	6,7/8x13,3/4	1,1/2
V86 04 42 VR2	17,5x35	8	6,7/8x13,3/4	3,1/8



Vassoio legno rettangolare

Rectangular wooden tray
 Plateau en bois rectangulaire
 Holztablett, rechteckig
 Bandeja de madera rectangular

	Cm	H Cm	In	H In
V86 04 42 VR3	17,5x52,5	4	6,7/8x20,5/8	1,1/2
V86 04 42 VR4	17,5x52,5	8	6,7/8x20,5/8	3,1/8



Vassoio legno rettangolare

Rectangular wooden tray
 Plateau en bois rectangulaire
 Holztablett, rechteckig
 Bandeja de madera rectangular

	Cm	H Cm	In	H In
V86 04 42 VR5	35x52,5	4	13,3/4x20,5/8	1,1/2
V86 04 42 VR6	35x52,5	8	13,3/4x20,5/8	3,1/8



Piatto quadrato porcellana

Square porcelain platter
 Plat carré en porcelaine
 Porzellanteller, viereckig
 Plato cuadrado de porcellana

	Cm	In
V86 21 42 PQP	17,5x17,5	6,7/8x6,7/8

**Piatto quadrato porcellana**

Square porcelain platter
 Plat carré en porcelaine
 Porzellanteller, viereckig
 Plato cuadrado de porcellana

	Cm	In
V86 21 42 PQG	35x35	13,3/4x13,3/4

**Piatto rettangolare porcellana**

Rectangular porcelain platter
 Plat rectangulaire en porcelaine
 Porzellanteller, rechteckig
 Plato rectangular de por

	Cm	In
V86 21 42 PRE	17,5x35	6,7/8x13,3/4

**Teglia rettangolare in porcellana**

Rectangular porcelain baker
 Plate a roti rectangular en porcelaine
 Porzellanbackform, rechteckig
 Fuente rectangular porcelana

	Cm	In
V86 21 42 TRE	17,5x35	6,7/8x13,3/4

**Teglia quadrata in porcellana**

Square porcelain baker
 Plate a roti carré en porcelaine
 Porzellanbackform, viereckig
 Fuente cuadrada de porcelana

	Cm	In
V86 21 42 TQU	35x35	13,3/4x13,3/4



Ciotola quadra porcellana

Porcelain bowl
Bol carré en porcelaine
Porzellanschale, viereckig
Bol cuadrado de porcellana

	Cm	H Cm	In	H In
V86 21 42 CQ14	14x14	8	5,1/2x5,1/2	3,1/8



Ciotola quadra porcellana

Porcelain bowl
Bol carré en porcelaine
Porzellanschale, viereckig
Bol cuadrado de porcellana

	Cm	H Cm	In	H In
V86 21 42 CQ7	7x7	3,5	2,3/4x2,3/4	1,3/8



Bicchieri vetro basso

Glass glass, small
Verre Ginco
Glass, klein
Vaso cristal bajo

	ø Cm	H Cm	Lt
V86 08 42 BBA	6	8	0,10
	ø In	H In	Oz
	2,3/8	3,1/8	3,5



Bicchieri vetro alto

Glass glass, tall
Verre en verre haut
Glass, hoch
Vaso cristal alto

	ø Cm	H Cm	Lt
V86 08 42 BAL	7	11	0,15
	ø In	H In	Oz
	2,3/4	4,3/8	5



Coppa in vetro

Glass bowl
Coupelle en verre
Glasschale
Bol de vidrio

	ø Cm	H Cm	ø In	H In
V86 08 42 C12	12	7	4,3/4	2,3/4



Set ABS

Set 1

Set 1

Set 1

Set 1

	Cm	H Cm	In	H In
V86 32 42 S06 Nero-Black	87x52,5	23	34,1/4x20,5/8	9
V86 32 42 S07 Silver-Silver	87x52,5	23	34,1/4x20,5/8	9



Piano in ABS nero quadrato liscio

Square plain black ABS base

Plat carré en abs noir

ABS Platte, schwarz viereckig und glatt

Base en ABS negra cuadrada lisa

	Cm	In
V86 12 42 QLI 15	17,5x17,5	6,7/8x6,7/8

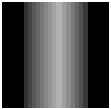
**Piano in ABS nero rettangolare liscio**

Rectangular plain black ABS base

Plat rectangulaire en ABS noir

ABS Platte, schwarz rechteckig und glatt

Base en ABS negra cuadrada lisa

	Cm	In
V86 12 42 RLI 15	17,5x35	6,7/8x13,3/4

**Piano abs nero quadrato 1 foro grande**

Square Abs base with 1 hole

Plat carré en abs noir 1 trou grand

ABS Platte, schwarz mit einem Loch

Base en ABS negra con 1 agujero grande

	Cm	In
V86 12 42 Q1F 15	17,5x17,5	6,7/8x6,7/8

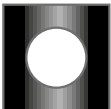
**Piano abs nero rettangolare 2 fori grandi**

Rectangular Abs base with 2 holes

Plat rectangulaire en ABS noir 2 trous grands

ABS Platte, schwarz rechteckig und mit 2 großen Löcher

Base en ABS negra rectangular, con 2 agujeros grandes

	Cm	In
V86 12 42 R2F 15	17,5x35	6,7/8x13,3/4

**Piano abs nero quadrato 4 fori piccoli**

Square Abs base with 4 holes

Plat carré en ABS noir 4 trous petits

ABS Platte, schwarz viereckig mit 4 kleinen Löcher

Base en ABS negra cuadrada con 4 agujeros pequeños

	Cm	In
V86 12 42 Q4F 15	17,5x17,5	6,7/8x6,7/8

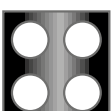
**Piano abs nero rettangolare 8 fori piccoli**

Rectangular Abs base with 8 holes

Plat rectangulaire en ABS noir 8 trous petits

ABS Platte, schwarz viereckig mit 8 kleinen Löcher

Base en ABS negra rectangular, con 8 agujeros pequeños

	Cm	In
V86 12 42 R8F 15	17,5x35	6,7/8x13,3/4

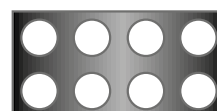

Distributore succhi

Juice dispenser
Distributeur jus
Saftdispenser
Dispensador de zumo

**Con rubinetto in metallo**

With metal tap
Avec robinet en métal
Mit Metallhahn
Con grifo de metal

	Lt	Oz	Cm	H Cm	In	H In
V76 05 52 00 8R	3,5	118	20x31,5	51	7,3/4x12,1/2	20
V76 05 52 00 2R	7	237	27x37	56	10,5/8x14,1/2	22
V76 05 52 01 2R	12	405	27x37	51	10,5/8x14,1/2	20

**Con rubinetto in plastica**

With plastic tap
Avec robinet en plastique
Mit Kunststoffhahn
Con grifo de plástico

	Lt	Oz	Cm	H Cm	In	H In
V76 05 52 00 9R	3,5	118	20x31,5	51	7,3/4x12,1/2	20
V76 05 52 00 3R	7	237	27x37	56	10,5/8x14,1/2	22
V76 05 52 01 3R	12	405	27x37	51	10,5/8x14,1/2	20

**Portaformaggi-affettati rettangolare refrigerato**

Thermal rectangular cheese dish
Plateau fromage - charcuterie rectangulaire réfrigérant
Rechteckige Aufschnittplatte, gekühlt
Quesera rectangular refrigerante

	Cm	H Cm	In	H In
V76 05 54 R0 1R	50x30	20	19,3/4x11,3/4	7,7/8





Distributore caffè

Coffee urn
Distributeur de café
Kaffeedispenser
Dispensador de café

	Lt	Cm	HCm
V76 05 52 00 1R	10	26x33	64
	Oz	In	H In
	350	10,1/4x13	25,1/8



Distributore cereali singolo

Cereal dispenser
Distributeur céréales
Müeslidispenser
Dispensador de cereales

	Lt	Cm	HCm
V76 05 52 01 0R	4	19,5x29	56
	Oz	In	H In
	135	7,3/4x11,3/8	22

	Lt	Cm	HCm
V76 05 52 01 1R	7	19,5x29	70
	Oz	In	H In
	237	7,3/4x11,3/8	27,7/8





BUFFET SQUARE

Portaformaggi-affettati rettangolare refrigerato Square

Thermal rectangular cheese dish Square

Plateau fromage-charcuterie rectangulaire réfrigérant Square

Rechteckige Aufschnittplatte, gekühlt, Square

Quesera rectangular refrigerante Square

Inox 18/10 - St. Steel

	Cm	H Cm	In	H In
V76 05 54 R01	50x30	20	19,5/8x11,7/8	7,7/8



Coperchio a bascula rettangolare trasparente

Transparent rectangular rolltop cover

Cloche basculante rectangulaire transparente

Rolltophaube-rechteckig

Campana rectangular transparente

SAN

	Cm	In
V76 12 15 R01	47x27	18,1/2x10,5/8

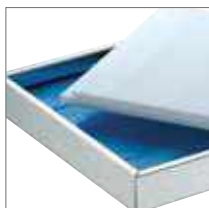

Tagliere rettangolare

Rectangular cutting board

Planche à découper rectangulaire

Rechteckiges Schneidebrett

Tabla de cortar rectangular

Polietilene

	Cm	In
V77 12 71 R01	47x27	18,1/2x10,5/8



4 Eutettici rettangolari

4 Ice packs

4 Blocs réfrigérants

4 Kühlakkus

4 Acumuladores de frío rectangulares

V77 12 95 M00



Alzata filo per basi rettangolari

Square wire stand for rectangular bases

Support en fil pour bases rectangulaires

Drahtständer für rechteckigen Sockel

Soporte filo de acero para bases rectangulares

Inox 18/10 - St. Steel

	Cm	H Cm
V76 05 42 001	50x30	27,5

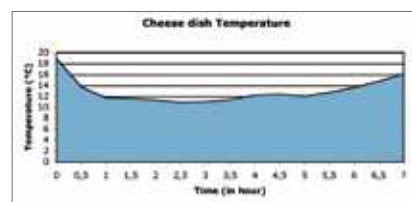

Temperatura ambiente
External temperature

19,6°

Temperatura acqua
Water temperature

18,9°

Mezzo refrigerante
Cooler system

8 eutettici ghiaccio piccoli
8 small ice packs

Portaformaggi-affettati tondo refrigerato Square

Thermal round cheese dish Square

Plateau fromage-charcuterie rond réfrigérant Square

Runde Aufschnittplatte, gekühlt, Square

Quesera redonda refrigerante Square

Inox 18/10 - St. Steel

	Cm	H Cm	In	H In
V76 05 54 T01	38x38	23	14,8/8x14,8/8	9



Coperchio a bascula tondo trasparente

Transparent round rolltop cover

Cloche basculante ronde transparente

Rolltophaube - rund

Campana redonda transparente

SAN

	ø Cm	ø In
V76 12 15 T01	34	13,3/8



Tagliere quadrato con scanal. tonda

Square cutting board with round groove

Planche à découper carrée avec rainure ronde

Viereckiges Schneidebrett mit runder Rille

Tabla de cortar cuadrada con ranura

Polietilene

	Cm	In
V77 12 71 T01	35x35	13,3/4x13,3/4



Eutettici rettangolari

Ice packs

Blocs réfrigérants

Kühlakkus

Acumuladores de frío rectangulares

V77 12 95 M00

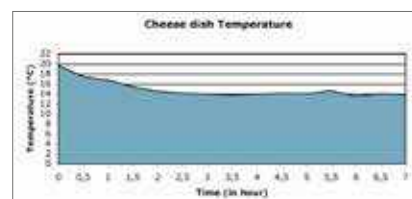

Temperatura ambiente
External temperature 20,9°

Temperatura acqua
Water temperature 19,5°

Mezzo refrigerante
Cooler system 4 eutettici ghiaccio piccoli
4 small ice packs

Distributore succhi Square

Square juice dispenser

Distributeur jus Square

Saftdispenser Square

Dispensador de zumo Square

**Con rubinetto in metallo**

With metal tap

Avec robinet en métal

Mit Metallhahn

Con grifo de metal

	Cm	H Cm	Lt	Oz
V76 05 52 008	18x27,5	46	3,5	118
V76 05 52 002	24x31	50	7	237
V76 05 52 012	24x31	70	12	405

**Con rubinetto in plastica**

With plastic tap

Avec robinet en plastique

Mit Kunststoffhahn

Con grifo de plástico

	Cm	H Cm	Lt	Oz
V76 05 52 009	17,5x27,5	41	3,5	118
V76 05 52 003	23,5x31	50	7	237
V76 05 52 013	23,5x31	78	12	405

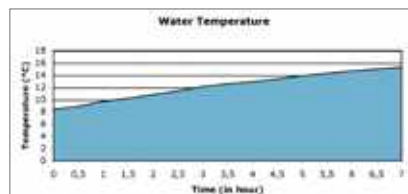

Temperatura ambiente
External temperature 20,0°

Temperatura acqua
Water temperature 7,6°

Quantità acqua inserita
Quantity of water added 7 Lt

Distributore caffè Square

Coffee urn 10 Lt
 Distributeur de café 10 Lt
 Kaffeedispenser 10 Lt
 Dispensador de café 10 Lt

	Cm	H Cm	Lt	Oz
V76 05 52 001	24x31	61	10	350



Fornelletto per scaldavivande / distributore caffè

Burner for chafing dish/coffee urn
 Porte bruleur pour chafing dish et distributeur café
 Brennstoffhalter für Chafing Dish und Kaffeedispenser
 Contenidor de combustible para chafing dish - dispensador de café

V77 05 52 FDC



Piastra elettrica per distributore caffè

Heating element for coffee urn
 Plaque électrique pour distributeur de café
 Elektro-Heizelement für Kaffeedispenser
 Plancha eléctrica para dispensador de café

	ø Cm	ø In
V77 05 52 PDC	14	5,1/2

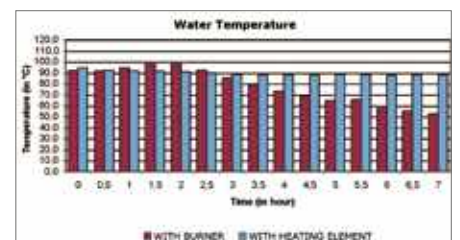

Temperatura ambiente
 External temperature 20,0°

Temperatura acqua
 Water temperature 92,5°/98,8°

Quantità acqua inserita
 Quantity of water added 8 Lt

Distributore cereali singolo Square

Square cereal dispenser

Distributeur céréales Square

Mueslidispenser Square

Dispensador de cereales Square

	Cm	H Cm	Lt	Oz
V76 05 52 010	18x27	53	4	135
V76 05 52 011	18x27	68	7	237



Tagliere per pane base acciaio Square

Square bread cutting board with St. Steel base
 Planche à découper à pain Square avec base en acier Inoxidable
 Brotschneidebrett Square mit Stahlgestell
 Tabla de cortar pan Square con base de acero Inoxidable

	Cm	In
V76 05 54 001	50x30	19,5/8x11,7/8

V76 04 71 001 **50x30** **19,5/8x11,7/8**
 Solo tagliere

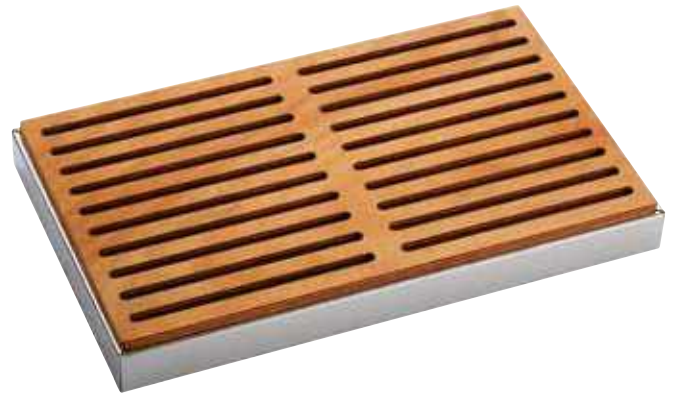

Cestino pane acciaio per buffet Square

Square bread basket for buffet, St. Steel
 Corbeille à pain en acier pour buffet Square
 Brotkorb Square für Buffet, Edelstahl
 Cesta pan en acero para buffet Square

	Cm	In
V76 05 24 001	50x30	19,5/8x11,7/8



Scaldabrioche Square con termostato

Square croissant warmer
 Chauffe - croissants Square
 Croissantwärmer Square
 Calentador croissants Square

	Cm	In
V76 05 52 020	47,5x28	18,3/4x11



Portamacedonia Square

Square yogurt/fruit-salad holder without lid
 Porte-salade de fruits/yogourt sans couvercle Square
 Joghurt/Obstsalatbehälter ohne Deckel Square
 Porta yogur/ensalada de frutas refrigerado sin tapa Square

	Cm	In
V76 05 52 017	24x24	6,7/8x6,7/8
Con coperchio - with lid		

V76 05 52 007	24x24	6,7/8x6,7/8
Senza coperchio - without lid		

**Coperchio metacrilato c/pomolo Square**

Acrylic lid with knob Square
 Couvercle acrylique avec pommeau Square
 Deckel aus Acryl mit Knopf Square
 Tapa acrílica con perilla Square

310 12 15 797

**Ciotola in vetro**

Glass bowl
 Bol en verre
 Glasschale
 Bol de vidrio

	ø Cm	ø In
310 08 42 527	23	9

**Disco copri eutettici**

Ice pack cover
 Disc pour blocs réfrigérants
 Disco para acumuladores de frío
 Kühllakku Scheibe

	ø Cm	ø In
Z76 60 52 007	24	9,1/2

**Eutettici rettangolari**

Ice packs
 Blocs réfrigérants
 Abdeckungscheibe für Kühllakku
 Acumuladores de frío rectangulares

V77 12 95 M00

Contenitore in metallo porta macedonia /eutettico Square

Square metal fruit salad holder 24x24 Cm w/o ice pack
 Conteneur en métal pour salade de fruits sans bloc réfrigérant Square
 Metalbehälter ohne Kühllakku Square
 Porta ensalada de frutas en metal Square sin acumuladore de frío

Z76 20 52 007



Portayogurt/marmellata refrigerato Square

Square thermal yogurt/jam holder for pitcher
 Rafrâchisseur yaourt/confiture Square
 Joghurt/Marmeladebehälter, gekühlt Square
 Portayogur/mermelada refrigerado Square

	∅ Cm	∅ In
V76 05 52 014	15	6

Con coperchio - with lid

V76 05 52 004	15	6
---------------	----	---

Senza coperchio - without lid



Coperchio porta yogurt c/pomolo Square

Square lid with knob for yogurt holder
 Couvercle sans pomole pour porte-yaourt Square
 Deckel für Joghurtbehälter Square
 Tapa para portayogur sin perilla Square

	∅ Cm	∅ In
Z76 01 52 004	4	1,1/2



Ciotola in vetro

Glass bowl
 Bol en verre
 Glasschale
 Bol en vidrio

	∅ Cm	∅ In	Lt	Oz
V76 08 52 004	15	6	0,5	17



Disco copri eutettici

Ice pack cover
 Disc pour blocs réfrigérants
 Kühlakku Scheibe
 Disco para acumuladores de frío

	∅ Cm	∅ In
Z76 60 52 005	15	6



Eutettici tondi

Round ice packs
 Blocs réfrigérants ronds
 Abdeckungscheibe für Kühlakku
 Acumuladores de frío rectangulares

	∅ Cm	∅ In
V77 12 95 T01	14,5	5,3/4



Contenitore in metallo porta caraffe/yogurt s/eutettico Square

Square pitcher/yogurt holder w/without ice pack
 Conteneur en métal pour carafes/yaourt sans bloc réfrigérant Square
 Metalbehälter ohne Kühlakku Square
 Portayogur/jarra sin acumulador de frío Square

	Cm	H Cm	In	H In
Z76 20 52 004	17,5x17,5	7	6,7/8x6,7	3,3/4



Portacaraffa con coperchio refrigerato Square

Square thermal pitcher holder with lid
 Porte-carafe avec couvercle réfrigérant Square
 Karaffenträger mit Deckel, gekühlt Square
 Soporte refrigerado para jarra con tapa Square

	Lt	Oz
V76 05 52 005	1,5	50

Con coperchio-with lid

V76 05 52 006	1,5	50
---------------	-----	----

Senza coperchio-without lid

**Coperchio caraffa in acciaio per brocca**

St. Steel lid for juice pitcher
 Couvercle en acier pour carafe
 Edelstahl Deckel für Karaffe
 Tapa en acero para jarra

	∅ Cm	∅ In
Z76 01 52 005	10	4

**Caraffa vetro**

Glass pitcher
 Carafe en verre
 Saftkanne
 Jarra de zumo

	Lt	Oz
V76 08 52 009	1,5	50

Senza coperchio-without lid

V76 08 52 005	1,5	50
---------------	-----	----

Con coperchio-with lid

**Disco copri eutettici**

Ice pack cover
 Disc pour blocs réfrigérants
 Kühlakkus Scheibe
 Disco para acumuladores de frío

	∅ Cm	∅ In
Z76 60 52 005	15	6

**Eutettici tondi**

Round ice packs
 Blocs réfrigérants ronds
 Kühlakkus rund
 Acumuladores de frío rectangulares

	∅ Cm	∅ In
V77 12 95 T01	14,5	5,3/4

**Contenitore in metallo porta caraffe/yogurt s/eutettico Square**

Square pitcher/yogurt holder w/o ice pack
 Conteneur en métal pour carafes/yaourt sans bloc réfrigérant Square
 Metalbehälter ohne Kühlakkus Square
 Portayogur/jarra sin acumulador de frío Square

	Cm	H Cm	In	H In
Z76 20 52 004	17,5x17,5	7,5	6,7/8x6,7	3



Portacaraffe con sistema refrigerante

Thermal pitcher 4-pc set
 Rafrâchisseur à 4 carafes
 Thermo-Karaffenhälter 4 Stck.
 Enfriador para 4 jarras

Inox 18/10 - St. Steel

	Cm	H Cm	In	H In
V76 05 52 021	24x24	7,5	9,1/2x9,1/2	3

Caraffe non incluse - Water jugs not included



Caraffa acqua con coperchio basculante

Water glass pitcher with smart lid
 Carafe en verre avec couvercle basculant
 Wasserkaraffe
 Jarra de vidrio con tapa basculante

	Lt	Oz
● V76 08 52 007	1	35
● V76 08 52 007 35	1	35
● V76 08 52 007 07	1	35

Rinfresca caraffe con sistema refrigerante

Thermal pitcher
 Rafrâichisseur à carafes
 Thermo-Karaffenhalter
 Enfriador de botallas

Inox 18/10 - St. Steel

	ø Mm	H Cm	ø In	H In
V76 055 20 23	135	5	5,3/8	2

con eutettico - with ice pack
 caraffa esclusa - without pitcher

**Eutettico per rinfresca caraffe**

Ice pack for thermal pitcher
 Bloc réfrigérant pour rafraîchisseur à carafes
 Kühlelemente für Thermo-Karaffenhalter
 Acumulador de frío para enfriador de botallas

Polietilene - Polyethylene

	ø Mm	H Cm	ø In	H In
V77 12 95 T02	75	2,5	3	1

**Corpo per porta caraffa**

Container for thermal pitcher
 Conteneur pour rafraîchisseur à carafes
 Behälter für Thermo-Karaffenhalter
 Contenedor para enfriador de botallas

Polietilene - Polyethylene

	ø Mm	H Cm	ø In	H In
Z76 20 52 023	135	5	5,3/8	2



Contenitore alto per struttura piramidale

Container for pyramid buffet system
Conteneur haut pour structure pyramidale
Behälter für pyramidal Gestell
Contenedor alto para estructura piramidal

	Cm	H Cm	In	H In
V76 05 23 006	7x9,5	6	2,3/4x3,3/4	2,3/8



Cucchiaino appetizer tondo

Appetizer curved spoon
Cuillère de mise en bouche ronde pliée
Appetizer - rund gebogener Löffel
Cuchara aperitivo redonda plegada

Inox 18/10 - St. Steel

	Cm	In
903 05 81 APC	140	5,1/2



Ciotola porcellana quadra

Porcelain square bowl
Bol carré en porcelaine
Porzellanschale, viereckig
Bol cuadrado en porcelana

	Cm	In
V86 21 42 CQ7	7x7	2,3/4x2,3/4



Bicchieri

Glass
Verre
Glas
Vaso

	ø Cm	H Cm	ø In	H In
V86 08 42 BBA	5,5	7	2,1/8	2,3/4



Struttura piramidale

completa di 5 ripiani e 3 contenitori alti.

Pyramid buffet system including 5 bases and 3 containers
Structure pyramidale complète avec 5 bases e 3 conteneurs
Pyramidal Gestell komplet bestehend von 5 Fächer und 3 hoch Behälter
Estructura piramidal completa con 5 bases y 3 contenedores

	Cm	H Cm	In	H In
V76 05 42 006	29,5x36,5	50	11,3/4x14,1/2	19,3/4



Piano rettangolare per struttura piramidale

Rectangular base for pyramid buffet system
Plan rectangulaire pour structure pyramidale
Rechteckig Fach für pyramidal Gestell
Base rectangular para estructura piramidal

	Cm	In
V76 05 23 005	29,5x7	11,5/8x2,3/4





Un oggetto **elegante e contemporaneo**, adatto a ogni tipo di buffet: grazie al design unico e innovativo.

I materiali usati sono di **alto livello qualitativo** - acciaio Inox 18/10 e metacrilato - e rendono il distributore un oggetto pregiato.

MADE IN ITALY

La **tecnologia semplice**, ma al tempo stesso funzionale, permette di erogare dosi da 8gr (0.28 oz) di prodotto, riducendo gli sprechi ed eliminando le monoporzioni da 25gr (0.88 oz).

Questo consente un risparmio di prodotto e la riduzione dei rifiuti

nel rispetto dell'ambiente. Inoltre è ideale per servire miele e marmellate di produzione artigianale, per fornire un prodotto di alto livello e che soddisfi anche i clienti più esigenti.

Un ottimo modo per arricchire l'esperienza della colazione, mantenendo **ordinato e pulito** il buffet.

Utilizzabile con prodotti erogabili semisolidi, come confetture, marmellate - pure con piccoli frammenti di frutta - e creme, ma anche con miele, sciroppi e salse di analoga consistenza.

Jambee è l'ideale per **ogni struttura ricettiva**: alberghi, pasticcerie, bar e ristoranti.



An **elegant and modern** object for all buffets, thanks to its unique and innovative design.

The materials used are **high quality** – 18/10 stainless steel and methacrylate – which makes the dispenser a fine object.

MADE IN ITALY

Its **simple technology**, though functional, allows to dispense 8 gr (0.28 oz) product doses, to reduce waste and get rid of 25 gr (0.88 oz) single dose jars.

That allows, as well, to save on product and reduce waste, respecting the environment.

Moreover, it is the ideal to dispense honey and homemade jams, in order to supply for a high-end product, capable of meeting even the most demanding customers' needs.

The best way to make the most of the breakfast experience, keeping the buffet **tidy and clean**.

It can be used with dispensable semisolid products like preserves, marmalades – even with small fruit pieces in them –, creams and honey, syrups and sauces as well, which have the same consistency. Jambee is the ideal for **any accommodation facility**: hotels, pastry shops, bars and restaurants.

**Pistone con coperchio**

Piston with lid

Piston avec couvercle

Kolben mit Deckel

Pistón con tapa

Inox 18/10, Metacrilato e PP - St. Steel, Methacrylate and PP

Lt

Z77 9852 DMA 0,7**Z77 9852 DMA1** 1**Contentitore**

Container

Conteneur

Behälter

Contenedor

Metacrilato - Methacrylate

Lt

Z77 2052 DMA 0,7**Z77 2052 DMA1** 1**Tappo**

Cap

Capsule

Stöpsel

Tapón

Metacrilato - Methacrylate**Z77 1352 DMA****Contentitore completo**

Complete container

Conteneur complet

Komplett Behälter

Contenedor completo

Metacrilato - Methacrylate

Lt

Z77 9952 DMA 0,7**Z77 9952 DMA1** 1**Targhetta porta etichetta**

Label plate

Plaque porte-étiquette

Schild Etikettenhalter

Placa porta etiqueta

Metacrilato - Methacrylate**Z77 5752 DMA****Targhetta porta etichetta**

Label plate

Plaque porte-étiquette

Schild Etikettenhalter

Placa porta etiqueta

Metacrilato - Methacrylate**Z77 5752 DMA1**

Jambee

Jambee
Jambee
Jambee
Jambee

Acciaio Inox 18/10 - St. Steel

	Lt	Oz	Cm	In
V77 0552 DMB	0,7	24	12,5x34,5 H Min 44,5 H Max 58	5x13,5/8 H Min 17,1/2 H Max 22,7/8
V77 0552 DMC	1	35	12,5x34,5 H Min 48 H Max 71,5	5x13,5/8 H Min 18,3/4 H Max 28,1/8



Erogatore a siringa

Syringe nozzle
Embout seringue
AusgieBerspritze
Boquilla jeringa

Inox 18/10 - St. Steel

Z77 4652 DMA



Erogatore standard

Standard nozzle
Embout standard
Standard AusgieBer
Boquilla estandar

Inox 18/10 - St. Steel

Z77 4552 DMA

BUFFET IMPERIAL





Portaformaggi/affettati rettangolare completo

Rectangular cheese dish

Plateau fromage-charcuterie rectangulaire

Käse/Wurstwarenplatte - rechteckig

Quesera rectangular

	Cm	H Cm	In	H In
V77 05 54 G11	53x32,5	18	20,7/8x12,3/4	7

**Coperchio a bascula trasparente**

Transparent rolltop cover

Cloche basculante transparente

Rolltophaube

Campana rolltop transparente

	Cm	In
V77 12 15 G11	47x27	18,1/2x10,5/8

**Vassoio gastronorm**

Gastronorm tray

Plateau gastronorm

Gastronorm Platte

Bandeja gastronorm

	Cm	In
V01 05 23 G11	53x32,5	20,7/8x12,3/4

**Tagliere rettangolare**

Rectangular cutting board

Planche rectangulaire

Rechteckig-Schneidebrett

Tabla para cortar rectangular

Polietilene

	Cm	In	Sp. Mm	Th. In
V77 12 71 G11	47x27	18,1/2x10,5/8	1,5	0,5/8

Portaformaggi/affettati tondo completo

Round cheese dish

Plateau fromage-charcuterie rond

Käse/Wurstwarenplatte - rund

Quesera redonda

	ø Cm	H Cm	ø In	H In
V77 05 54 T46	46	24,5	18,1/8	9,5/8



Coperchio a bascula tondo trasparente

Transparent round rolltop cover

Cloche basculante ronde transparente

Rolltophaube - rund

Campana rolltop redonda transparente

	ø Cm	ø In
V77 12 15 T46	41	16,1/8



Vassoio tondo bar

Round bar tray

Plateau rond bar

Platte - rund

Bandeja redonda bar

	ø Cm	ø In
V01 05 23 T46	46 Cm	18,1/8



Tagliere tondo

Round cutting board

Planche ronde

Schneidebrett - rund

Tabla para cortar redonda

Polietilene

	Cm	In	Sp. Mm	Th. In
V77 12 71 T46	41	16,1/8	2	0,3/4

Portaformaggi/affettati rettangolare completo refrigerato con base in acciaio

Thermal rectangular cheese dish

Plateau fromage-charcuterie rectangulaire réfrigéré

Käse/Wurstwarenplatte - rechteckig

Quesera rectangular refrigerante

	Cm	H Cm	In	H In
V77 05 54 G11 R	53x32,5	19	20,7/8x12,3/4	7,1/2

**Coperchio a bascula rettangolare trasparente**

Transparent rectangular rolltop cover

Cloche basculante rectangulaire transparente

Rolltophaube-rechteckig

Campana rectangular transparente

	Cm	In
V77 12 15 G11	47x27	18,1/2x10,5/8

**Tagliere rettangolare**

Rectangular cutting board

Planche à découper rectangulaire

Rechteckiges Schneidebrett

Tabla de cortar rectangular

Polietilene

	Cm	In	Sp. Mm	Th. In
V77 12 71 G11	47x27	18,1/2x10,5/8	1,5	0,5/8

**Bacinella rettangolare**

Rectangular pan

Cuvette rectangulaire

Schüssel - rechteckig

Cubeta rectangular

	Cm	H Cm	In	H In
V77 05 14 G11	53x32,5	3,5	20,7/8x12,3/4	1,1/8

**8 Eutettici rettangolari**

8 Ice packs

8 Blocs réfrigérants

8 Kühlakkus

8 Acumuladores de frío rectangulares

V77 12 95 P00

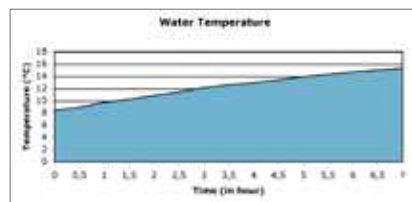

Temperatura ambiente
External temperature 19,6°

Temperatura acqua
Water temperature 18,9°

Mezzo refrigerante
Cooler system 8 eutettici ghiaccio piccoli
8 small ice pack

Portaformaggi/affettati tondo completo refrigerato con base in acciaio

Thermal round cheese dish

Plateau fromage-charcuterie rond réfrigéré

Käse/Wurstwarenplatte - rund

Quesera redonda refrigerante

	Cm	H Cm	In	H In
V77 05 54 T46 R	46	27,5	18,1/8	10,7/8



Coperchio a bascula tondo trasparente

Transparent round rolltop cover

Cloche basculante ronde transparente

Rolltophaube - rund

Campana redonda transparente

	∅ Cm	∅ In
V77 12 15 T46	41	16,1/8



Tagliere tondo

Round cutting board

Planche ronde

Schneidebrett - rund

Tabla para cortar redonda

Polietilene

	Cm	In	Sp. Mm	Th. In
V77 12 71 T46	41	16,1/8	2	0,3/4



Bacinella tonda

Round pan

Cuvette ronde

Schüssel - rund

Cubeta redonda

	∅ Cm	H Cm	∅ In	H In
V77 05 14 T46	46	5	18,1/8	2



4 Eutettici rettangolari

4 Ice packs

4 Blocs réfrigérants

4 Kühlakkus

4 Acumuladores de frío rectangular

V77 12 95 G00

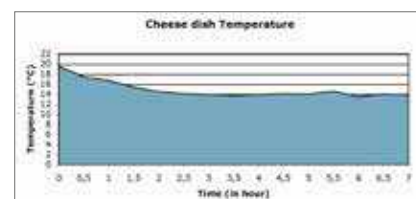

Temperatura ambiente
External temperature

20,9°

Temperatura acqua
Water temperature

19,5°

Mezzo refrigerante
Cooler system

4 eutettici ghiaccio piccoli
4 small ice pack

Scaldavivande rettangolare con coperchio rotante

Rectangular rolltop chafing dish

Chafing dish rectangulaire avec couvercle pivotant

Chafing Dish - rechteckig mit Rolltophaube

Calientaplatos rectangular con campana

	GN	Cm	H Cm	In	H In
V77 05 52 CHR	1/1	65,5x48	44	25,3/4x19	17,3/8

Con:

Coperchio rotante a scomparsa

Portavivande 1/1 Gastronorm

2 bruciatori per pasta - combustibile

Predisposto per piastra elettrica

With:

Rolltop

1/1 gastronorm food pan

2 solid fuel burners.

Electric heating element

(available as optional)

**Fornelletto per scaldavivande**

Chafing-dish burner

Porte-brûleur pour chafing dish

Brennstoffhalter für Chafing Dish

Contenedor de combustible para chafing dish

V77 05 52 FDC

**Piastra elettrica per scaldavivande**

Heating element for chafing-dishes

Plaque électrique réchauffeur chafing dish

Elektro - Heizelement für Chafing Dish

Plancha eléctrica para calienta platos

	V	W	Hz
V77 05 52 PCR	220	500	50

V77 05 52 PCR1 230 250

Con regolatore With power regulator

Con fornelletti

Whit burners

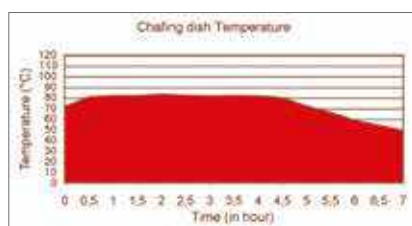

Temperatura ambiente External temperature	20,3°
Temperatura acqua Water temperature	94°
Quantità acqua inserita Quantity of water added	6 Lt.
Fonte di calore Heat source	2 fornelletti a fiamma 2 burners

Con piastra elettrica

Whit heating element

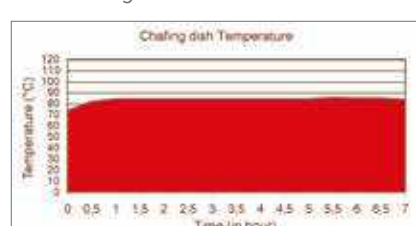

Temperatura ambiente External temperature	20,3°
Temperatura acqua Water temperature	94°
Quantità acqua inserita Quantity of water added	6 Lt.
Fonte di calore Heat source	piastra elettrica heating element

Scaldavivande tondo con coperchio rotante

Round rolltop chafing dish
Chafing dish rond avec couvercle pivotant
Chafing Dish - rund mit Rolltophaube
Calientaplatos redondo con campana

	∅ Cm	H Cm	∅ In	H In
V77 05 52 CHT	50	46	15,3/4	18,1/8

Con:

Coperchio rotante a scomparsa
Portavivande ∅ 40 Cm
1 bruciatore per pasta - combustibile
Predisposto per piastra elettrica

With:

Rolltop
Food pan ∅ 40 Cm
Solid fuel burners.
Electric heating element
(available as optional)



Fornelletto per scaldavivande

Chafing-dish burner
Porte-bruleur pour chafing dish
Brennstoffhalter für Chafing Dish
Contenedor de combustible para chafing dish

V77 05 52 FDC



Piastra elettrica per scaldavivande

Heating element for chafing-dishes
Plaque électrique réchauffeur chafing dish
Elektro - Heizelement für Chafing Dish
Plancha eléctrica para calienta platos

	V	W	Hz
V77 05 52 PCT	220	500	50

V77 05 52 PCT1 230 250
Con regolatore With power regulator

Con fornelli Whit burners

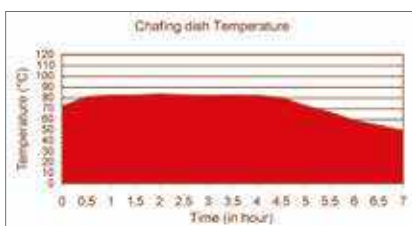

Temperatura ambiente External temperature	20,3°
Temperatura acqua Water temperature	94°
Quantità acqua inserita Quantity of water added	6 Lt.
Fonte di calore Heat source	2 fornelli a fiamma 2 burners

Con piastra elettrica Whit heating element

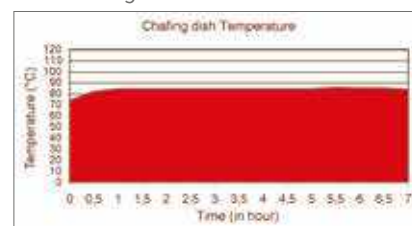

Temperatura ambiente External temperature	20,3°
Temperatura acqua Water temperature	94°
Quantità acqua inserita Quantity of water added	6 Lt.
Fonte di calore Heat source	piastra elettrica heating element

Portavivande in porcellana

Food pan, porcelain

Bac en porcelaine

Porzellanbehälter

Cubeta de porcelana

	GN	Cm	In
V01 21 52 G11B	1/1	53x32,5x6,5	20,7/8x12,3/4x2,1/2
V01 21 52 G23B	2/3	35,3x32,5x6,5	13,3/4x12,3/4x2,1/2
V01 21 52 G12B	1/2	26,5x32,5x6,5	10,3/8x12,3/4x2,1/2
V01 21 52 G13B	1/3	17,6x32,5x6,5	6,7/8x12,3/4x2,1/2

**Portavivande tondo in porcellana**

Round food pan, porcelain

Bac rond en porcelaine

Porzellanbehälter, rund

Cubeta redonda de porcelana

	ø Cm	ø In
V01 21 52 T40	40	15,3/4

**Inserto scaldavivande tondo in porcellana**

Food pan half round chafing dish, porcelain with divider

Bac double en porcelaine pour chafing dish rond

Porzellanersatz, 2tlg für Chafing Dish

Cubeta avec separation de porcelana para chafing dish redondo

	ø Cm	ø In
V01 21 71 T12 (1 pz.)	40 Cm	15,3/4

**Set zuppiere per scaldavivande tondo**

Soup tureen set for Cm. 40 round chafing dish

Set de soupières pour chafing dish rond

Suppenschüssel für Chafing Dish rund

Set de soperas para chafing dish redondo

	ø Cm	ø In	Lt	Oz
V77 05 52 ACT	40	15,3/4	4,2	142

**Set minstre per scaldavivande rettangolare**

Soup tureen set for rectangular chafing dish

Set de soupières pour chafing dish rectangulaire

Suppenschüssel für Chafing Dish rechteckig

Set de soperas para chafing dish rectangular

	GN	Lt	Oz
V77 05 52 ACR	1/1	4,2	142



Porta cereali girevole a 3 comparti*

Triple rotating cereal holder
 Distributeur céréales pivotant à 3 compartiments
 Büffet-Ständer - drehbar mit 3 Glasschalen
 Dipensador de cereales giratorio 3 sectores

	∅ Cm	∅ In
V77 05 52 CER 3	42	16,1/2



*Sono escluse le ciotole in vetro
 *Without glass bowls

Porta cereali girevole a 6 comparti*

6-dish rotating cereal holder
 Distributeur céréales pivotant à 6 compartiments
 Büffet-Ständer - drehbar mit 6 Glasschalen
 Dipensador de cereales giratorio 6 sectores

	∅ Cm	∅ In
V77 05 52 CER	42	16,1/2 in



Ciotola in vetro

Glass bowl
 Bol en verre
 Glasschale
 Bol de vidrio

	∅ Cm	∅ In	Lt	Oz
310 08 42 527	23	9	1,3	60



Coperchio in metacrilato

Acrylic lid
 Couvercle acrylique
 Deckel aus Metakryl
 Tapa acrílica

	∅ Cm	∅ In
310 12 15 795	23	9

Con pomolo in metacrilato - With acrylic knob

	∅ Cm	∅ In
310 12 15 790	23	9

Con pomolo in acciaio Inox - With St. Steel knob



Distributore cereali girevole a 3 comparti con base in acciaio

Triple rotating cereal dispenser with stainless steel base

Distributeur céréales pivotant à 3 compartiments avec base en acier Inoxidable

3-Müslidispenser-drehbar mit Stahlboden

Dispensador de cereales giratorio 3 sectores con base de acero Inoxidable

	ø Cm	H Cm	ø In	H In	Lt	Oz
V77 05 52 CD6	42	60	16,1/2	23,5/8	3 (x3)	101 (x3)

Con:

Contentore removibile

Pomolo in metallo

Spazzola interna

Girandola dosatrice

With:

Removable container

Metal knob

Inner brush

Doser handle

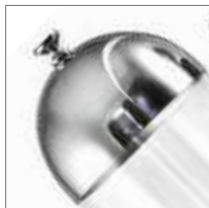
**Contentore removibile**

Consente di riempirlo e pulirlo facilmente

Removable container

It allows to be filled in and cleaned easily

**Spazzola interna**

non rompe i cereali

Inner brush

that does not break cereals

**Dettaglio pomolo in metallo**

Detail of metal knob

**Girandola dosatrice**

Doser handle



Distributore cereali singolo con base in acciaio

Single cereal dispenser with stainless steel base

Distributeur céréales individuel avec base en acier Inoxidable

Müslidispenser mit Stahlboden

Dispensador de cereales individual con base de acero Inoxidable

	Cm	H Cm	In	H In	Lt	Oz
V77 05 52 CD4	31x21	60	12,1/4x8,1/4	23,5/8	3	101



Distributore cereali a 2 comparti con base in acciaio

Double cereal dispenser with stainless steel base

Distributeur céréales à 2 compartiments avec base en acier Inoxidable

2-Müslidispenser mit Stahlboden

Dispensador de cereales 2 sectores con base de acero Inoxidable

	Cm	H Cm	In	H In	Lt	Oz
V77 05 52 CD5	37,5x24,5	60	14,3/4x9,5/8	23,5/8	3 (x2)	101 (x2)



Portayogurt

Yogurt tray
Plateau porte-yogourt
Joghurtplatte
Bandeja yogur

	ø Cm	ø In	H Cm	H In
V77 05 52 T46	46	18,1/8	5	2



Portaburro/crostacei

Butter tray
Plateau porte-beurre/crustacés
Butter/Krustazeenplatte
Bandeja mantequilla

	ø Cm	ø In	H Cm	H In
V77 05 09 T32	32	12,5/8	5	2
V77 05 09 T46	46	18,1/8	5	2



Tagliere per pane con base acciaio

Bread cutting board
Planche à découper à pain
Tabla de cortar pan
Brotschneidebrett

	Cm	H Cm	In	H In
V01 05 54 004	53x32,5	3,5	20,7/8x12,3/4	1,1/8



Cestino portabrioche tondo con cloche basculante

Round croissant basket with rolltop cover

Corbeille ronde à viennoiseries avec cloche basculante

Büffetkorb - rund mit Rolltophaube

Cesta de buffet redonda con campana roll top

Rattan

	ø Cm	ø In	HCm	H In
V77 04 52 T44	44	17,3/8	35	13,3/4



Coperchio a bascula tondo trasparente

Transparent round rolltop cover

Cloche basculante ronde transparente

Rolltophaube - rund

Campana redonda roll top transparente

	ø Cm	ø In
V77 12 15 T46	41	16,1/8



Cestino rattan

Rattan basket

Corbeille rottin

Rattankorb

Cesta ratán

	ø Cm	ø In
V77 04 24 T44	41	17,3/8

Interno rotondo in adatto al contatto con gli alimenti

Inside base for rattan round croissant basket. Suitable for food contact

Revêtements intérieurs, apte au contacte alimentaire

Innenverkleidung Lebensmittel geeignet

Forro interior, apto para alimentos

Polistirene

	ø Cm	ø In	H Cm	H In
Z77 46 52 T44	41	14,1/8	11	4,3/8

Cestino portabrioches rettangolare con cloche basculante

Rattan rectangular croissant basket with rolltop cover
 Corbeille rectangulaire à viennoiseries avec cloche basculante
 Büffetkorb - rechteckig mit Rolltophaube
 Cesta de buffet rectangular con campana roll top

Rattan

	Cm	In	H Cm	H In
V77 04 52 R50	50x29,5	19,3/4x11,5/8	29,5	11,5/8



Coperchio a bascula rettangolare trasparente

Transparent rectangular rolltop cover
 Cloche basculante rectangulaire transparente
 Rolltophaube - rechteckig
 Campana roll top rectangular transparente

	Cm	In
V77 12 15 G36	37x21	14,1/2x8,1/4
V77 12 15 G11	47x27	18,1/2x10,5/8



Cestino rattan

Rattan basket
 Corbeille rottin
 Rattankorb
 Cesta ratán

	Cm	In
V77 04 24 R39	38,5x23	15,1/8x9
V77 04 24 R50	50x29,5	19,3/4x11,5/8

Interno rettangolare adatto al contatto con gli alimenti

Inside base for rattan rectangular croissant basket. Suitable for food contact
 Revêtements intérieurs, apte au contacte alimentaire
 Innenverkleidung Lebensmittel geeignet
 Forro interior para cestas de buffet, apto para alimentos

Polistirene

	∅ Cm	∅ In	H Cm	H In
Z77 46 52 R50	50x27	15x7,5/8	11	4,3/8

Coperchio in metacrilato

Acrylic lid
Couvercle acrylique
Deckel Acryl
Tapa acrílica

	∅ Cm	∅ In
310 12 15 795	23	9

Con pomolo in metacrilato - With acrylic knob

310 12 15 790	23	9
----------------------	-----------	----------

Con pomolo in acciaio Inox - With St. Steel knob

**Ciotola in vetro**

Glass bowl
Bol en verre
Glasschale
Bol de vidrio

	∅ Cm	∅ In	HCm	H In
310 08 42 527	23	9	10,5	4,1/8



**Rinfrescamacedonia/yogurt
con contenitore ghiaccio esterno con coperchio**

Fruit-salad/yogurt cooler with outer ice container and lid

Rafraîchisseur salade de fruits/yogourt avec récipient à glace externe et couvercle

Joghurt/Obstsalatbehälter mit Eisbehälter außen und mit Deckel

Portaensalada de frutas/yogur refrigerado con recipiente para hielo externo y tapa

Metacrilato

	∅ Int. Cm	∅ Int. In	∅ est. Cm	∅ est. In
V77 05 43 YOG 2	23	9	26	10,1/4



**Rinfrescamacedonia/yogurt
con contenitore ghiaccio esterno in acciaio con coperchio**

Fruit-salad/yogurt cooler with outer ice container and lid

Rafraîchisseur salade de fruits/yogourt avec récipient à glace externe avec couvercle

Joghurt/Obstsalatbehälter mit Edelstahl - Eisbehälter außen mit Deckel

Portaensalada de frutas/yogur refrigerado con recipiente para hielo externo con tapa

Acciaio

	∅ Int. Cm	∅ Int. In	∅ est. Cm	∅ est. In
V77 05 43 YOG	23	9	28	11



Distributore caffè con rubinetto in metallo

Coffee urn

Distributeur café

Kaffeedispenser

Dispensador de café

	Ø Cm	Ø In	H Cm	H In	Lt	Oz
V77 05 52 DCA	21	8,4	54	21,1/4	7	237
V77 05 52 DCA 1	21	8,4	62	24,3/8	10	350

**Rubinetto in metallo**

Metal tap

Robinet en métal

Metallhahn

Grifo de metal

Z77 18 52 OTT

**Piastra elettrica per distributore caffè**

Heating element for coffee urns

Plaque électrique pour distributeur de café

Elektro-Heizelement für Kaffeedispenser

Plancha eléctrica para dispensadores de café

	Ø Cm	Ø In
V77 05 52 PDC	14	5,1/2

**Fornelletto per scaldavivande/distributore caffè**

Burner for chafing dishes-coffee urns

Porte bruleur pour chafing dish et distributeur café

Brennstoffhalter für Chafing Dish und Kaffeedispenser

Contenedor de combustible para chafing dish - dispensadores de café

V77 05 52 FDC

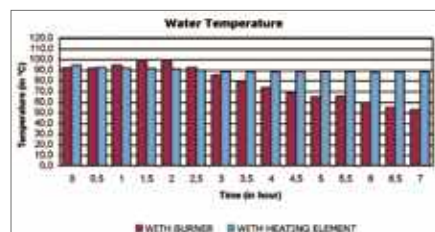
Temperatura ambiente
External temperature

20,0°

Temperatura acqua
Water temperature

92,5°/98,8°

Quantità acqua inserita
Quantity of water added

8 Lt

Distributore succhi

Juice dispenser
Distributeur jus
Saftdispenser
Dispensador de zumo



Con rubinetto in metallo

With metal tap
Avec robinet en métal
Mit Metallhahn
Con grifo de metal

	Cm	H Cm	Lt
V77 05 52 DSM	25x35	66	8
	In	H In	Oz
	9,7/8x13,3/4	26	270

Rubinetto in metallo

Metal tap
Robinet en métal
Metal- Holzständer
Grifo de metal

Z77 18 52 OTT



Con rubinetto in plastica

With plastic tap
Avec robinet en plastique
Mit Kunststoffhahn
Con grifo de plástico

	Cm	H Cm	Lt
V77 05 52 DSU	25x35	66	8
	In	H In	Oz
	9,7/8x13,3/4	26	270

Rubinetto in plastica nero

Black plastic tap
Robinet en plastique noir
Plastikhahn, Schwarz
Grifo de plástico negro

Z77 18 52 POL



Contentitore trasparente

Transparent container
Récipient transparent
Durchsichtbare Behälter
Contenedor transparente

	Lt	Oz
Z77 63 52 000	8	270



Eutettici tondi

Round ice packs
Blocs réfrigérants
Kühlakkus
Acumuladores de frío rectangulares

V77 12 95 T01



Supporto refrigerato per caraffe succhi con vassoio portabicchieri*

Thermal stand for juice pitchers with glasses tray*

Support réfrigéré pour carafes jus avec plateau porte-verres

Saftkaraffenständer gekühlt mit Gläserständer

Soporte refrigerante para jarras zumo con bandeja para vasos

	ø Cm	ø In	H Cm	H In
V77 05 52 SUC			67	26,3/8
Base	41,5	16,3/8		
Alzata - Holder	38,5	15,1/8		
Sede caraffa - Pitcher seat	16,4	6,1/2		

Supporto refrigerato per caraffe succhi*

Thermal stand for juice* pitchers

Support réfrigéré pour carafes jus

Saftkaraffenständer gekühlt

Soporte refrigerante para jarras zumo

	ø Cm	ø In	H Cm	H In
V77 05 52 SUS			36	14,1/8
Base	41,5	16,3/8		
Sede caraffa - Pitcher seat	16,4	6,1/2		



Disco coprietettici per supporto refrigerante per caraffe

Plate for thermal stand for juice pitchers (to cover ice packs)

Plaque couvre-blocs réfrigérants pour support réfrigéré pour carafes

Deckel für Kühlelemente zum Karaffenbehälter

Placa cubre acumuladores de frío para soporte refrigerante para jarras

	ø Cm	ø In
PRV 1A SU CAD S0	41	16,1/8

*Sono escluse le caraffe in vetro

*Without pitchers

Caraffa succhi

Juice pitcher
Carafe jus
Saftkanne
Jarra zumo

	Lt	Oz
V76 08 52 005	1,5	51
Con coperchio in metallo - with metal lid 18/10		

V76 08 52 009	1,5	51
Senza coperchio - without lid		



Coperchio in acciaio 18/10

Stainless steel lid
Couvercle en acier 18/10
Deckel aus Edelstahl
Tapa de acero Inoxidable

Z76 01 52 005



Caraffa termica 18/10

Thermal beverage serve
Carafe thermos avec anse
Thermische Karaffe
Jarra térmica

	Cl	Oz
V01 05 08 T06	75	26
V01 05 08 T10	100	35
V01 05 08 T15	150	51
V01 05 08 T20	200	68



75 Cl - 26 Oz

Temperatura ambiente 19,6°
External temperature

Temperatura acqua 94°
Water temperature

Quantità acqua inserita 60 cl.
Quantity of water added

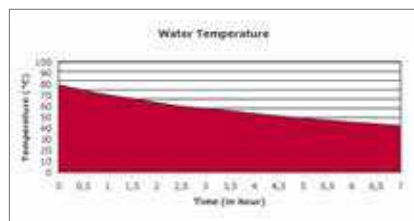

100 Cl - 35 Oz

Temperatura ambiente 19,6°
External temperature

Temperatura acqua 94°
Water temperature

Quantità acqua inserita 90 cl.
Quantity of water added

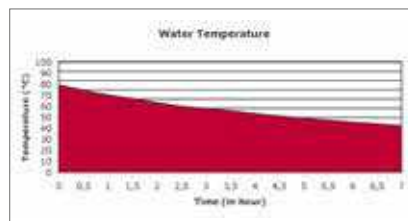

150/200 Cl - 53/70 Oz

Temperatura ambiente 20,9°
External temperature

Temperatura acqua 95°
Water temperature

Quantità acqua inserita 150 cl.
Quantity of water added

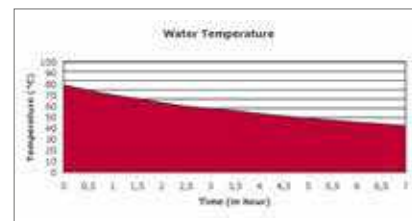

Alzata torta

Cake stand
Presentoir à gâteau
Tortenplatte
Soporte tarta

Inox 18/10 - St. Steel

	ø Cm	ø In	H Cm	H In
V01 05 42 022	22	8,5/8	9,5	3,3/4
V01 05 42 032	32	12,5/8	12,5	12,5
V01 05 42 042	42	16,1/2	16,5	6,1/2

**Alzata torta 3 piani**

3-tier cake stand
Présentoir à gâteau 3 étages
Kuchenständer 3-stufig
Soporte tarta con 3 pisos

Inox 18/10 - St. Steel

	ø Cm	ø In	H Cm	H In
V01 05 42 301	22/32/42	8,5/8-12,5/8-16,1/2	43,5	17,1/8

**Alzata frutta 3 piani**

3- tier fruit stand
Serviteur à fruits 3 étages
Obstständer 3-stufig
Frutero con 3 pisos

Inox 18/10 - St. Steel

	ø Cm	ø In	H Cm	H In
V77 05 42 326	22/29/36,5	8,5/4-11,3/8-14,3/8	44	17,3/8



Piatto torta con coperchio a bascula

Cake tray with roll top cover

Plateau à gâteaux avec cloche basculante

Kuchenplatte mit Rolltophaube

Plato para tartas con campana roll top

Inox 18/10 - St. Steel

	∅ Cm	∅ In
V76 05 42 003	38	15

Coperchio a bascula tondo trasparente

Transparent round rolltop cover

Cloche basculante ronde transparente

Rolltophaube - rund

Campana redonda transparente

SAN

	∅ Cm	∅ In
V76 12 15 T01	34	13,3/8



Alzata torta con coperchio a bascula

Cake stand with roll top cover

Présentoir à gâteaux avec cloche basculante

Kuchenplatte mit Schaukeldeckel

Soporte para tartas con campana roll top

Inox 18/10 - St. Steel

	∅ Cm	H Cm	∅ In	H In
V76 05 42 002	38	12,5+32	15	4,7/8 + 12,5/8



Vassoio torta con cupola in policarbonato Basic

Basic cake tray with acrylic dome cover

Plateau à gâteau avec cloche acrylique Basic

Kuckenplatte mit Akrylglocke Basic

Plato para tartas con campana acrílica Basic

Inox 18/10 - St. Steel

	∅ Cm	∅ In
V01 05 42 T32	31	12,1/4







TAVOLA • TABLE

Caffettiera Imperial

Imperial coffeepot
Cafetière Imperial
Kaffekanne Imperial
Cafetera Imperial

Inox 18/10 - St. Steel

	Cl	Oz
V01 05 01 035	35	12
V01 05 01 060	60	20
V01 05 01 100	100	35
V01 05 01 150	150	51
V01 05 01 200	200	68

**Teiera Imperial**

Imperial teapot
Théière Imperial
Teekanne Imperial
Tetera Imperial

Inox 18/10 - St. Steel

	Cl	Oz
V01 05 02 035	35	12
V01 05 02 060	60	20
V01 05 02 100	100	35
V01 05 02 130	130	44

**Lattiera Imperial**

Imperial milkpot
Pot à lait Imperial
Milchkanne Imperial
Lechera Imperial

Inox 18/10 - St. Steel

	Cl	Oz
V01 05 03 035	35	12
V01 05 03 060	60	20
V01 05 03 100	100	35

**Cremiera Imperial**

Imperial creamer
Crémier Imperial
Sahnekännchen Imperial
Jarrita de leche Imperial

Inox 18/10 - St. Steel

	Cl	Oz
V01 05 03 015	15	5



Caraffa termica Imperial

Imperial thermal beverage server
Carafe thermos Imperial
Thermoskanne Imperial
Jarra térmica Imperial

Inox 18/10 - St. Steel

	Cl	Oz
V01 05 08 T06	70	24
V01 05 08 T10	100	35
V01 05 08 T15	150	51
V01 05 08 T20	200	68

**Zuccheriera con maniglie Imperial**

Imperial sugar pot with lid and handles
Sucrier avec couvercle et poignées Imperial
Zuckerdose mit Griffen und Deckel Imperial
Azucarero con tapa y asas Imperial

Inox 18/10 - St. Steel

	Gr	Oz
V01 05 04 280	280	10

**Brocca acqua Imperial**

Imperial water pitcher
Carafe à eau Imperial
Wasserkrug Imperial
Jarra agua Imperial

Inox 18/10 - St. Steel

	Cl	Oz
V01 05 08 150	150	51
V01 05 08 200	200	68

**Zuccheriera Imperial**

Imperial sugar pot
Sucrier Imperial
Zuckerdose Imperial
Azucarero Imperial

Inox 18/10 - St. Steel

	Gr	Oz
V01 05 04 200	200	7



Portacannucce

Straw holder
 Porte-pailles
 Trinkhalmbehälter
 Portapajitas

Inox 18/10 - St. Steel

	∅ Cm	∅ In	H Cm	H In
V01 05 71 011	9	3,1/2	11	4,3/8

**Portacucchiaini**

Tea spoon holder
 Porte-cuillères à café
 Kaffeelöffelbecher
 Portacucharas café

Inox 18/10 - St. Steel

	∅ Cm	∅ In	H Cm	H In
V01 05 71 008	9	3,1/2	8	3,1/8

**Portabustine zucchero/the**

Rectangular sugar tray
 Sucrier rectangulaire
 Zucker-Behälter
 Azucarero rectangular

Inox 18/10 - St. Steel

	Cm	In	H Cm	H In
V78 05 04 PBU	10x6,5	4	3,5	1,3/8

**Passatè (colino tè) con coppetta**

Tea strainer
 Passoire à the
 Teesieb
 Colador de te

Inox 18/10 - St. Steel

	Cm	H Cm	In	H In
V01 05 91 001	9,5x5	3	3,3/4x2	1,1/8



Portauovo

Egg cup
Coquetier
Eierbecher
Huevera

Inox inossidabile - St. Steel

	∅ Cm	∅ In
V01 05 71 001	8,6	3,3/8

**Burriera piccola con coperchio**

Small butter dish with cover
Petit beurrier avec cloche
Klein Butterschale mit Deckel
Mantequera pequeña con tapa

Inox 18/10 - St. Steel

	∅ Cm	∅ In	
V01 05 09 107	7	2,3/4	
Z01 20 09 107	7	2,3/4	porcellana/porcelain

**Burriera con coperchio**

Butter dish with cover
Beurrier avec cloche
Butterschale mit Deckel
Mantequera con tapa

Inox 18/10 - St. Steel

	∅ Cm	∅ In	
V01 05 09 115	15	6	
Z01 20 09 115	15	6	porcellana/porcelain

**Portasalatini 3 scomparti**

3-tier snack/relish dish
Porte-biscuits salés à 3 compartiments
Salzgebäckschale, 3-tlg
Entremesera 3 sectores

Inox 18/10 - St. Steel

	∅ Cm	∅ In
V01 05 41 003	10,5	4,1/8



Portamarmellata per 4 confezioni

4-jar jam holder

Porte-confiture pour 4 pots

Konfitürenschaale, 4 tlg

Dispensador de mermelada para 4 botes

Inox 18/10 - St. Steel

	Cm	In
V76 05 09 001	18x45	7,1/8x1,3/4

**Portamarmellata 3 scomparti**

3-tier jam dish

Porte-confiture à 3 compartiments

Konfitürenschaale, 3 tlg

Dispensador de mermelada 3 sectores

Inox 18/10 - St. Steel

	∅ Cm	H Cm	∅ In	H In
V01 05 09 003	6	13	2,3/8	5,1/8

**Portamarmellata 6 scomparti**

6-tier jam dish

Porte-confiture à 6 compartiments

Konfitürenschaale, 6 tlg

Dispensador de mermelada 6 sectores

Inox 18/10 - St. Steel

	∅ Cm	H Cm	∅ In	H In
V01 05 09 006	6	17,5	2,3/8	6,7



Alzata pasticceria

Petit four stand
Support à pâtisserie
Petits-Fours-Ständer
Presentación pastelería

Inox 18/10 - St. Steel

	ø Cm	H Cm	ø In	H In
V01 05 41 012	12	11	4,3/4	4,3/8
V01 05 41 016	16	11,5	6,1/4	4,1/2
V01 05 41 022	22	12	8,5/8	4,3/4

**Alzata pasticceria 2 piani**

2-tier petit four stand
Support à pâtisserie à 2 étages
Petits-fours ständer 2-stufig
Presentación pastelería 2 pisos

Inox 18/10 - St. Steel

	ø Cm	H Cm	ø In	H In
V01 05 41 201	12/16	21,5	4,3/4-6,1/4	8,1/2
V01 05 41 202	16/22	22,5	6,1/4-8,5/8	8,7/8

**Alzata pasticceria 3 piani**

3-tier petit four stand
Support à pâtisserie à 3 étages
Kuchenständer 3-stufig
Presentación pastelería 3 pisos

Inox 18/10 - St. Steel

	ø Cm	H Cm	ø In	H In
V01 05 41 301	12/16/22	31	4,3/4-6,1/4-8,5/8	12,1/4



Servitore té/pasticceria

Afternoon tea stand
Stand thé/pâtisserie
Tee/Kuchenstander
Soporte para platos

Inox 18/10 - St. Steel

	ø Cm	H Cm	ø In	H In
V76 05 42 005	30	42	11,3/4	16,1/2
V76 05 42 004	25	40	9,7/8	15,3/4

**Alzata torta**

Cake stand
Surtout
Kuchenteller
Bandeja para tarta

Inox 18/10 - St. Steel

	ø Cm	H Cm	ø In	H In
CI 22600	32	3,5	12,5/8	1,3/8

**Alzata torta**

Cake stand
Presentoir à gâteau
Tortenplatte
Presentación tarta

Inox 18/10 - St. Steel

	ø Cm	H Cm	ø In	H In
V01 05 42 022	22	9,5	8,5/8	3,3/4
V01 05 42 032	32	12,5	12,5/8	12,5
V01 05 42 042	42	16,5	16,1/2	6,1/2

**Alzata torta 3 piani**

3-tier cake stand
Présentoir à gâteau 3 étages
Kuchenständer 3-stufig
Presentación tarta 3 pisos

Inox 18/10 - St. Steel

	ø Cm	H Cm	ø In	H In
V01 05 42 301	22/32/42	43,5	8,5/8-12,5/8-16,1/2	17,1/8



Alzata frutta

Fruit stand
 Serviteur à fruits
 Obststände
 Frutero

Inox 18/10 - St. Steel

	ø Cm	H Cm	ø In	H In
V77 05 42 126	22	12,5	8,5/8	5
V77 05 42 132	29	12,5	11,3/8	5
V77 05 42 138	36,5	12,5	14,3/8	5

**Alzata frutta 2 piani**

2-tier fruit stand
 Serviteur fruits à 2 étages
 Obststände 2-stufig
 Frutero 2 pisos

Inox 18/10 - St. Steel

	ø Cm	H Cm	ø In	H In
V77 05 42 226	22/29	22,5	8,5/8-11,3	8-8,7/8

**Alzata frutta 3 piani**

3- tier fruit stand
 Serviteur à fruits 3 étages
 Obststände 3-stufig
 Frutero 3 pisos

Inox 18/10 - St. Steel

	ø Cm	H Cm	ø In	H In
V77 05 42 326	22/29/36,5/44	8,5/4	11,3/8/14,3/8	17,3/8



Sottopiatto bordo inglese

Show plate with English decoration

Plat à présentation avec décoration anglaise

Platzteller mit englischer Dekoration

Plato de presentación con borde inglés

Inox 18/10 - St. Steel

	∅ Cm	∅ In
V01 05 25 132	31,5	12,3/8

**Sottopiatto liscio**

Show plate, plain

Plat à présentation simple

Platzteller

Plato de presentación liso

Inox 18/10 - St. Steel

	∅ Cm	∅ In
V01 05 25 032	31	12,1/4

**Sottobottiglia**

Bottle coaster

Sous bouteille

Flaschenuntersatz

Posabotella

Inox 18/10 - St. Steel

	∅ Cm	∅ In
V01 05 21 014	14	5,1/2

**Sottobicchiere**

Glass coaster

Sous verre

Untersatz

Posavasos

Inox 18/10 - St. Steel

	∅ Cm	∅ In
V01 05 21 011	11	4,3/8



Cestino pane rettangolare Square

Bread basket Square, rectangular
 Corbeille à pain rectangulaire Square
 Brotkorb Square, rechteckig
 Cesta pan rectangular Square

Inox 18/10 - St. Steel

	Cm	In
V76 05 24 002	20x12	7,7/8x4,3/4

**Cestino pane rettangolare Square**

Bread basket Square, rectangular
 Corbeille à pain rectangulaire Square
 Brotkorb Square, rechteckig
 Cesta pan rectangular Square

Inox 18/10 - St. Steel

	Cm	In
V76 05 24 003	27x12	10,5/8x4,3/4

**Panno per cestino pane c/velcro ecru**

Cloth for bread basket, beige
 Tissu pour corbeille à pain écru
 Sandfarbenes Tuch für Brotkorb
 Paño para cesta pan beige

	Cm	In
AS9 1CP	27	10,5/8

Cestino in filo agrumi

Citrus-fruit basket

Corbeille à agrumes

Obstkorb Edelstahl Draht für Zitrusfrüchte

Cesta cítricos

Inox 18/10 - St. Steel

	∅ Cm	H Cm	∅ In	H In
906 05 001	21 Cm	20	8,1/4	7,7/8

**Cestino frutta tondo in filo**

Fruit basket, round, wire

Corbeille a fruits ronde en fil d'acier

Drahtobstkorb, rund

Cesta frutas redonda en hilo

Inox 18/10 - St. Steel

	∅ Cm	H Cm	∅ In	H In
906 05 004	25	9	9,7/8	3,1/2

**Cestino frutta tondo in filo**

Fruit basket, round, wire

Corbeille a fruits ronde en fil d'acier

Drahtobstkorb, rund

Cesta frutas redonda en hilo

Inox 18/10 - St. Steel

	∅ Cm	H Cm	∅ In	H In
906 05 003	20	8	7,7/8	3,1/8

**Cestino frutta tondo in filo**

Fruit basket, round, wire

Corbeille a fruits ronde en fil d'acier

Drahtobstkorb, rund

Cesta frutas redonda en hilo

Inox 18/10 - St. Steel

	∅ Cm	H Cm	∅ In	H In
906 05 002	18	7	7,1/8	2,3/4



Cestino in filo grissini

Bread stick basket
Corbeille à gressins
Grissini-Korb Edelstahl Draht
Cesta palillos

Inox 18/10 - St. Steel

	∅ Cm	H Cm	∅ In	H In
906 05 005	10	14	3,7/8	5,1/2

**Cestino ovale in filo**

Oval s/s basket
Corbeille ovale
Ovalkorb Edelstahl Draht
Cesta oval

Inox 18/10 - St. Steel

	Cm	H Cm	In	H In
906 05 016	28x21	9	11x8,1/4	3,1/2

**Cestino ovale in filo**

Oval s/s basket
Corbeille ovale
Ovalkorb Edelstahl Draht
Cesta oval

Inox 18/10 - St. Steel

	Cm	H Cm	In	H In
906 05 015	25x18	8	9,7/8x7	3,1/8

**Cestino ovale in filo**

Oval s/s basket
Corbeille ovale
Ovalkorb Edelstahl Draht
Cesta oval

Inox 18/10 - St. Steel

	Cm	H Cm	In	H In
906 05 014	20x15	7	7,7/8x6	2,3/4



Coppetta liscia multiuso

Small cup, plain multipurpose
 Petite coupe simple multi-usage
 Universalschale
 Copita lisa multiuso

Inox 18/10 - St. Steel

	Cm	In
V05 05 43 L13	13	5,1/8

**Cestino pane liscio Majorca**

Mallorca bread basket, plain
 Corbeille à pain Mallorca
 Brotkorb Mallorca
 Cesta pan Mallorca lisa

Inox 18/10 - St. Steel

	Cm	In
V05 05 24 L18	18,5x18,5	7,1/4 x7,1/4
V05 05 24 L23	23x23	9x9

**Cestino pane forato Majorca**

Mallorca bread basket, slotted
 Corbeille à pain Mallorca, perforée
 Lochbrotkorb Mallorca
 Cesta pan con agujeros Mallorca

Inox 18/10 - St. Steel

	Cm	In
V05 05 24 F18	18,5x18,5	7,1/4 x7,1/4
V05 05 24 F23	23x23	9x9

**Cestino pane ovale**

Bread basket, oval
 Corbeille à pain ovale
 Brotkorb, oval
 Cesta pan oval

Inox 18/10 - St. Steel

	Cm	In
V01 05 24 028	28x15	11x6



**Anello adattatore**

Adjusting ring
Bague de réglage
Einsatzring
Anillo adaptador

Inox 18/10 - St. Steel

	Cm	In
V01 05 43 540	13 Cm	5,1/8

**Coppetta interna**

Supreme inside cup
Coupe intérieure
Schale
Copita interior

Inox 18/10 - St. Steel

	Cm	In
V01 05 43 562	10,5	4,1/8

**Piattino portaburro**

Butter dish
Plat à beurre
Butterschale
Platito mantequilla

Inox 18/10 - St. Steel

	∅ Cm	∅ In
V01 05 43 648	13	5,1/8

**Griglia portaburro**

Butter grid
Grille porte-beurre
Buttergitter
Parrilla mantequilla

Inox 18/10 - St. Steel

	∅ Cm	∅ In
V01 05 43 539	13	5,1/8

**Coppa esterna base**

Supreme outside base cup
Coupe base extérieure Supreme
Schale auf Fuß
Copa exterior base Supreme

Inox 18/10 - St. Steel

	∅ Cm	∅ In
V01 05 43 130	13	5,1/8

**Coppa Supreme completa**

Supreme cup
Coupe Supreme
Hummer-/Cocktailschale
Copa Supreme, completa

Inox 18/10 - St. Steel

	∅ Cm	H Cm	∅ In	H In
V01 05 43 C13	13	8,5	5,1/8	3,3/8
3 Pezzi - 3 Pieces				

V01 05 43 C135	13	8,5 Cm	5,1/8	3,3/8
5 Pezzi - 5 Pieces				

Set breakfast

Breakfast set
 Service petit déjeuner
 Tablet mit Frühstückzubehören
 Set desayuno

Inox 18/10 - St. Steel

	Cm	In
V76 05 23 002	24	9,1/2

**Set lunch**

Lunch set
 Service lunch
 Öl und Essig set Tablett
 Set almuerzo

Inox 18/10 - St. Steel

	Cm	In
V76 05 23 003	24	9,1/2

**Set sauces appetizer**

Set sauces appetizer
 Service sauces-appetizer
 Süße und Apertiven set Soßen
 Set salsas-aperitivos

Inox 18/10 - St. Steel

	Cm	In
V76 05 23 004	24	9,1/2



Vetro salino Square c/tappo

Glass cruet salt spreader Square w/cap
 Verre pour salière Square avec couvercle
 Salzstreuer mit Schraubverschluss
 Vidrio salero Square c/tapa

Acciaio inossidabile - St. Steel

V76 05 12 001

**Ampolla olio/aceto Square c/tappo**

Glass cruet oil/vinegar set Square w/cap
 Burette huile/vinaigre Square avec bouchon
 Essig/Ölglasflasche mit Schraubverschluss
 Alcuza aceite/vinagre Square c/tapa

Acciaio inossidabile - St. Steel

V76 05 11 001

**Portatovaglioli Square**

Napkin holder
 Porte-serviettes
 Serviettenhalter
 Servilletero

Inox 18/10 - St. Steel

	Cm	H Cm	In	H In
V76 05 71 001	11x4	8	4,3/8x1,2/3	3,1/8

**Portabustine zucchero/tè**

Packed sugar/tea holder
 Conteneur sachets de sucre/té
 Zucker-Teebeutelbehälter
 Porta sobres de azúcar/té

Inox 18/10 - St. Steel

	Cm	H Cm	In	H In
V78 05 04 PBU	10x6,5	3,5	3,7/8x2,1/2	1,3/8

**Ciotola porcellana quadra**

Porcelain square bowl
 Bol carré en porcelaine
 Porzellanschale, viereckig
 Bol cuadrado de porcelana

Porcelain

	Cm	In
V86 21 42 CQ7	7x7	2,3/4x2,3/4

**Vaso Formaggiera con coperchio**

Cheese bowl
 Ravier a parmesan
 Käsedose
 Quesera

Acciaio inossidabile - St. Steel

V76 05 13 002



Coppa macedonia Imperial

Fruit salad cup
Coupe à dessert
Obstsalatschale
Copa macedonia

Inox 18/10 - St. Steel

	∅ Cm	∅ In	H Cm	H In
V01 05 43 125	12,5	5	5,5	2

**Coppa gelato**

Ice cream cup
Coupe à glace
Eisschale
Copa helado

Inox 18/10 - St. Steel

	∅ Cm	∅ In
V01 05 43 105	10,5	4,1/8

**Coppa gelato Imperial**

Imperial ice cream cup
Coupe à glace Imperial
Eisschale Imperial
Copa helado Imperial

Inox 18/10 - St. Steel

	∅ Cm	∅ In	H Cm	H In
V01 05 43 010	9,5	3,3/4	10	4

**Piattino sottocoppa**

Cup saucer
Plat sous coupe
Untersatz
Platito posacopa

Inox 18/10 - St. Steel

	∅ Cm	∅ In
V01 05 21 013	13	5,1/8

**Portafiori**

Flower vase
Vase à fleurs
Blumenvase
Florero

Inox 18/10 - St. Steel

	H Cm	H In
V01 05 19 015	16,5	6,1/2

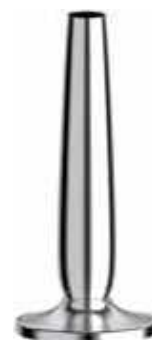

Vassoio rendiresto bordo inglese

Small change tray with English edge
 Plateau porte-monnaie avec rebord anglais
 Geldplatte mit englischem Rand
 Bandeja portamoneda con borde inglés

Inox 18/10 - St. Steel

	Cm	In
V01 05 23 R25	24x9,5	9,1/2x3,3/4

**Vassoio multiuso**

Multipurpose tray
 Plateau universelle
 Universale Platte
 Bandeja universal

Inox 18/10 - St. Steel

	Cm	In
CI 3005	24x9,5	9,1/2x3,3/4
CI 3006	29x13,5	11,1/2x5,3/8

**Salsiera con piattino**

Sauce boat with underliner
 Saucière avec soucoupe
 Soßenschüssel mit Tellerchen
 Salsera con platito

Inox 18/10 - St. Steel

	Cl	Mm
V61 05 12 030	30	0,8

**Salsiera**

Sauce boat
 Saucière
 Soßenschüssel
 Salsera

Inox 18/10 - St. Steel

	Cl	Mm
CI 25401	10	0,8
CI 25402	20	0,8
CI 25403	30	0,8

**Cloche**

Dome cover
 Cloche
 Speiseglocke
 Campana

Inox 18/10 - St. Steel

	Ø Cm	Ø In
V01 05 53 024	24	9,1/2
V01 05 53 026	26	10,1/4
V01 05 53 028	28	11
V01 05 53 030	30	11,3/4



Portatovaglioli

Napkin holder
Porte-serviette
Serviettenhalter
Servilletero

Inox 18/10 - St. Steel

	Cm	H Cm	In	H In
V01 05 71 105	10,5	9	4,1/8	3,1/2

**Portatovaglioli**

Napkin holder
Porte-serviettes
Serviettenhalter
Servilletero

Inox 18/10 - St. Steel

	Cm	H Cm	In	H In
V76 05 71 001	11x4	8	4,3/8x1,2/3	3,1/8

**Portatovaglioli quadrato**

Napkin holder, square
Porte-serviette carré
Viereckiger Serviettenhalter
Servilletero cuadrado

Inox 18/10 - St. Steel

	Cm	H Cm	In	H In
V01 05 71 190	19x19	7	7,1/2x7,1/2	2,3/4

**Portakleenex**

Kleenex holder
Porte-kleenex
Taschentücherhalter
Porta kleenex

Inox 18/10 - St. Steel

	Cm	H Cm	In	H In
V01 05 71 002	22x12	5,5	8,5/8x4,3/4	2,1/8

**Lavadita**

Finger bowl
Rince-doigts
Fingerschale
Lavadedos

Inox 18/10 - St. Steel

	∅ Cm	∅ In
V01 05 43 012	12	4,3/4



Portatovaglioli da banco verticale

Vertical napkin holder

Porte-serviettes vertical

Vertikaler Thekenserviettenhalter

Servilletero cuadrado vertical

Inox 18/10 - St. Steel

	Cm	H Cm	In	H In
906 05 008	8,5x11	16	3,3/8x4,3/8	6,1/4

**Legatovaglioli tondo**

Round napkin ring

Rond de serviette

Serviettenhalter

Servilletero redondo

Inox 18/10 - St. Steel

	∅ Cm	∅ In
V01 05 81 001	4 Cm	1,2/3

**Paletta raccoglibriciole**

Crumb sweeper

Pelle ramasse-miettes

Krümelsammler

Pala recogemigas

Inox 18/10 - St. Steel

	Cm	In
903 05 91 939	12	4,3/4

**Legatovaglioli ovale**

Oval napkin ring

Rond de serviettes ovale

Serviettenhalter, oval

Servilletero oval

Inox 18/10 - St. Steel

	Cm	In
V01 05 81 000	5x4	2x1,2/3





Segnatavolo a colonna (portanumero)

Table number stand, column-shaped

Support numéro de table à colonne

Tischnummerständer

Número sobremesa a columna

Inox 18/10 - St. Steel

	H Cm	H In
V01 05 19 019	19	7,1/2
V01 05 19 046	45	17,3/4



Cavalletto portaetichetta per buffet

Buffet easel for tags

Chevalet porte-nom pour buffet

Aufsteller Produktinfo

Soporte caballete para etiqueta para buffet

Inox 18/10 - St. Steel

	H Cm	H In
V01 05 19 001	14,5	5,3/4

Tavoletta nera per cavalletto

Black tag for easel

Plaque pour chevalet noir

Schild für Produktinfo

Etiqueta negra para soporte caballete

Plexiglass

	H Cm	H In
V01 12 19 001	10x7,5	4x3



Portatoast in filo

Toast holder, steel wire

Porte-toasts en fil

Toastständer

Portatostadas en hilo

Inox 18/10 - St. Steel

	Cm	H Cm	In	H In
V01 05 71 195	19,5	15	7,5/8	6

Formaggiara Imperial

Imperial grated-cheese holder
 Ravier à parmesan Imperial
 Käsedose Imperial
 Quesera Imperial

Inox 18/10 - St. Steel

V01 05 13 001



Oliera 4 pezzi Imperial

Imperial oil & vinegar cruet set, 4-piece
 Ménagère Imperial, 4 pièces
 Menage, 4-tlg Imperial
 Servicio de mesa Imperial, 4 piezas

Inox 18/10 - St. Steel

V01 05 11 005



Oliera 2 pezzi Imperial

Imperial oil & vinegar cruet set, 2-piece
 Ménagère Imperial, 2 pièces
 Menage, 2-tlg Imperial
 Servicio de mesa Imperial, 2 piezas

Inox 18/10 - St. Steel

V01 05 11 002



Tris sale, pepe e stecchi Imperial

Imperial salt and pepper shakers and toothpick holder
 Salière, poivrière et porte cure-dents Imperial
 Salz/Pfefferstreuer und Zahnstocherträger Imperial, 3-tlg
 Salero, pimentero y palillero Imperial

Inox 18/10 - St. Steel

V01 05 12 003



Spargi sale/pepe singolo Imperial

Imperial salt/pepper shaker
 Salière/poivrière individuelle Imperial
 Salz/Pfefferstreuer Imperial
 Salero/pimentero individual Imperial

Inox 18/10 - St. Steel

V01 05 12 001



Formaggiara 2000

2000 Cheese bowl
Fromagère 2000
Käsedose 2000
Quesera 2000

Acciaio inossidabile - St. Steel

V61 05 13 001

**Oliera 5 pezzi Menage**

Menage oil & vinegar cruet set, 5-piece
Ménagère Menage, 5 pièces
Menage, 5-tlg
Servicio de mesa Menage, 5 piezas

Acciaio inossidabile - St. Steel

V12 06 11 005

**Tris sale, pepe e stecchi Inox**

Salt and pepper shakers and toothpick holder, plain
Salière, poivrière et porte cure-dents simples
Salz/Pfefferstreuer mit Zahnstochträger, Edelstahl
Tris salero, pimentero y palillero Inox

Acciaio inossidabile - St. Steel

V12 06 12 003



Oliera 2 pezzi Victory

Victory oil & vinegar cruet set, 2-piece
 Ménagère Victory, 2 pièces
 Essig/Ölgestell 2-tlg Victory
 Servicio de mesa Victory, 2 piezas

Inox 18/10 - St. Steel

V52 05 11 002



Tris sale, pepe e stecchi Victory

Victory salt and pepper shakers and toothpick holder
 Salière, poivrière et porte cure-dents Victory
 Salz/Pfeffersteuer mit Zahnstocherträger, 3-tlg Victory
 Salero, pimentero y palillero Victory

Inox 18/10 - St. Steel

V52 05 12 003



Formaggiara Victory

Victory grated-cheese holder
 Ravier à parmesan Victory
 Käsedose Victory
 Quesera Victory

Inox 18/10 - St. Steel

V52 05 13 001



Oliera 5 pezzi Victory

Victory oil & vinegar cruet set, 5-piece
 Ménagère Victory, 5 pièces
 Essig/Ölgestell 5-tlg Victory
 Servicio de mesa Victory, 5 piezas

Inox 18/10 - St. Steel

V52 05 11 005



Sale/pepe Square

Glass cruet salt spreader Square

Verre pour salière Square

Salzstreuer mit

Vidrio salero Square

Acciaio inossidabile - St. Steel

	Cm	In	H Cm	H In
V76 05 12 002	9,5x4,5	3,3/4x1,3/4	12,5	5

**Oliera 2 pz olio/aceto Square**

Glass cruet oil/vinegar set Square

Burette huile/vinaigre Square

Essig/Ölglas flaschen mit

Alcuza aceite/vinagre Square

Acciaio inossidabile - St. Steel

	Cm	In	H Cm	H In
V76 05 11 002	12,5x5,5	5x2,1/8	20	7,7/8

**Formaggiera Square**

Cheese bowl Square

Ravier a parmesan Square

Käsedose Square

Quesera Square

Acciaio inossidabile - St. Steel

	Cm	In	H Cm	H In
V76 05 13 001	8,5x9	3,3/8x3,1/2	8,5	3,3/8





Portabottiglie olio/aceto con spargisale/pepe

Oil and vinegar bottle rack with salt and pepper shakers
 Porte bouteilles huile-vinaigre, salière, poivrière
 Essig/Ölflaschenträger, Salz/Pfeffersteuer
 Portabotellas aceite y vinagre, salero, pimentero

Acciaio inossidabile - St. Steel

	Cl	Oz	Cm
AVARI 060 A	25	9	12x5,5x25
AVARI 061 A	50	17,5	14x7x81



Portabottiglie olio/aceto

Oil and vinegar bottle rack
 Porte bouteilles huile-vinaigre
 Essig/Ölflaschenträger
 Portabotellas aceite y vinagre

Acciaio inossidabile - St. Steel

	Cl	Oz	Cm
AVARI 060	25	9	12x6,5x25
AVARI 061	50	17,5	14,5x7,5x32

Oliera Pasha

Pasha oil & vinegar cruet set
Ménagère Pasha
Menage Pasha
Servicio de mesa Pasha

- V02 12 11 004 07
- V02 12 11 004 12
- V02 12 11 004 13
- V02 12 11 004 34
- V02 12 11 004 47

**Oliera Jolly**

Jolly oil & vinegar cruet set
Ménagère Jolly
Menage Jolly
Servicio de mesa Jolly

- V10 12 11 004 41
- V10 12 11 004 34
- V10 12 11 004 43
- V10 12 11 004 38
- V10 12 11 004 40
- V10 12 11 004 47

**Formaggiera Pasha con vaso vetro**

Pasha grated-cheese holder
Ravier à parmesan Pasha
Käsedose Pasha
Quesera Pasha

PP+PS

- V02 12 13 001 07
- V02 12 13 001 12
- V02 12 13 001 13
- V02 12 13 001 34
- V02 12 13 001 47

**Formaggiera Jolly**

Jolly grated-cheese holder
Ravier à parmesan Jolly
Käsedose Jolly
Quesera Jolly

PP+PS

- V10 12 13 001 41
- V10 12 13 001 34
- V10 12 13 001 43
- V10 12 13 001 38
- V10 12 13 001 40
- V10 12 13 001 47



Ricambi Imperial/Victory

Imperial/Victory spare parts
Pièces de rechange Imperial/Victory
Imperial/Victory Ersatzteilen
Repuestos Imperial/Victory

AR33 TAPPO OLIERA CON SALVAGOCCIA / DROP STOP CAP OIL CRUETS

AR31 CAPSULA SALINO / CAP SALT SHAKER

AR32 CAPSULA STECCHI / CAP TOOTHPICK HOLDERS



AR31

AR32

Ricambi Cronos

Cronos spare parts
Pièces de rechange Cronos
Cronos Ersatzteilen
Repuestos Cronos

AR8 TAPPO OLIERA CON SALVAGOCCIA / DROP STOP CAP OIL CRUETS

AR12 CAPSULA SALE E PEPE / CAP FOR SALT AND PEPPER

AR25 CAPSULA STECCHI / CAP FOR TOOTHPICK



AR8

AR12



AR25

Ampolla vetro oliera Cronos/Imperial/Victory

Glass cruet for Cronos/Imperial/Victory cruet sets
Bouchon anti-goutte pour huilier Imperial/Victory
Glas Ersatzteil für Öl-und Essigset
Tapón antigoteo para aceitera Imperial/Victory

	∅ Cm	H Cm	∅ In	H In
AR3	5	13,5	2	5,3/8



Vetro formaggiiera Cronos/Imperial/Pasha/Jolly

Glass bowl for Cronos/Imperial/Pasha/Jolly
Bol en verre pour ravier à parmesan Cronos/Imperial/Pasha/Jolly
Glas Ersatzteil für Käsedose Cronos/Imperial/Pasha/Jolly
Bol de vidrio para Cronos/Imperial/Pasha/Jolly

	∅ Cm	H Cm	∅ In	H In
AR14	9	4,9	3,1/2	2



Vetro salino Mondial/Cronos/Imperial/Pasha/Jolly/Menage/Dribbly

Glass bowl for Mondial/Cronos/Imperial/Pasha/Jolly/Menage/Dribbly salt/pepper shakers
Bouteille verre pour salière Mondial/Cronos/Imperial/Pasha/Jolly/Menage/Dribbly
Glas Ersatzteil für Salz und Pfefferstreuer
Botellita de vidrio para salino Mondial/Cronos/Imperial/Pasha/Jolly/Menage/Dribbly shakers

	∅ Cm	H Cm	∅ In	H In
AR4	3-5	8	1,3/8	3,1/8



Vassoio tondo bar

Round bar tray
Plateau rond bar
Austellplatte, rund
Bandeja redonda bar

Inox 18/10 - St. Steel

	∅ Cm	∅ In
V01 05 23 T32	32	12,5/8
V01 05 23 T38	38	15
V01 05 23 T46	46	18,1/8
V01 05 23 T54	54	21,1/4

**Vassoio tondo bar con maniglie**

Round bar tray with handles
Plateau rond bar avec poignées
Austellplatte mit Griffen, rund
Bandeja redonda bar con asas

Inox 18/10 - St. Steel

	∅ Cm	∅ In
V01 05 23 T32M	32	12,5/8
V01 05 23 T38M	38	15
V01 05 23 T46M	46	18,1/8
V01 05 23 T54M	54	21,1/4

**Vassoio tondo con bordo Basic**

Round tray Basic
Plateau rond Basic
Austellplatte, rund Basic
Bandeja redonda Basic

Inox 18/10 - St. Steel

	∅ Cm est.	∅ Cm Int.	∅ In ext.	∅ In Int.
V01 05 23 TB31	31	27	12,1/4	10,5/8
V01 05 23 TB36	36	30	14,1/8	11,3/4
V01 05 23 TB41	41	35	16,1/8	13,3/4

**Vassoio birra**

Beer tray
Plateau à bière
Bierplatte
Bandeja para cerveza

Inox 18/10 - St. Steel

	∅ Cm	∅ In
CI 5411	30	11,3/4
CI 5412	40	15,3/4



Vassoio rettangolare gastronorm

Gastronorm tray, rectangular
 Plateau rectangulaire Gastronorm
 Austellplatte, rechteckig, Gastronorm
 Bandeja rectangular Gastronorm

Inox 18/10 - St. Steel

	Cm	In
V01 05 23 G12	26,5x32,5	10,3/8x12,3/4
V01 05 23 G11	53x32,5	20,7/8x12,3/4
V01 05 23 G21	65x53	25,5/8x20,7/8

**Vassoio rettangolare gastronorm con maniglie**

Gastronorm tray with handles, rectangular
 Plateau rectangulaire Gastronorm avec poignées
 Austellplatte mit Griffen, rechteckig, Gastronorm
 Bandeja rectangular Gastronorm con asas

Inox 18/10 - St. Steel

	Cm	In
V01 05 23 G12M	32,5x26,5	12,3/4x10,3/8
V01 05 23 G11M	53x32,5	20,7/8x12,3/4
V01 05 23 G21M	65x53	25,5/8x20,7/8

**Vassoio rettangolare Basic**

Gastronorm tray, rectangular
 Plateau rectangulaire Gastronorm
 Austellplatte, rechteckig, Gastronorm
 Bandeja rectangular Gastronorm

Inox 18/10 - St. Steel

	Cm	In
V01 05 23 GB12	26,5x32,5	10,3/8x12,3/4
V01 05 23 GB11	53x32,5	20,7/8x12,3/4
V01 05 23 GB21	65x53	25,5/8x20,7/8

**Vassoio gratin ovale**

Gratin tray
 Plat gratin ovale
 Ovale Gratinplatte
 Plato gratin oval

Inox 18/10 - St. Steel

	Cm	In
CI 24501	28x17	11x6,3/4



Vassoio rettangolare bar con bordo

Bar tray with edge, rectangular
 Plateau rectangulaire bar avec rebord
 Austellplatte, rechteckig
 Bandeja rectangular bar con borde

Inox 18/10 - St. Steel

	Cm	In	Sp. mm
V01 05 23 R30	30x24	11,3/4x9,1/2	0,8
V01 05 23 R35	35x29	13,3/4x11,1/2	0,8
V01 05 23 R40	40x31	15,3/4x12,1/4	1,0
V01 05 23 R45	45x34	17,3/4x13,3/8	1,0
V01 05 23 R52	52x40	20,1/2x15,3/4	1,0
V01 05 23 R62	62x48	24,3/8x19	1,0

**Vassoio rettangolare bar senza bordo**

Bar tray without edge, rectangular
 Plateau rectangulaire bar sans rebord
 Austellplatte rechteckig
 Bandeja rectangular bar sin borde

Inox 18/10 - St. Steel

	Cm	In	Sp. mm
V03 05 23 R27	27x21	10,5/8x8,1/4	0,8
V03 05 23 R30	30x24	11,3/4x9,1/2	0,8
V03 05 23 R35	35x28	13,3/4x11	0,8
V03 05 23 R40	40x32	15,3/4x12,5/8	1,0
V03 05 23 R45	45x35	17,3/4x13,3/4	1,0
V03 05 23 R50	50x38	19,3/4x15	1,0

**Vassoio rettangolare bar Easy con bordo**

Easy bar tray with edge, rectangular
 Plateau rectangulaire bar Easy avec rebord
 Rechteckig Ausstellplatte "Easy" mit Rand
 Bandeja rectangular bar Easy con borde

Inox 18/CR - St. Steel

	Cm	In	Sp. mm
V65 05 23 R32	32x26	12,5/8x10,1/4	0,6
V65 05 23 R36	36x29	14,1/8x11,1/2	0,6
V65 05 23 R40	40x33	15,3/4x13	0,6
V65 05 23 R45	45x34	17,3/4x13,3/8	0,6

**Vassoio rettangolare bar senza bordo**

Bar tray without edge, rectangular
 Plateau rectangulaire bar sans rebord
 Austellplatte rechteckig
 Bandeja rectangular bar sin borde

Inox 18/CR - St. Steel

	Cm	In	Sp. mm
V03 06 23 R27	27x21	10,5/8x8,1/4	0,8
V03 06 23 R31	30x24	11,3/4x9,1/2	0,8
V03 06 23 R36	35x28	13,3/4x11	0,8
V03 06 23 R40	40x32	15,3/4x12,5/8	1,0
V03 06 23 R45	45x35	17,3/4x13,3/4	1,0
V03 06 23 R50	50x38	19,3/4x15	1,0



Piatto portata ovale con bordo Easy

Easy plate with edge, oval
Assiette ovale Easy avec rebord
Oval Tablett "Easy" mit Rand
Fuente oval Easy con borde

Inox 18/CR - St. Steel

	Cm	In
V65 05 23 020	20X11	7,7/8x4,3/8
V65 05 23 025	25x17	9,7/8x6,3/4
V65 05 23 030	30x21	11,3/4x8,1/4
V65 05 23 035	35x24	13,3/4x9,1/2
V65 05 23 040	40x27	15,3/4x10,5/8
V65 05 23 045	45x30	17,3/4x11,3/4
V65 05 23 050	50x33	19,3/4x13
V65 05 23 059	59X40	23,1/4x15,3/4

**Piatto ovale senza bordo**

Plate without edge, oval
Assiette ovale sans rebord
Bratenplatte, oval
Fuente oval sin borde

Inox 18/10 - St. Steel

	Cm	In
V03 05 22 025	25x17	9,7/8x6,3/4
V03 05 22 030	30x21	11,3/4x8,1/4
V03 05 22 035	35x24	13,3/4x9,1/2
V03 05 22 040	40x27	15,3/4x10,5/8
V03 05 22 045	45x31	17,3/4x12,1/4
V03 05 22 050	50x35	19,3/4x13,3/4

**Piatto portata tondo con bordo**

Plate with edge, round
Assiette ronde avec rebord
Bratenplatte, rund mit Rand
Fuente redonda con borde

Inox 18/10 - St. Steel

	∅ Cm est.	∅ Cm Int.	∅ In ext.	∅ In Int.
V01 05 22 T29	29	20	11,1/2	7,7/8
V01 05 22 T34	34	24	13,3/8	9,1/2
V01 05 22 T38	38	26	15	10,1/4

**Piatto portata pesce**

Fish plate
Assiette à poisson
Fischplatte
Fuente para pescado

Inox 18/CR - St. Steel

	Cm	In
V01 05 22 P60	60x24,5	23,5/8x9,5/8
V01 05 22 P70	70x28,5	27,1/2x11,1/4



Vassoio sovrapponibile gastronomo rettangolare

Stackable gastronorm rectangular tray

Plateau empilable gastronorme rectangulaire avec poignées

Gastronorm Tablett - rund und stapelbar

Bandeja rectangular gastronorm apilable

Inox 18/10 - St. Steel

	Cm	In
V01 05 23 G11S	53x32,5	20,7/8x12,3/4
V01 05 23 G21S	65x53	25,5/8x20,7/8

**Vassoio sovrapponibile gastronomo tondo**

Stackable gastronorm round tray

Plateau empilable rond avec poignées

Tablett-rund und stapelbar

Bandeja redonda gastronorm apilable

Inox 18/10 - St. Steel

	∅ Cm	∅ In
V01 05 23 T46S	46	18,1/8
V01 05 23 T54S	54	21,1/4



Coperchio legumiera/zuppiera

Cover for vegetable dish/soup tureen

Couvercle pour soupière/légumier

Deckel für Suppen-Gemüseschüssel

Tapa legumbrera/sopera

Inox 18/10 - St. Steel

	ø Cm	ø In
V01 05 15 C14	14	5,1/2
V01 05 15 C18	18	7,1/8
V01 05 15 C22	22	8,5/8
V01 05 15 C24	24	9,1/2
V01 05 15 C26	26	10,1/4
V01 05 15 C28	28	11
V01 05 15 C30	30	11,3/4

**Zuppiera**

Soup tureen

Soupière

Suppenschüssel

Sopera

Inox 18/10 - St. Steel

	ø Cm	ø In	Lt	Oz
V01 05 15 Z14	14	5,1/2	0,75	25
V01 05 15 Z18	18	7,1/8	1,5	50
V01 05 15 Z22	22	8,5/8	2,5	85
V01 05 15 Z24	24	9,1/2	3,5	118
V01 05 15 Z26	26	10,1/4	4,25	144
V01 05 15 Z28	28	11	5,25	178
V01 05 15 Z30	30	11,3/4	6,5	220

**Legumiera**

Vegetable dish

Légumier

Gemüseschüssel

Legumbrera

Inox 18/10 - St. Steel

	ø Cm	ø In	Lt	Oz
V01 05 15 L14	14	5,1/2	0,8	27
V01 05 15 L18	18	7,1/8	1,4	47
V01 05 15 L22	22	8,5/8	1,9	64
V01 05 15 L24	24	9,1/2	2,8	94,6
V01 05 15 L26	26	10,1/4	3,8	128,5
V01 05 15 L28	28	11	4,8	162





Celsius è il nuovo piatto che mantiene costante la temperatura delle pietanze senza continuare il processo di cottura, per conservare al meglio il gusto di ogni ricetta.

Design moderno ed essenziale, che si abbina a ogni mise en place e innovativa funzionalità grazie alla presa ergonomica della base in legno, che protegge dalle scottature.

La piastra in alluminio viene **riscaldata in forno**, regolando temperatura e tempo a seconda della pietanza, per poi essere posizionata sotto il piatto in acciaio che, a contatto con gli alimenti, **mantiene costante la temperatura** del cibo durante il pasto.

Celsius è un prodotto **igienico e di facile pulizia**: il piatto in acciaio (unica componente a contatto con gli alimenti) è comodamente lavabile in lavastoviglie, a differenza delle pietre ollari che assorbono i grassi, non sono lavabili e alterano lo stato di cottura delle pietanze.

Celsius è disponibile in quattro versioni per rispondere a ogni esigenza, dal singolo posto tavola ai momenti di convivialità, e in due forme adatte a diverse tipologie di pietanze come ad esempio le carni e la pizza.

Celsius. Per non servire più cibi freddi!

Celsius is the new plate that keeps food temperature constant without continuing the cooking process, to best preserve the taste of every recipe.

Modern and essential design, matching with every place setting, and innovative functionality, thanks to the ergonomic grip, and the wood base, that protects from burning.

The aluminum plate is **warmed into the oven**, adjusting temperature and time based on the food; then it is placed under the steel plate that, in contact with food, **keeps its temperature constant** during the meal.

Celsius is a healthy product and **easy to clean**: the steel plate (the only component in contact with food) is dishwasher safe while, for instance, soapstone, that absorbs fat, is not washable and alters food cooking.

Celsius comes in four versions to meet every need, from the individual place setting to the large gatherings, and in two different shapes, suitable for different foods, like meat and pizza.

Celsius. You will not serve cold food anymore!



Celsius

IDEALE PER SERVIRE
PERFECT TO SERVE



CARNE
MEAT



PESCE
FISH



VERDURE
VEGETABLES



PIZZA E NON SOLO
PIZZA & MORE

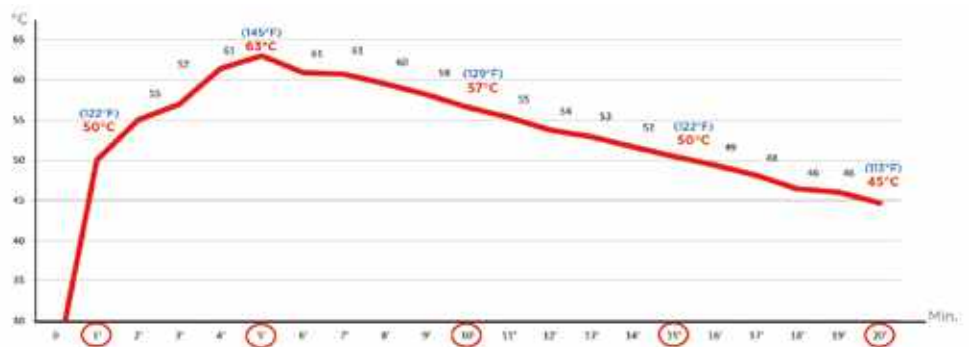

Vassoio grill rettangolare

Rectangular grill tray
 Plateau grill rectangulaire
 Grilltablett rechteckig
 Bandeja grill rectangular

	Cm	In
V89 05 22 R01	29x20	11,1/2x7,7/8
V89 05 22 R02	34x24	13,3/8x9,1/2

**Piatto**

Plate
 Plat
 Edelstahl Tablett rechteckig
 Plato

Acciaio Inox 18/10 - Stainless Steel 18/10

	Cm	In
Z89 14 22 R01	29x20	9,7/8x7,1/4
Z89 14 22 R02	34x24	11,5/8x8,1/2

**Piastra alluminio**

Aluminum plate
 Plaque aluminium
 Aluminiumplatte
 Placa aluminium

Alluminio - Aluminum

	Cm	In
Z89 15 22 R01	19x12	7,1/2x4,3/4
Z89 15 22 R02	24x15,5	9,1/2x6,1/8

**Base rettangolare**

Rectangular base
 Base rectangulaire
 Holzgestell rechteckig
 Base rectangular

Legno di betulla - Birch wood

	Cm	In
Z89 19 22 R01	29x20	11,1/2x7,7/8
Z89 19 22 R02	34x24	13,3/8x9,1/2

Vassoio grill ovale

Oval grill tray
Plateau grill oval
Grilltablett oval
Bandeja grill oval

	Cm	In
V89 05 22 T01	28x32	1x12,5/8
V89 05 22 T02	38x34	15x13,3/8



Piatto

Plate
Plat
Edelstahl Tablett oval
Plato

Acciaio Inox 18/10 - Stainless Steel 18/10

	ø Cm	ø In
Z89 14 22 T01	25,5	10
Z89 14 22 T02	31,5	12,3/8



Piastra alluminio

Aluminum plate
Plaque aluminium
Aluminiumplatte
Placa aluminium

Alluminio - Aluminum

	ø Cm	ø In
Z89 15 22 T01	20	7,7/8
Z89 15 22 T02	24	9,1/2



Base ovale

Oval base
Base ovale
Holzgestell oval
Base oval

Legno di betulla - Birch wood

	Cm	In
Z89 19 22 T01	28x32	1x12,5/8
Z89 19 22 T02	38x34	15x13,3/8





WINE ● BAR

Glacette doppio corpo

Double wall bottle cooler
 Rafrâchisseur à bouteille/vin double paroi
 Weinkühler, doppelwandig
 Enfriador de botella doble pared

Inox 18/10 - St. Steel

	∅ Cm	∅ In	H Cm	H In
V78 05 24 014	13	5,1/8	21	8,1/4

**Secchio champagne per 2/3 bottiglie**

Champagne cooler for 2/3 bottles
 Seau à champagne pour 2/3 bouteilles
 2/3 Flaschen Champagnekühler
 Cubo champán para 2/3 botellas

Inox 18/10 - St. Steel

	∅ Cm	∅ In	H Cm	H In
V78 05 20 022	22	8,5/8	21	8,1/4

**Supporto secchio spumante linea Wine&Bar**

Wine&Bar champagne cooler stand
 Support pour seau à champagne Wine&Bar
 Wine&Bar Champagnekühler Ständer
 Soporte para cubo champán Wine&Bar

Inox 18/10 - St. Steel

	∅ Cm	∅ In	H Cm	H In
V78 05 20 675	23	9	58	22,7/8

Shaker

Cocktail shaker
Shaker
Cocktail Shaker
Coctelera

Inox 18/10 - St. Steel

	Lt	Oz
V78 05 81 SHA	0,7	17

**Bicchieri Boston**

Boston mixing container
Verre en métal pour Boston
Boston Metallbecher
Vaso en metal para Boston

Inox 18/10 | vetro - St. Steel | glass

	Lt	ø Cm	H Cm	
V78 05 81 SHA 2B 0,7	9	17	6,3/4	acciaio
V78 08 81 SHA 2B 0,7	9	17	6,3/4	vetro

**Secchiello ghiaccio doppio corpo**

Double wall ice bucket
Seau à glace double paroi
Eiswürfelbehälter, doppelwandig
Cubo hielo doble pared

Inox 18/10 - St. Steel

	ø Cm	ø In	H Cm	H In
V78 05 20 014	13	5,1/8	18	7,1/8

**Scoladecanter**

Decanter wine stand
Egouttoir de carafe
Karaffentrockner
Soporte para decantador

Acciaio inossidabile - St. Steel

	H Cm	H In
V01 05 24 020	30	11,3/4

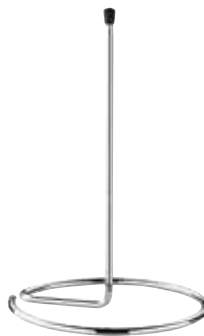
**Versavino**

Red wine holder
Porte-bouteille
Portabotella
Rotweinwiege

Inox 18/10 - St. Steel

	Cm	In
V01 05 24 002	30	11,3/4



Secchio ghiaccio Modern

Modern ice bucket
 Seau à glace Modern
 Eiswürfelbehälter Modern
 Cubo hielo Modern

Inox 18/10 - St. Steel

		∅ Cm	∅ In	H Cm	H In
V78 05 20 00 11 401	est	15	6	17	6,3/4
	int	13	5,1/8		

**Secchio champagne Modern**

Modern Champagne cooler
 Seau à champagne Modern
 Modern Champagnekühler
 Cubo champán Modern

Acciaio Inossidabile - St. Steel

		∅ Cm	∅ In	H Cm	H In
V78 05 20 002		24	9,1/2	22,5	8,7/8

**Glacette**

Modern glacette
 Glacette Modern
 Weinkühler Modern
 Enfriador de botella

Acciaio Inossidabile - St. Steel

		∅ Cm	∅ In	H Cm	H In
V78 05 24 01 01 401	est	12	4.3/4	19,5	7,5/8
	int	10	4		

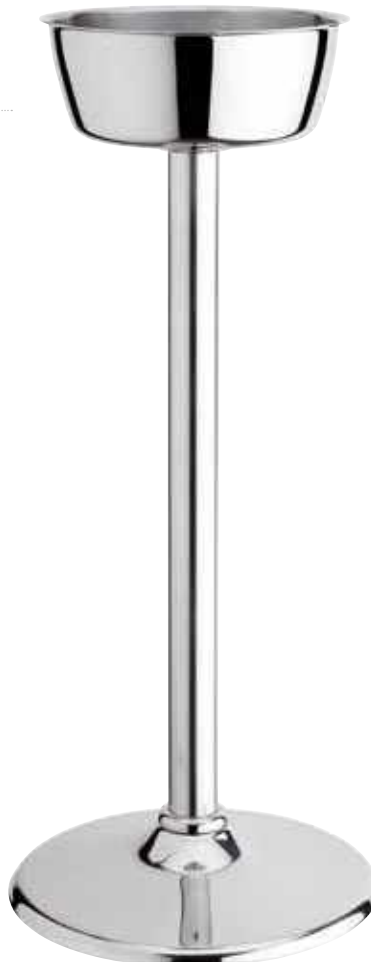
**Supporto secchio Basic**

Basic champagne cooler stand
 Support pour seau à champagne Basic
 Basic Champagnekühler Ständer
 Soporte para cubo champán Basic

Inox 18/10 - St. Steel

	H Cm	∅ Cm	H In	∅ In
V01 05 20 674	61	21	24	8,1/4

Secchio ghiaccio Imperial

Imperial ice bucket
 Seau à glace Imperial
 Imperial Eiswürfelbehälter
 Cubo hielo Imperial

Acciaio inossidabile - St. Steel

	ø Cm	ø In	H Cm	H In
V01 05 20 013	13,5	5,3/8	13	5,1/8

**Secchio champagne Imperial**

Imperial champagne cooler
 Seau à champagne Imperial
 Imperial Champagnekühler
 Cubo champán Imperial

Acciaio inossidabile - St. Steel

	ø Cm	ø In	H Cm	H In
V01 05 20 020	21	8,1/4	20	7,7/8

**Supporto secchio Imperial**

Imperial champagne cooler stand
 Support pour seau à champagne Imperial
 Imperial Champagnekühler Ständer
 Soporte para cubo champán Imperial

Inox 18/10 - St. Steel

	ø Cm	ø In	H Cm	H In
V01 05 20 675	21	8,1/4	61	24

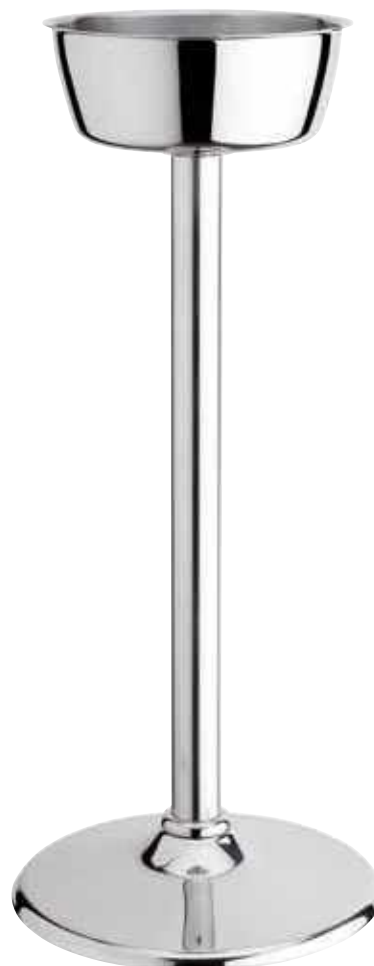

Secchio champagne Basic

Basic champagne bucket

Seau à champagne Basic

Sektkübler Basic

Cubo champán Basic

Acciaio inossidabile - St. Steel

	ø Cm	ø In	H Cm	H In
906 05 013	21,5	8,1/2	21	8,1/4

**Secchio ghiaccio Basic**

Basic ice bucket

Seau à glace Basic

Eiskühler Basic

Cubo hielo Basic

Acciaio inossidabile - St. Steel

	ø Cm	ø In	H Cm	H In
906 05 012	13	5,1/8	13	5,1/8

**Cocktail shaker Basic**

Basic cocktail shaker

Cocktail shaker Basic

Cocktail Shaker Basic

Coctelera Basic

Acciaio inossidabile - St. Steel

	Lt	Oz
V78 05 81 SHA11 401	0,5	17

**Misurino Basic**

Basic jigger

Mésure Basic

Meßbecher Basic

Medida bar Basic

Acciaio inossidabile - St. Steel

	Ml	Oz
V78 05 81 DOS1	15-30	1/2-1

**Filtro cocktail Basic**

Basic cocktail strainer

Passoire à cocktail Basic

Barsieb Basic

Colador de cóctel Basic

Acciaio inossidabile - St. Steel

	Cm	In
V78 05 81 FCO1	14	5,1/2

**Denocciatore**

Olive and cherry pitter

Dénoyateur à olives Entkerner

Entkerner

Deshuesador aceitunas

Inox 18/10 - St. Steel

	Cm	In
V78 05 81 DEN	16,2	6,3/8



Coppa punch

Punch bowl
Bol à punch
Punchschale
Champañera

Inox 18/10 - St. Steel

	ø Cm	ø In	Lt	Oz
V77 05 52 PUN	40	15,3/4	13	439,5

**Coppa champagne con base**

Champagne-bottle holder with base
Coupe à champagne avec base
Champagnerschale mit Basis
Champañera con base

Inox 18/10 - St. Steel

	ø Cm	ø In	Lt	Oz
V77 05 52 PUN3	53	20,7/8	25	845

**Coppa punch doppio corpo**

Punch bowl double-wall
Bol à punch double paroi
Doppelwandiger Punchschale
Champañera doble pared

Inox 18/10 - St. Steel

	ø Cm	ø In	Lt	Oz
V77 05 52 PUN2	39	15,3/8	10	338

**Coppa champagne**

Champagne bottle holder
Coupe à champagne
Champagnerschale
Champañera

Inox 18/10 - St. Steel

	ø Cm	ø In	Lt	Oz
V77 05 52 PUN1	53	20,7/8	25	845



Cremiera Imperial

Imperial creampot
Crémier Imperial
Imperial Sahnekännchen
Jarrita de leche Imperial

Inox 18/10 - St. Steel

	Cl	Oz
V01 05 03 015	15	5

**Lattiera Imperial**

Imperial milkpot
Pot à lait Imperial
Imperial Milchkanne
Lechera Imperial

Inox 18/10 - St. Steel

	Cl	Oz
V01 05 03 035	35	12
V01 05 03 060	60	20
V01 05 03 100	100	35

**Porta cucchiaini**

Spoon holder
Porte-cuillères
Löffelbehälter
Portacucharillas

Inox 18/10 - St. Steel

	ø Cm	ø In	H Cm	H In
V01 05 71 008	9	3,1/2	8	3,1/8

**Portacannucce**

Straw holder
Porte-pailles
Trinkhalmbehälter
Porta pajitas

Inox 18/10 - St. Steel

	ø Cm	ø In	H Cm	H In
V01 05 71 011	9	3,1/2	11	4,3/8



Portacucchiaini a 3 posti Europa

Europa spoon holder, 3-sector
 Porte cuillères 3 secteurs Europa
 Kaffeelöffelständer 3 Sektoren Europa
 Porta cucharitas 3 sectores Europa

Inox 18/10 - St. Steel

	Cm	In	H Cm	H In
CI 22202	27x8	10,5/8x3,1/8	8,5-10-12	3,3/8 - 4 - 4,3/4



Portacucchiaini a 2 posti Europa

Europa spoon holder, 2-sector
 Porte cuillères 2 secteurs Europa
 Kaffeelöffelständer 2 Sektoren Europa
 Porta cucharitas 2 sectores Europa

Inox 18/10 - St. Steel

	Cm	In	H Cm	H In
CI 22201	17x8	6,3/4x3,1/8	8,5 - 10	3,3/8 - 4



Spargicacao con coperchio in plastica

Cocoa shaker with plastic cover
 Saupoudreuse de cacao à couvercle en plastique
 Kakaostreuer mit Plastikdeckel
 Espolvoreador con tapa en plástico

Inox 18/10 - St. Steel

	Ø Cm	Ø In
909 05 XX 028	5,3	2,1/8



Portabustine zucchero/tè

Packed sugar/tea holder
 Conteneur sachets de sucre/té
 Zucker und-Teebeutel Behälter
 Portasobres de azúcar/té

Inox 18/10 - St. Steel

	Cm	In	H Cm	H In
V78 05 04 PBU	10x6,5	3,7/8x2,1/2	3,5	1,3/8



Portatovaglioli Square

Napkin holder
 Porte-serviettes
 Serviettenhalter
 Servilletero

Inox 18/10 - St. Steel

	Cm	In	H Cm	H In
V76 05 71 001	11x4	4,3/8x1,2/3	2	3,1/8



Portatovaglioli da banco verticale

Vertical napkin holder
 Porte-serviettes vertical
 Vertikaler Thekenserviettenhalter
 Servilletero cuadrado vertical

Inox 18/10 - St. Steel

	Cm	In	H Cm	H In
906 05 008	8,5x11	3,3/8x4,3/8	16	6,1/4



Portabrioche singolo

Croissant tray

Plateau porte-croissants

Brot Büfettkorb

Bandeja de buffet

PP e SAN

	Cm	In	H Cm	H In
V77 12 52 01P	50x30,5	19,5/8x12,1/8	18,5	7,1/4
V77 12 52 03P	40x24,5	15,3x9,5/8	15,5	6,1/8

**Portabrioche doppio**

Double-deck croissant tray

Porte-croissants deux étages

Doppelsplatte Brot Büfettkorb

Bandeja de buffet con dos pisos

PP e SAN

	Cm	In	H Cm	H In
V77 12 52 02P	50x30,5	19,5/8x12,1/8	39	15,3/8

**Portabrioche tondo**

Round croissant tray

Porte-croissants rond

Brot Büfettkorb rund

Bandeja de buffet redonda

PP e SAN

	ø Cm	ø In
V77 12 52 0TP	46	18,1/8
V77 12 52 0TP1	38	15



Portaformaggi/affettati refrigerato singolo

Thermal food tray rectangular
 Porte-dîner rectangulaire réfrigérant individuel
 Wurstwarenplatte, rechteckig
 Bandeja portaquesos/embutidos rectangular refrigerante individual

PP e SAN

	Cm	In	H Cm	H In
V77 12 54 01P	50x30,5	19,5/8x12,1/8	18,5	7,1/4

**Portaformaggi/affettati refrigerato doppio**

Thermal food tray rectangular, double
 Porte-dîner rectangulaire réfrigérant double
 Doppelwurstwarenplatte, rechteckig
 Bandeja portaquesos rectangular refrigerante doble

PP e SAN

	Cm	In	H Cm	H In
V77 12 54 02P	50x30,5	19,5/8x12,1/8	39	15,3/8

**Eutettici rettangolari**

Ice packs
 Blocs réfrigérants
 Kühlakkus
 Acumuladores de frío rectangulares

V77 12 95 G00

**Base coprieutettici per portaformaggi refrigerato**

Ice pack cover for termale rectangular cheese dish
 Base couvre blocs réfrigérants pour porte-dimer réfrigérant
 Kühlakkus scheinbe für Wurstwaremplate, rechteckig
 Base para acumuladores de frío para bandeja portaquesos refrigerante

Inox 18/10 - St. Steel

	Cm	In
Z77 19 54 01P	43,5x24	17,1/8x9,1/2





CUCINA • KITCHEN

I contenitori Gastronorm sono studiati e realizzati in conformità alla normativa UNI EN 631-1. Realizzati in AISI 304 (1.4301) per garantire un'ottima resistenza alla corrosione; l'AISI 304 è un acciaio austenitico che può essere utilizzato a contatto con gli alimenti secondo il decreto 11 Novembre 2013 Nr. 140.

Gastronorm containers are designed and manufactured in compliance with UNI EN 631-1 regulation. Made of AISI 304 (1.4301) to ensure an excellent corrosion resistance; AISI 304 is an austenitic steel that can be used in contact with food according to the Decree of 11 November 2013 No. 140.

Contentitore GN 2/1

GN 2/1 container

Conteneur GN 2/1

GN Behälter Edelstahl Gn 2/1

Contenedor GN 2/1

Inox 18/10 - St. Steel

	Cm	H Cm	Sp. Mm
V01 05 72 G21	65x53	2	0,7
V01 05 72 G21A	65x53	4	0,7
V01 05 72 G21B	65x53	6,5	0,7
V01 05 72 G21C	65x53	10	0,7
V01 05 72 G21D	65x53	15	0,7
V01 05 72 G21E	65x53	20	0,7

**Contentitore GN 1/1**

GN 1/1 container

Conteneur GN 1/1

GN Behälter Edelstahl Gn 1/1

Contenedor GN 1/1

Inox 18/10 - St. Steel

	Cm	H Cm	Sp. Mm
V01 05 72 G11	53x32,5	2	0,7
V01 05 72 G11A	53x32,5	4	0,7
V01 05 72 G11B	53x32,5	6,5	0,7
V01 05 72 G11C	53x32,5	10	0,7
V01 05 72 G11D	53x32,5	15	0,7
V01 05 72 G11E	53x32,5	20	0,7

**Contentitore GN 2/3**

GN 2/3 container

Conteneur GN 2/3

GN Behälter Edelstahl Gn 2/3

Contenedor GN 2/3

Inox 18/10 - St. Steel

	Cm	H Cm	Sp. Mm
V01 05 72 G23	35,4x32,5	2	0,7
V01 05 72 G23A	35,4x32,5	4	0,7
V01 05 72 G23B	35,4x32,5	6,5	0,7
V01 05 72 G23C	35,4x32,5	10	0,7
V01 05 72 G23D	35,4x32,5	15	0,7
V01 05 72 G23E	35,4x32,5	20	0,7



Contentore GN 1/2

GN 1/2 container
 Conteneur GN 1/2
 GN Behälter Edelstahl Gn 1/2
 Contenedor GN 1/2

Inox 18/10 - St. Steel

	Cm	H Cm	Sp. Mm
V01 05 72 G12	32,5x26,5	2	0,7
V01 05 72 G12A	32,5x26,5	4	0,7
V01 05 72 G12B	32,5x26,5	6,5	0,7
V01 05 72 G12C	32,5x26,5	10	0,7
V01 05 72 G12D	32,5x26,5	15	0,7
V01 05 72 G12E	32,5x26,5	20	0,7



Contentore GN 2/4

GN 2/4 container
 Conteneur GN2/4
 GN Behälter Edelstahl Gn 2/4
 Contenedor GN 2/4

Inox 18/10 - St. Steel

	Cm	H Cm	Sp. Mm
V01 05 72 G24	16,2x53	2	0,7
V01 05 72 G24A	16,2x53	4	0,7
V01 05 72 G24B	16,2x53	6,5	0,7
V01 05 72 G24C	16,2x53	10	0,7
V01 05 72 G24D	16,2x53	15	0,7



Contentore GN 1/3

GN 1/3 container
 Conteneur GN 1/3
 GN Behälter Edelstahl Gn 1/3
 Contenedor GN 1/3

Inox 18/10 - St. Steel

	Cm	H Cm	Sp. Mm
V01 05 72 G13	32,5x17,6	2	0,7
V01 05 72 G13A	32,5x17,6	4	0,7
V01 05 72 G13B	32,5x17,6	6,5	0,7
V01 05 72 G13C	32,5x17,6	10	0,7
V01 05 72 G13D	32,5x17,6	15	0,7
V01 05 72 G13E	32,5x17,6	20	0,7



Contentore GN 1/4

GN 1/4 container

Conteneur GN 1/4

GN Behälter Edelstahl Gn 1/4

Contenedor GN 1/4

Inox 18/10 - St. Steel

	Cm	H Cm	Sp. Mm
V01 05 72 G14	26,5x16,2	2	0,7
V01 05 72 G14A	26,5x16,2	4	0,7
V01 05 72 G14B	26,5x16,2	6,5	0,7
V01 05 72 G14C	26,5x16,2	10	0,7
V01 05 72 G14D	26,5x16,2	15	0,7
V01 05 72 G14E	26,5x16,2	20	0,7

**Contentore GN 1/6**

GN 1/6 container

Conteneur GN 1/6

GN Behälter Edelstahl Gn 1/6

Contenedor GN 1/6

Inox 18/10 - St. Steel

	Cm	H Cm	Sp. Mm
V01 05 72 G16	17,6x16,2	2	0,7
V01 05 72 G16A	17,6x16,2	4	0,7
V01 05 72 G16B	17,6x16,2	6,5	0,7
V01 05 72 G16C	17,6x16,2	10	0,7
V01 05 72 G16D	17,6x16,2	15	0,7
V01 05 72 G16E	17,6x16,2	20	0,7

**Contentore GN 1/9**

GN 1/9 container

Conteneur GN 1/9

GN Behälter Edelstahl Gn 1/9

Contenedor GN 1/9

Inox 18/10 - St. Steel

	Cm	H Cm	Sp. Mm
V01 05 72 G19A	17,6x10,8	4	0,7
V01 05 72 G19B	17,6x10,8	6,5	0,7
V01 05 72 G19C	17,6x10,8	10	0,7



Separatore GN

GN adaptor bars
GN Barrette de composition
Separator GN
Perfiles divisorios GN

Inox 18/10 - St. Steel

	GN
V01 05 72 SE 11	1/1
V01 05 72 SE 12	1/2



Falso fondo forato

False perforated bottom
Faux fond perforé
Flascher Boden mit Löchern
Falso hondo perforado

Inox 18/10 - St. Steel

	GN
V01 05 72 FF 21	2/1
V01 05 72 FF 11	1/1
V01 05 72 FF 23	2/3
V01 05 72 FF 12	1/2



Maniglia

Handle
Poignée
Griff
Manija

Inox 18/10 - St. Steel

Z01 10 72 FIV	maniglia fissa verticale
Z01 10 72 RIE	maniglia rientrante

Teglia GN 2/1

2/1 GN baking pan

Plat à four GN 2/1

Gastronorm-Blech Edelstahl GN 2/1

Fuente para horno GN 2/1

Inox 18/10 - St. Steel

	Cm	H Cm	Sp. Mm
V01 05 26 G21	65x53	2	0,7
V01 05 26 G21A	65x53	4	0,7
V01 05 26 G21B	65x53	6,5	0,7

**Teglia GN 1/1**

1/1 GN baking pan

Plat à four GN 1/1

Gastronorm-Blech Edelstahl GN 1/1

Fuente para horno GN 1/1

Inox 18/10 - St. Steel

	Cm	H Cm	Sp. Mm
V01 05 26 G110	53x32,5	1	0,7
V01 05 26 G11	53x32,5	2	0,7
V01 05 26 G11A	53x32,5	4	0,7
V01 05 26 G11B	53x32,5	6,5	0,7

**Teglia GN 1/2**

1/2 GN baking pan

Plat à four GN 1/2

Gastronorm-Blech Edelstahl GN 1/2

Fuente para horno GN 1/2

Inox 18/10 - St. Steel

	Cm	H Cm	Sp. Mm
V01 05 26 G12	32,5x26,5	2	0,7
V01 05 26 G12A	32,5x26,5	4	0,7
V01 05 26 G12B	32,5x26,5	6,5	0,7

**Teglia GN 2/3**

2/3 GN baking pan

Plat à four GN 2/3

Gastronorm-Blech Edelstahl GN 2/3

Fuente para horno GN 2/3

Inox 18/10 - St. Steel

	Cm	H Cm	Sp. Mm
V01 05 26 G23	35,4x32,5	2	0,7
V01 05 26 G23A	35,4x32,5	4	0,7
V01 05 26 G23B	35,4x32,5	6,5	0,7



Coperchio GN

GN lid
Couvercle GN
GN Deckel
Tapa GN



Inox 18/10 - St. Steel

	GN	Cm	Sp. Mm
V01 05 15 G11	1/1	53x32,5	0,7
V01 05 15 G23	2/3	35,4x32,5	0,7
V01 05 15 G12	1/2	32,5x26,5	0,7
V01 05 15 G13	1/3	32,5x17,6	0,7
V01 05 15 G14	1/4	26,5x16,2	0,7
V01 05 15 G16	1/6	17,6x16,2	0,7
V01 05 15 G19	1/9	17,6x10,8	0,7
V01 05 15 G24	2/4	16,2x53	0,7

Con asola/with hole

	GN	Cm	Sp. Mm
V01 05 15 GM11	1/1	53x32,5	0,7
V01 05 15 GM12	1/2	32,5x26,5	0,7
V01 05 15 GM13	1/3	32,5x17,6	0,7
V01 05 15 GM14	1/4	26,5x16,2	0,7
V01 05 15 GM16	1/6	17,6x16,2	0,7
V01 05 15 GM19	1/9	17,6x10,8	0,7
V01 05 15 GM23	2/3	35,4x32,5	0,7
V01 05 15 GM24	2/4	16,2x53	0,7



Cooperchio con guarnizione in silicone

	GN	Cm	Sp. Mm
V010515GG11	1/1	53x32,5	0,7
V010515GG23	2/3	35,4x32,5	0,7
V010515GG12	1/2	32,5x26,5	0,7
V010515GG13	1/3	32,5x17,6	0,7
V010515GG14	1/4	26,5x16,2	0,7
V010515GG16	1/6	17,6x16,2	0,7



Vaschetta gelato GN

GN ice cream pan

Bac à glace GN

Eisschale GN

Cubeta helado GN

Inox 18/10 - St. Steel

	Cm	H Cm
V01 05 72 IO 412	16,5x36	12

Bacinella forata (fondo + lati)

Perforated basin (bottom + sides)

Bacs perforè (fond + côtés)

Schüssel mit Löchern (Boden + Seiten)

Bandejas honda perforada (fondo y lados)

Inox 18/10 - St. Steel

	H Cm	H In	GN
V01 05 72 GF 11BL	6,5	2,1/2	1/1
V01 05 72 GF 11C	10	4	1/1
V01 05 72 GF 11D	15	6	1/1
V01 05 72 GF 11E	20	7,7/8	1/1
V01 05 72 GF 12C	10	4	1/2
V01 05 72 GF 12D	15	6	1/2
V01 05 72 GF 12E	20	7,7/8	1/2

**Bacinella forata (solo fondo)**

Perforated basin (bottom only)

Bacs perforè (fond seulement)

Schüssel mit Löchern (nur Boden)

Bandejas honda perforada (solo el fondo)

Inox 18/10 - St. Steel

	H Cm	H In	GN
V01 05 72 GF 21	2	0,3/4	2/1
V01 05 72 GF 21A	4	1,1/2	2/1
V01 05 72 GF 21B	6,5	2,1/2	2/1
01 05 72 GF 11	2	0,3/4	1/1
V01 05 72 GF 11A	4	1,1/2	1/1
V01 05 72 GF 11B	6,5	2,1/2	1/1
V01 05 72 GF 12	2	0,3/4	1/2
V01 05 72 GF 12A	4	1,1/2	1/2
V01 05 72 GF 12B	6,5	2,1/2	1/2
V01 05 72 GF 13	2	0,3/4	1/3
V01 05 72 GF 13A	4	1,1/2	1/3
V01 05 72 GF 13B	6,5	2,1/2	1/3
V01 05 72 GF 23	2	0,3/4	2/3
V01 05 72 GF 23A	4	1,1/2	2/3
V01 05 72 GF 23B	6,5	2,1/2	2/3



Contentore GN 2/1

GN 2/1 container
 Conteneur GN 2/1
 GN Behälter GN 2/1
 Contenedor GN 2/1

Policarbonato - Polycarbonate

	Cm	H Cm
V01 PC 72 G11 E	65x53	20



Contentore GN 1/1

GN 1/1 container
 Conteneur GN 1/1
 GN Behälter GN 1/1
 Contenedor GN 1/1

Policarbonato - Polycarbonate

	Cm	H Cm
V01 PC 72 G11 B	53x32,5	6,5
V01 PC 72 G11 C	53x32,5	10
V01 PC 72 G11 D	53x32,5	15
V01 PC 72 G11 E	53x32,5	20



Contentore GN 1/2

GN 1/2 container
 Conteneur GN 1/2
 GN Behälter GN 1/2
 Contenedor GN 1/2

Policarbonato - Polycarbonate

	Cm	H Cm
V01 PC 72 G12 B	32,5x26,5	6,5
V01 PC 72 G12 C	32,5x26,5	10
V01 PC 72 G12 D	32,5x26,5	15
V01 PC 72 G12 E	32,5x26,5	20



Contentore GN 1/3

GN 1/3 container
 Conteneur GN 1/3
 GN Behälter GN 1/3
 Contenedor GN 1/3

Policarbonato - Polycarbonate

	Cm	H Cm
V01 PC 72 G13 B	32,5x17,6	6,5
V01 PC 72 G13 C	32,5x17,6	10
V01 PC 72 G13 D	32,5x17,6	15
V01 PC 72 G13 E	32,5x17,6	20



Contenitore GN 1/4

GN 1/4 container
 Conteneur GN 1/4
 GN Behälter GN 1/4
 Contenedor GN 1/4

Policarbonato - Polycarbonate

	Cm	H Cm
V01 PC 72 G14 B	26,5x16,2	6,5
V01 PC 72 G14 C	26,5x16,2	10
V01 PC 72 G14 D	26,5x16,2	15
V01 PC 72 G14 E	26,5x16,2	20

**Contenitore GN 1/6**

GN 1/6 container
 Conteneur GN 1/6
 GN Behälter GN 1/6
 Contenedor GN 1/6

Policarbonato - Polycarbonate

	Cm	H Cm
V01 PC 72 G16 B	17,6x16,2	6,5
V01 PC 72 G16 C	17,6x16,2	10
V01 PC 72 G16 D	17,6x16,2	15
V01 PC 72 G16 E	17,6x16,2	20

**Contenitore GN 1/9**

GN 1/9 container
 Conteneur GN 1/9
 GN Behälter GN 1/9
 Contenedor GN 1/9

Policarbonato - Polycarbonate

	Cm	H Cm
V01 PC 72 G19 B	17,6x10,8	6,5
V01 PC 72 G19 C	17,6x10,8	10

**Vaschetta gelato GN**

GN ice cream pan
 Bac à glace GN
 Eisschale GN
 Cubeta helado GN

Policarbonato - Polycarbonate

	Cm	H Cm
V01 PC 72 GGE	16,5x36	12



Coperchio

Lid
Couvercle
Deckel
Tapa

Policarbonato - Polycarbonate

	Cm	GN
V01 PC 15 G21	65x53	2/1
V01 PC 15 G11	53x32,5	1/1
V01 PC 15 G12	32,5x26,5	1/2
V01 PC 15 G13	32,5x17,6	1/3
V01 PC 15 G14	26,5x16,2	1/4
V01 PC 15 G16	17,6x16,2	1/6
V01 PC 15 G19	17,6x10,8	1/9



Coperchio GN ermetico

GN hermetic lid
Couvercle hermétique GN
Hermetische Deckel GN
Tapa GN hermética

Policarbonato - Polycarbonate

	GN	Cm
V01 PC 15 GE11	1/1	53x32,5
V01 PC 15 GE12	1/2	32,5x26,5
V01 PC 15 GE13	1/3	32,5x17,6
V01 PC 15 GE14	1/4	26,5x16,2
V01 PC 15 GE16	1/6	17,6x16,2
V01 PC 15 GE19	1/9	17,6x10,8



Coperchio

Lid
Couvercle
Deckel
Tapa

Polipropilene - Polypropylene

	Cm	GN
V01 PP 15 G11	53x32,5	1/1
V01 PP 15 G12	32,5x26,5	1/2
V01 PP 15 G13	32,5x17,6	1/3
V01 PP 15 G14	26,5x16,2	1/4
V01 PP 15 G16	17,6x16,2	1/6
V01 PP 15 G19	17,6x10,8	1/9



Contentore GN 1/1

GN 1/1 container
 Conteneur GN 1/1
 GN Behälter Gn 1/1
 Contenedor GN 1/1

Polipropilene - Polypropylene

	Cm	H Cm
V01 PP 72 G11 B	53x32,5	6,5
V01 PP 72 G11 C	53x32,5	10
V01 PP 72 G11 D	53x32,5	15
V01 PP 72 G11 E	53x32,5	20

**Contentore GN 1/2**

GN 1/2 container
 Conteneur GN 1/2
 GN Behälter Gn 1/2
 Contenedor GN 1/2

Polipropilene - Polypropylene

	Cm	H Cm
V01 PP 72 G12 B	32,5x26,5	6,5
V01 PP 72 G12 C	32,5x26,5	10
V01 PP 72 G12 D	32,5x26,5	15
V01 PP 72 G12 E	32,5x26,5	20

**Contentore GN 1/3**

GN 1/3 container
 Conteneur GN 1/3
 GN Behälter Gn 1/3
 Contenedor GN 1/3

Polipropilene - Polypropylene

	Cm	H Cm
V01 PP 72 G13 B	32,5x17,6	6,5
V01 PP 72 G13 C	32,5x17,6	10
V01 PP 72 G13 D	32,5x17,6	15
V01 PP 72 G13 E	32,5x17,6	20

**Contentore GN 1/4**

GN 1/4 container
 Conteneur GN 1/4
 GN Behälter Gn 1/4
 Contenedor GN 1/4

Polipropilene - Polypropylene

	Cm	H Cm
V01 PP 72 G14 B	26,5x16,2	6,5
V01 PP 72 G14 C	26,5x16,2	10
V01 PP 72 G14 D	26,5x16,2	15
V01 PP 72 G14 E	26,5x16,2	20



Contentore GN 1/6

GN 1/6 container
 Conteneur GN 1/6
 GN Behälter Gn 1/6
 Contenedor GN 1/6

Polipropilene - Polypropylene

	Cm	H Cm
V01 PP 72 G16 B	17,6x16,2	6,5
V01 PP 72 G16 C	17,6x16,2	10
V01 PP 72 G16 D	17,6x16,2	15
V01 PP 72 G16 E	17,6x16,2	20

**Contentore GN 1/9**

GN 1/9 container
 Conteneur GN 1/9
 GN Behälter Gn 1/9
 Contenedor GN 1/9

Polipropilene - Polypropylene

	Cm	H Cm
V01 PP 72 G19 B	17,6x10,8	6,5
V01 PP 72 G19 C	17,6x10,8	10

**Vaschetta gelato GN**

GN ice cream pan
 Bac à glace GN
 Eisschale, übereinander legbar
 Cubeta helado GN

Polipropilene - Polypropylene

	Cm	H Cm
V01 PP 72 GGE	16,5x36	12

**Falso fondo forato**

False perforated bottom
 Faux fond perforé
 Flascher Boden mit Löchern
 Falso hondo perforado

Polipropilene - Polypropylene

	GN
V01 PP 72 FF11	1/1
V01 PP 72 FF12	1/2
V01 PP 72 FF13	1/3
V01 PP 72 FF16	1/6

Trinciapollo manico pom rivettato

Shears, pom riveted handle

Ciseaux à volailles manche POM riveté

Geflügel Schere mit genietetem Heft

Tijeras para aves mango pom remachado

Acciaio inossidabile - St. Steel

AVARI 110

**Trinciapollo manico cavo**

Shears, hollow handle

Tijeras para aves mango hueco

Geflügel Schere mit hohem Heft

Ciseaux à volailles manche creuse

Acciaio Inox AISI 420

AVARI 111

**Spillone pizzeria**

Pizza pin

Épingle pour commandes pizzeria

Pizzeria Stecknadel

Agujón para hojas pedidos pizzeria

Acciaio inossidabile - St. Steel

AVARI 086

**Campanello reception**

Reception bell

Sonette de réception

Hotelglocke

Timbre recepción

Acciaio inossidabile - St. Steel

AVARI 112



Schiumarola unipezzo

Skimmer, one piece
 Ecumoire en une pièce
 Schaumlöffel einteilig
 Espumadera de una sola pieza

Acciaio inossidabile - St. Steel

	∅ Cm	∅ In
903 06 81 US1	11	4,3/8
903 06 81 US3	13	5,1/8

**Mestolo unipezzo**

Soup, one piece
 Louche en une pièce
 Schopflöffel einteilig
 Cazo sopa de una sola pieza

Acciaio inossidabile - St. Steel

	∅ Cm	∅ In
903 06 81 UM9	9	3,1/2
903 06 81 UM1	10	4

**Mestolino unipezzo**

Sauce ladle, one piece
 Louche à sauce en une pièce
 Schopflöffel klein einteilig
 Cacillo salsa de una sola pieza

Acciaio inossidabile - St. Steel

	L Cm	L In
903 06 81 UMS	28	11

**Pala fritto unipezzo**

Frying palette, one piece
 Pelle frittura en une pièce
 Schaufel einteilig
 Pala frito de una sola pieza

Acciaio inossidabile - St. Steel

	L Cm	L In
903 06 81 UFR	36,5	14,3/8

**Cucchiaione unipezzo**

Serving spoon, one piece
 Cuillère à servir en une pièce
 Löffel einteilig
 Cucharón servir de una sola pieza

Acciaio inossidabile - St. Steel

	L Cm	L In
903 06 81 UCU	40	15,3/4

**Forchettone unipezzo**

Serving fork, one piece
 Fourchette à servir en une pièce
 Gabel einteilig
 Tenedor servir de una sola pieza

Acciaio inossidabile - St. Steel

	L Cm	L In
903 06 81 UFO	36	14,1/8



Molla ghiaccio deluxe

De luxe ice tongs
Pince à glaçons de luxe
Eiszange de luxe
Pinzas hielo de luxe

Acciaio inossidabile - St. Steel

	Cm	In
903 06 81 MGD	15,6	6,1/8

**Molla pane**

Bread tongs
Pince à pain
Brotzange
Pinzas pan

Acciaio inossidabile - St. Steel

	Cm	In
903 06 81 MPA	20	7,7/8

**Molla spaghetti**

Spaghetti tongs
Pince à spaghetti
Spaghetizange
Pinzas spaghetti

Acciaio inossidabile - St. Steel

	Cm	In
903 06 81 MSP	20,2	7,7/8

**Molla dolci**

Cake tongs
Pince à gâteau
Gebäckzange
Pinzas postre

Acciaio inossidabile - St. Steel

	Cm	In
903 06 81 MDL	18,9	7,1/2

**Molla arrosto**

Roast tongs
Pince à rôti
Fleisch/Servierzange
Pinzas asado

Acciaio inossidabile - St. Steel

	Cm	In
903 06 81 MAR	21	8,1/4

**Molla universale**

Universal tongs
Pince universelle
Universalzange
Pinzas universales

Acciaio inossidabile - St. Steel

	Cm	In
903 06 81 MUN	23,5	9,1/4



Molla zucchero

Sugar tongs
Pince à sucre
Zuckerzange
Pinzas azucar

Acciaio inossidabile - St. Steel

	Cm	In
903 06 81 MZU	14,1	5,1/2

**Molla ghiaccio piccola**

Small ice tongs
Pince à glaçons petite
Eiszange - klein
Pinzas hielo pequeñas

Acciaio inossidabile - St. Steel

	Cm	In
903 06 81 MGP	11,8	4,3/4

**Forbici insalata**

Salad tongs (scissors type)
Pince ciseaux à salade
Salatzange
Pinzas ensalada tipo tijeras

Acciaio inossidabile - St. Steel

	Cm	In
903 06 81 FIN	20	7,7/8

**Forbici dolci**

Cake tongs (scissors type)
Pince ciseaux à gâteaux
Scherenzange
Pinzas postre tipo tijeras

Acciaio inossidabile - St. Steel

	Cm	In
903 06 81 FDO	19,5	7,5/8

**Molla gastronomica**

Culinary tongs
Pince culinaire
Gastronomischer Frühling
Pinzas culinario

Inox 18/10 - St. Steel

	Mm	In
CI 180 00	155	6,1/8

**Molla affettati**

Salami tongs
Pince charcuterie
Wurstwarenfeder
Pinzas charcutería

Acciaio inossidabile - St. Steel

	Mm	In
903 05 81 MAF C1	105	4,1/8





Bastardella

Bowl
Bol
Edelstahl 18/10 Schale "Bastardella"
Bol

Acciaio Inox 18/10 - St.steel

	∅ Cm	H Cm	∅ In	H In
V01 05 43 B 26	26	16,2	10,1/4	6,1/4
V01 05 43 B 22	22	16,2	8,5/8	6,1/4



Supporto per bastardella

Bowl stand
Support pour bol
Halter für Schale
Soparte para bol

Acciaio Inox 18/10 - St.steel

	∅ Cm	H Cm	∅ In	H In
Z01 19 43 B 22	16	3	6,1/4	1,1/8



Ciotola Imperial

Bowl
Bol
Bol
Schale

Inox 18/10 - St. Steel

	Cm	In
V01 05 43 I16	16	6,1/4
V01 05 43 I18	18	7
V01 05 43 I20	20	7,7/8
V01 05 43 I22	22	8,5/8
V01 05 43 I24	24	9,1/2
V01 05 43 I28	28	11
V01 05 43 I32	32	12,5/8



Ciotola

Bowl
Bol
Bol
Schale

Inox 18/10 - St. Steel

	ø Cm	ø In	Lt
AVARI 049	12	4,3/4	0,5
AVARI 052	16	6,1/4	1
AVARI 050	20	7,7/8	2
AVARI 053	23	9,8/8	3
AVARI 051	26	10,1/4	4
AVARI 054	29	11,1/2	5,5



Carapina Professionale

Ice cream professional container
Conteneur à glace professionnel
Contenedor helado profesional
Eis Behälter, profi

Inox 18/10 - St. Steel

	ø Cm	H Cm	ø In	H In
V01 05 72 GGE	20	23,5	7,7/8	9,1/4



Vassoio pasticceria

Confectionery tray
Plateau à pâtisserie
Konditoreiplatte
Bandeja p/pasteleria

Inox 18/10 - St. Steel

	Cm	In
CI 5601	25x18	9,7/8x7
CI 5602	30x22	11,3/4x8,5/8



Lasagnera

Lasagna tray
Plat à four
Lasagnepfanne
Lasañera

Inox 18/10 - St. Steel

	Cm	In
V03 06 26 026	26,5x19,5	10,3/8x7,5/8
V03 06 26 031	31,5x24	12,3/8x9,1/2
V03 06 26 037	37x27	14,1/2x10,5/8
V03 06 26 040	42x30,5	16,1/2x12







abert BY Promab

Mestolo

Ladle
Louche
Suppenlöffel
Cazo

Nylon PA 6,6 FG 10%

	Cm	In
● 903 12 81 C15 ME	32	12,5/8
● 903 12 81 C47 ME	32	12,5/8

**Schiumarola**

Skimmer
Ecumoire
Schaumlöffel
Espumadera

Nylon PA 6,6 FG 10%

	Cm	In
● 903 12 81 C15 SC	35	13,3/4
● 903 12 81 C47 SC	35	13,3/4

**Pala fritto**

Frying shovel
Pelle à friture
Schaufel
Pala para freir

Nylon PA 6,6 FG 10%

	Cm	In
● 903 12 81 C15 FR	35	13,3/4
● 903 12 81 C47 FR	35	13,3/4

**Paletta**

Showel
Pelle
Schaufel
Pala

Nylon PA 6,6 FG 10%

	Cm	In
● 903 12 81 C15 PA1	35	13,3/4
● 903 12 81 C47 PA1	35	13,3/4

**Cucchiaine forato**

Slotted spoon
Cuillère à servir perforée
Gelochte Servierlöffel
Cucharòn perforado

Nylon PA 6,6 FG 10%

	Cm	In
● 903 12 81 C15 CUF	35	13,3/4
● 903 12 81 C47 CUF	35	13,3/4

**Cucchiaine**

Serving spoon
Cuillère à servir
Servierlöffel
Cucharòn

Nylon PA 6,6 FG 10%

	Cm	In
● 903 12 81 C15 CU	35	13,3/4
● 903 12 81 C47 CU	35	13,3/4



Servispaghetti

Spaghetti serving spoon
Louche à spaghetti
Servierlöffel für Spaghetti
Cucharón para spaghetti

Nylon PA 6,6 FG 10%

	Cm	In
● 903 12 81 C15 SP	33,4	13,1/4
● 903 12 81 C47 SP	33,4	13,1/4



Paletta

Shovel
Pelle
Schaufel
Pala

Nylon PA 6,6 FG 10%

	Cm	In
● 903 12 81 C15 PA2	32	12,5/8
● 903 12 81 C47 PA2	32	12,5/8



Paletta forata

Perforated shovel
Pelle perforée
Gelochte Schaufel
Pala perforada

Nylon PA 6,6 FG 10%

	Cm	In
● 903 12 81 C15 PAF	31,5	12,3/8
● 903 12 81 C47 PAF	31,5	12,3/8



Paletta fritto

Frying shovel
Pelle à friture
Schaufel
Pala para freir

Nylon PA 6,6 FG 10%

	Cm	In
● 903 12 81 C15 PAA	32	12,5/8
● 903 12 81 C47 PAA	32	12,5/8



Pinza chef

Chef tongs
Pince chef
Chef Zange
Pinzas de chef

Nylon PA 6,6 FG 10%

	Cm	In
● 903 12 81 C15 PI	30,5	12
● 903 12 81 C47 PI	30,5	12



Paletta scolatutto

Draining spoon
Cuillère à égoutter
Schaumschaufel
Cuchara para colar

Nylon PA 6,6 FG 10%

	Cm	In
● 903 12 81 C15 PFG	38	15
● 903 12 81 C47 PFG	38	15



Molla toast/dolce

Toast/cake tongs
 Pince à gâteaux
 Kuchenschaufel
 Pinzas postre

Nylon PA 6,6 FG 10%

	Cm	In
● 903 12 81 C15 MD	28	11
● 903 12 81 C47 MD	28	11

**Molla insalata**

Salad tongs
 Pince à salade
 Salatschaufel
 Pinzas ensalad

Nylon PA 6,6 FG 10%

	Cm	In
● 903 12 81 C15 MI	31	12,1/4
● 903 12 81 C47 MI	31	12,1/4



Padella 1 manico

Frying pan, 1-handle
Poêle avec 1 manches
Mit Griff Pfanne
Sartén un mangos

Alluminio con fondo a induzione
Aluminium with induction bottom

	∅ Cm	∅ In	H Cm	H In
V67 11 72 PA24	24	9,1/2	6	2,3/8
V67 11 72 PA28	28	11	7	2,3/4
V67 11 72 PA32	32	12,5/8	7,5	3
V67 11 72 PA36	36	14,1/8	8	3,1/8
V67 11 72 PA40	40	15,3/4	8,5	3,3/8



Pentola 2 manici

Pot, 2-handle
Casserole avec 2 manches
Mit 2 Griffen Topf
Olla dos mangos

Alluminio con fondo a induzione
Aluminium with induction bottom

	∅ Cm	∅ In	H Cm	H In	Lt	Oz
V67 11 72 PE28	28	11	15	6	8	270
V67 11 72 CA32	32	12,5/8	11,5	4,1/2	9	304

casseruola | casserole



Tegame 2 manici

Frying pan, 2 - handle
Poêlon avec 2 manches
Mit 2 Griffen Flache Kochtopf
Olla dos mangos

Alluminio con fondo a induzione
Aluminium with induction bottom

	∅ Cm	∅ In	H Cm	H In
V67 11 72 TE24	24	9,1/2	6	2,3/8
V67 11 72 TE28	28	11	7	2,3/4
V67 11 72 TE32	32	12,5/8	7,5	3
V67 11 72 TE36	36	14,1/8	8	3,1/8
V67 11 72 TE40	40	15,3/4	8,5	3,3/8



Wok antiaderente

Wok, non-stick
Wok anti-adhésif
Wok mit einem Griff
Wok antiadherente

Alluminio con fondo a induzione
Aluminium with induction bottom

	ø Cm	ø In	H	Hin
V68 11 72 WO 26	26	10,1/4	7,8	3
V68 11 72 WO 28	28	11	7,8	3
V68 11 72 WO 30	30	11,3/4	8,8	3,1/2

**Casseruola 2 manici**

Casserole, 2-handle
Casserole à 2 manches
Kasserolle mit 2 Griffen
Cacerola 2 mangos

Alluminio con fondo a induzione
Aluminium with induction bottom

	ø Cm	ø In	H Cm	H in	lt
V68 11 72 CA 20A	20	7,7/8	8,8	3,1/2	2,8
V68 11 72 CA 22	22	8,5/8	9,2	3,1/2	3,5
V68 11 72 CA 24	24	9,1/2	10,7	4,1/8	4,8
V68 11 72 CA 26	26	10,1/4	11,8	4,3/4	6,2
V68 11 72 CA 28	28	11	12	4,3/4	7,4
V68 11 72 CA 32	32	12,5/8	12	4,3/4	9,5

**Casseruola 1 manico**

Casserole, 1-handle
Casserole à 1 manche
Kasserolle mit einem Griff
Cacerola 1 mango

Alluminio con fondo a induzione
Aluminium with induction bottom

	ø Cm	ø In	H Cm	H in	lt
V68 11 72 2CA 14	14	5,1/2	7	2,3/4	1
V68 11 72 2CA 16	16	6,1/4	8	3,1/8	1,6
V68 11 72 2CA 18	18	7	8,8	3,1/2	2,2
V68 11 72 2CA 20	20	7,7/8	8,8	3,1/2	2,8



Padella antiaderente 1 manico

Frying pan, non-stick 1-handle
Poêle antiadhérente avec 1 manches
Mit Griff Pfanne
Sartén antiadherente un mangos

Alluminio con fondo a induzione
Aluminium with induction bottom

	∅ Cm	∅ In	H Cm	H In
V68 11 72 PA20	20	7,7/8	4,3	1,3/4
V68 11 72 PA22	22	8,5/8	4,3	1,3/4
V68 11 72 PA24	24	9,1/2	6	2,3/8
V68 11 72 PA28	28	11	7	2,3/4
V68 11 72 PA32	32	12,5/8	7,5	3
V68 11 72 PA36	36	14,1/8	8	3,1/8
V68 11 72 PA40	40	15,3/4	8,5	3,3/8



Pentola antiaderente 2 manici

Pot, non-stick 2-handle
Casserole antiadhérente avec 2 manches
Mit 2 Griffen Topf
Olla antiadherente dos mangos

Alluminio con fondo a induzione
Aluminium with induction bottom

	∅ Cm	∅ In	H Cm	H In	Lt	Oz
V68 11 72 PE28	28	11	15	6	8	270



Tegame antiaderente 2 manici

Pot, non stick 2 - handle
Casserole antiadhérente avec 2 manches
Mit 2 Griffen Flache Kochtopf
Olla antiadherente dos mangos

Alluminio con fondo a induzione
Aluminium with induction bottom

	∅ Cm	∅ In	H Cm	H In
V68 11 72 TE24	24	9,1/2	6	2,3/8
V68 11 72 TE28	28	11	7	2,3/4
V68 11 72 TE32	32	12,5/8	7,5	3
V68 11 72 TE36	36	14,1/8	8	3,1/8
V68 11 72 TE40	40	15,3/4	8,5	3,3/8



Coltello chef

Chef knife
Couteau chef
Chefmesser
Cuchillo cocinero

Acciaio inossidabile - St. Steel+ ABS

	Cm	In
V67 06 91 001	15	6
V67 06 91 002	20	7,7/8
V67 06 91 025	23	9
V67 06 91 026	25	9,7/8

**Coltello pane**

Bread knife
Couteau pain
Brottmesser
Cuchillo pan

Acciaio inossidabile - St. Steel+ ABS

	Cm	In
V67 06 91 003	20	7,7/8

**Coltello affettare**

Slicing knife
Couteau pour coupe en tranches
Messer zum Aufschneiden
Cuchillo para filetear

Acciaio inossidabile - St. Steel+ ABS

	Cm	In
V67 06 91 004	20	7,7/8

**Coltello utility**

Utility knife
Couteau de service
Utility-Messer
Cuchillo universal

Acciaio inossidabile- St. Steel+ ABS

	Cm	In
V67 06 91 009	14	5,1/2

**Coltello santoku**

Santoku knife
Couteau Santoku
Santoku Profimesser
Cuchillo Santoku

Acciaio inossidabile - St. Steel+ ABS

	Cm	In
V67 06 91 005	12,5	5
V67 06 91 006	18	7

**Coltello disossare**

Boning knife
Couteau à désosser
Messer zum Entbeinen
Cuchillo deshuesador

Acciaio inossidabile - St. Steel+ ABS

	Cm	In
V67 06 91 007	16	6,1/4



Mannaretta

Cleaver
Couperet
Hackbeil Messer
Cuchillo de carnicero

Acciaio inossidabile - St. Steel+ ABS

	Cm	In
V67 06 91 027	18	7



Affilacoltelli professionale

Professional sharpener
Aiguiseur à couteaux
Schleifmittel
Afilador de cuchillos

Acciaio inossidabile - St. Steel+ ABS

	Cm	In
V67 06 91 012	20	7,7/8



Coltello professionale Utility

Professional Utility knife
Couteau de service dentelé
Utility-Messer
Cuchillo universal dentado

Acciaio inossidabile - St. Steel+ ABS

	Cm	In
V67 06 91 008	11,5	4,1/2



Coltello spelucchino

Paring knife
Couteau à éplucher
Schälmesser
Cuchillo guarnecer

Acciaio inossidabile - St. Steel+ ABS

	Cm	In
V67 06 91 010	8,8	3,1/2



Coltello professionale frutta

Professional fruit knife
Couteau à fruits
Obstmesser
Cuchillo frutas

Acciaio inossidabile - St. Steel+ ABS

	Cm	In
V67 06 91 011	8,8	3,1/2



Cestino pane

Square bread basket
Corbeille à pain carré
Viereckiger Brotkorb
Cesta pan cuadrado

	Cm	H Cm	In	H In
Marrone - Brown				
AVARI 200	14x14	8	5,1/2x5,1/2	3,1/8
AVARI 203	19x19	10	7,1/2x7,1/2	4
Beige - Ecrù				
AVARI 201	14x14	8	5,1/2x5,1/2	3,1/8
AVARI 204	19x19	10	7,1/2x7,1/2	4
Juta - Juta				
AVARI 202	14x14	8	5,1/2x5,1/2	3,1/8
AVARI 205	19x19	10	7,1/2x7,1/2	4

**Cestino portabustine mignon**

Tea/Sugar bag basket, small
Corbeille à sachets de thé/sucre petite
Klein Stoffkorb, Tee und Zuckerbeutelbehälter
Cestita para bolsitas de té/azúcar pequeña

	Cm	H Cm	In	H In
Marrone - Brown				
AVARI 208	6x8	6	2,3/8x3,1/8	2,3/8
Beige - Ecrù				
AVARI 209	6x8	6	2,3/8x3,1/8	2,3/8
Juta				
AVARI 210	6x8	6	2,3/8x3,1/8	2,3/8

**Sacchetto porta pane**

Bread basket
Corbeille à pain
Brotkorb
Cesta pan

	ø Cm	H Cm	ø In	H In
Marrone - Brown				
AVARI 206	21	25	8,1/4	9,7/8
Beige - Ecrù				
AVARI 207	21	25	8,1/4	9,7/8

**Cuscino termico**

Thermal cushion
Coussin chauffant
Wärmekissen
Cojín térmico

	Cm	In
325 05 24 579	13x13	5,1/8x5,1/8
325 05 24 580	18x18	7x7



Cestino pane

Bread basket
Corbeille à pain
Brotkorb
Cesta pan

	Cm	H Cm	In	H In
Marrone - Brown				
305 29 24 581	12x12	14,5	5x5	5,3/4
305 29 24 582	18x18	18	7x7	7
Beige - Ecrù				
305 29 24 583	12x12	14,5	5x5	5,3/4
305 29 24 584	18x18	18	7x7	7



Cuscino termico

Thermal cushion
Coussin chauffiant
Wärmekissen
Cojín térmico

	Cm	In
325 05 24 579	13x13	5,1/8x5,1/8
325 05 24 580	18x18	7x7

Cestino pane tessuto con cuscino

Bread basket with cushion
Corbeille à pain avec coussin
Brotkorb mit Kissen
Cesta pan con cosin

	Cm	H Cm	In	H In
Marrone - Brown				
AVARI 151	12x12	14,5	5x5	5,3/4
AVARI 153	18x18	18	7x7	7
Beige - Ecrù				
AVARI 150	12x12	14,5	5x5	5,3/4
AVARI 152	18x18	18	7x7	7



Cestino pane tessuto (senza cuscino)

Bread basket (without cushion)
Corbeille à pain (sans coussin)
Brotkorb (ohne Kissen)
Cesta pan (sin cosin)

	Cm	H Cm	In	H In	Pz - Pcs
Marrone - Brown					
AVARI 162	12x12	14,5	5x5	5,3/4	1
AVARI 164	18x18	18	7x7	7	1
Beige - Ecrù					
AVARI 161	12x12	14,5	5x5	5,3/4	1
AVARI 163	18x18	18	7x7	7	1
Marrone - Brown					
AVARI 154	12x12	14,5	5x5	5,3/4	3
AVARI 156	18x18	18	7x7	7	2
Beige - Ecrù					
AVARI 155	12x12	14,5	5x5	5,3/4	3
AVARI 157	18x18	18	7x7	7	2



Brocca ColorStyle

ColorStyle jug
 Broc à eau ColorStyle
 Acryl Kanne Colorstyle
 Jarra ColorStyle

Acrilico / Acrilic

	Lt	Oz
<input type="checkbox"/> V60 12 08 001 13	2	70
<input checked="" type="checkbox"/> V60 12 08 001 00	2	70

**Brocca Diamond**

Diamond jug
 Broc à eau Diamond
 Acryl Kanne Diamond
 Jarra Diamond

Acrilico / Acrilic

	Lt	Oz
<input checked="" type="checkbox"/> V60 12 08 003 00	2,5	87,5

**Brocca Elegant**

Elegant jug
 Broc à eau Elegant
 Acryl Kanne Elegant
 Jarra Elegant

Acrilico / Acrilic

	Lt	Oz
<input checked="" type="checkbox"/> V60 12 08 004 00	2	70

**Caraffa ColorStyle**

ColorStyle Pitcher
 Carafe ColorStyle
 Acryl Karaffe Colorstyle
 Jarra ColorStyle

Acrilico / Acrilic

	Lt	Oz
<input type="checkbox"/> V60 12 08 002 13	1,5	50,7
<input checked="" type="checkbox"/> V60 12 08 002 47	1,5	50,7



Olierona

Oil dispenser
Huilière
Ölbehälter
Aceitera grande

Acciaio inossidabile - St. Steel

	Lt	Oz
AVARI 071	0,5	17,5
AVARI 072	1,0	35



Olierona con tappo versatore salvagoccia

Oil server with drop stop pourer
Huilier avec bouchon verseur anti-gouttes
Olivenölbehälter mit Eingießstöpsel, mit Tropfschutzverschluß
Aceitera con tapón vertedor antigoteo

Acciaio inox 18|10 / 18|10 St. Steel

	Lt	Oz
AVARI 400	0,25	9
AVARI 401	0,50	17,5
AVARI 402	0,75	26,5
AVARI 403	1,00	35



Secchio spumante 1 bottiglia

Champagne bucket, 1-bottle
 Seau à champagne 1 bouteille
 Champagneschale (Für 1Flasche)
 Cubo champán 1 botella

	Cm	H Cm	In	H In
V81 12 20 001 Plex -Transparent	22x16	23,5	8,5/8x6,1/4	9,1/4
V81 12 20 004 PS - Transparent	22x16	23,5	8,5/8x6,1/4	9,1/4
V81 12 20 007 PS Bianco - White	22x16	23,5	8,5/8x6,1/4	9,1/4

**Secchio spumante Magnum**

Magnum bucket
 Seau Magnum
 Champagneschale Magnum
 Cubo Magnum

	Cm	H Cm	In	H In
V81 12 20 002 Plex -Transparent	27,9x17,3	23,4	11x6,7/8	9,1/4
V81 12 20 005 PS - Transparent	27,9x17,3	23,4	11x6,7/8	9,1/4
V81 12 20 008 PS Bianco - White	27,9x17,3	23,4	11x6,7/8	9,1/4

**Secchio spumante Jeroboam**

Jeroboam bucket
 Seau Jeroboam
 Champagneschale Jeroboam
 Cubo Jeroboam

	Cm	H Cm	In	H In
V81 12 20 003 Plex -Transparent	48,2x20,9	24,3	19x8,1/4	9,5/8
V81 12 20 006 PS - Transparent	48,2x20,9	24,3	19x8,1/4	9,5/8
V81 12 20 009 PS Bianco - White	48,2x20,9	24,3	19x8,1/4	9,5/8



Runner - grigio scuro

Runner, dark grey
Chemin de table gris foncé
Runner dunkelgrau
Camino de mesa gris oscuro

70% Pvc - 30% Pet

	Cm	In
AVARI TO 31	45x120	17,3/4x47,2



Runner - grigio chiaro

Runner, light grey
Chemin de table gris clair
Runner hellgrau
Camino de mesa gris claro

70% Pvc - 30% Pet

	Cm	In
AVARI TO 30	45x120	17,3/4x47,2

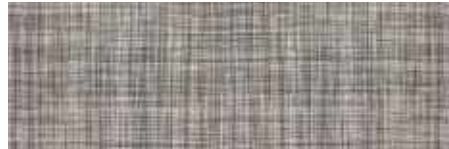

Runner - grigio tortora

Runner, taupe
Chemin de table taupe
Runner taubegrau
Camino de mesa gris topo

70% Pvc - 30% Pet

	Cm	In
AVARI TO 32	45x120	17,3/4x47,2



Runner - grigio sabbia

Runner, sand
Chemin de table sable
Runner sandgrau
Camino de mesa arena

70% Pvc - 30% Pet

	Cm	In
AVARI TO 33	45x120	17,3/4x47,2



Runner - grigio marrone con rettangolo

Runner, brown with rectangle
Chemin de table marron avec rectangle
Runner braungrau rechteckig
Camino de mesa marrón con rectángulo

70% Pvc - 30% Pet

	Cm	In
AVARI TO 34	45x120	17,3/4x47,2





Tovaglietta - marrone

Placemat - brown
Nappe individuelle marron
Klein Tischtuch braun
Mantel individual marròn

Pvc-Pet

	Cm	In
AVARITO 14	45x30	17,3/4x11,3/4



Tovaglietta - tortora quadrati

Placemat - taupe, squares
Nappe individuelle taupe carrés
KleinTischtuch grau mit quadraten
Mantel individual gris topo cuadrados

Pvc-Pet

	Cm	In
AVARITO 11	45x30	17,3/4x11,3/4



Tovaglietta - marrone quadrati

Placemat brown - squares
Nappe individuelle marron carrés
Klein Tischtuch braun mit Quadrat
Mantel individual marròn cuadrados

Pvc-Pet

	Cm	In
AVARITO 12	45x30	17,3/4x11,3/4



Tovaglietta - bianco

Placemat - white
Nappe individuelle blanc
Klein Tischtuch weiss
Mantel individual blanco

Pvc-Pet

	Cm	In
AVARITO 13	45x30	17,3/4x11,3/4



Tovaglietta - marrone

Placemat - brown
Nappe individuelle marron
Klein Tischtuch braun
Mantel individual marròn

Pvc-Pet

	Cm	In
AVARITO 10	45x30	17,3/4x11,3/4



Tovaglietta - grigio scuro

Placemat - dark grey
Nappe individuelle gris fouché
Klein Tischtuch dunkel grau
Mantel individual gris oscuro

Pvc-Pet

	Cm	In
AVARITO 01	45x30	17,3/4x11,3/4



Tovaglietta - grigio chiaro

Placemat- light grey
Nappe individuelle gris clair
Klein Tischtuch hellgrau
Mantel individual gris claro

Pvc-Pet

	Cm	In
AVARITO 02	45x30	17,3/4x11,3/4



Tovaglietta - tortora

Placemat - taupe
Nappe individuelle taupe
Klein Tischtuch grau
Mantel individual gris topo

Pvc-Pet

	Cm	In
AVARITO 03	45x30	17,3/4x11,3/4



Tovaglietta - beige/azzurro

Placemat - beige/blue
Nappe individuelle beige/bleue
Klein Tischtuch beige/hellblau
Mantel individual beige/azul claro

Pvc-Pet

	Cm	In
AVARITO 05	45x30	17,3/4x11,3/4

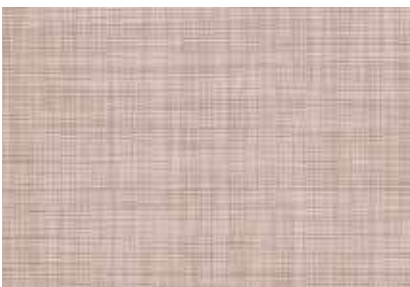

Tovaglietta - sabbia

Placemat - sand
Nappe individuelle sable
Klein Tischtuch sand
Mantel individual arena

Pvc-Pet

	Cm	In
AVARITO 07	45x30	17,3/4x11,3/4



Tovaglietta - marrone lavorato

Placemat - light brown - woven
Nappe individuelle marron tressée
Klein Tischtuch braun, gearbeitet
Mantel individual marrón tejido

Pvc-Pet

	Cm	In
AVARITO 08	45x30	17,3/4x11,3/4

Bivalva Roberta

Roberta blister, Italy

Blister Roberta Italy

Sichtbare Blase (ohne Bestecke)

Blister Roberta Italy

Acciaio inox 18|10 / 18|10 St. Steel

Cucchiaio tavola	F85 22 401	pcs 24
Forchetta tavola	F85 22 402	pcs 24
Coltello tavola	F85 21 205	pcs 12
Cucchiaino caffè	F85 24 821	pcs 48
Forchetta dolce	F85 23 638	pcs 36



Bivalva Corsaro

Corsaro blister, Italy
Blister Corsaro Italy
Sichtbare Blase (ohne Bestecke)
Blister Corsaro Italy

Acciaio inox 18|10 / 18|10 St. Steel

Set 24 pezzi LV1 BI 240F pcs 24



Rist & Bar Corsaro

Corsaro , Rist & Bar
 Rist & Bar Corsaro
 Rist & Bar Corsaro
 Rist & Bar Corsaro

Acciaio inox / St. Steel

Cucchiaio tavola Corsaro in GN 1/4	LV1 14B 6601	pcs 66
Forchetta tavola Corsaro in GN 1/4	LV1 14B 9602	pcs 96
Coltello tavola Corsaro in GN 1/4	LV1 14B 4805	pcs 48
Cucchiaino caffè Corsaro in GN 1/6	LV1 16B AT21	pcs 120
Cucchiaino caffè Corsaro in GN 1/9	LV1 19B BL22	pcs 150
Forchettina dolce Corsaro in GN 1/6	LV1 16B 9638	pcs 96



BARattoli

BARattoli
 BARattoli
 BARattoli
 BARattoli

Acciaio inox / St. Steel

Cucchiaini Moka	LV1 14B 6601	pcs 150
Cucchiaini Caffè	LV1 14B 9602	pcs 120
Palette Moka	LV1 14B 4805	pcs 180



Blister coltelli carne Rost punta

Rost steak knives blister
Blister de couteaux à viande Rost
Fleischmesser Rost Blisterpackung
Blister cuchillos carne Rost

AVARI 064B 06 pcs 6
AVARI 064B 12 pcs 12

**Blister coltelli carne Rost punta tonda**

Rost steak knives round point blister
Blister de couteaux à viande Rost pointe ronde
Fleischmesser Rost Blisterpackung
Blister cuchillos carne Rost

AVARI 064T B06 pcs 6
AVARI 064T B12 pcs 12

**Blister coltelli pizza Rost**

Pizza knives Rost blister
Blister de couteaux à pizza Rost
Rost Pizzamesser Blisterpackung
Blister cuchillos pizza Rost

AVARI 064P B06 pcs 6
AVARI 064P B12 pcs 12



Blister coltelli spelucchino Rost

Rost paring knives blister
Blister de couteau à éplucher Rost
Schälmesser Rost Blisterpackung
Blister Cuchillo guarnecer Rost

AVARI 064S B12 pcs 12



Blister pz.6 coltelli carne Arlecchino

Arlecchino steak knives 6-pc blister
Blister 6 pcs de couteaux à viande Arlecchino
6-teiliges Fleischmesser Arlecchino Blisterpackung
Blister 6 pzas cuchillos carne Arlecchino

Acciaio inox colori assortiti

	mm	In
● AVARI 047 47	211	8,1/4
● AVARI 047 07	211	8,1/4
○ AVARI 047 13	211	8,1/4
● AVARI 047 34	211	8,1/4
● AVARI 047 06	211	8,1/4
○ AVARI 047 19	211	8,1/4
● AVARI 047 14	211	8,1/4



Blister pz.6 coltelli carne Arlecchino punta tonda

Arlecchino steak knives round-point 6-pc blister
Blister 6 pcs de couteaux à viande Arlecchino pointe ronde
6-teiliges Fleischmesser Arlecchino Blisterpackung
Blister 6 pzas cuchillos carne Arlecchino con punta redonda

Acciaio inox colori assortiti

	mm	In
● AVARI 047T 47	211	8,1/4
● AVARI 047T 07	211	8,1/4
○ AVARI 047T 13	211	8,1/4
● AVARI 047T 34	211	8,1/4
● AVARI 047T 06	211	8,1/4
○ AVARI 047T 19	211	8,1/4
● AVARI 047T 14	211	8,1/4





THE INTERNATIONAL CERTIFICATION NETWORK

CERTIFICATE

SQS and IQNet Partner hereby states that the organization

Abert S.p.A.
Via Don P. Mazzolari, 17 (Zona Industriale)
25050 Passirano (BS)
Italia

for the following scope and type of activities

Divisione Abert
Sito di Via Don P. Mazzolari, 17, 25050 Passirano (BS)
Progettazione, fabbricazione e commercializzazione di posate, complementi per la tavola, vasellame, caffettiere e pentolame.

has implemented and maintains a
Management System
 which fulfills the requirements of the following standard(s)

ISO 9001:2015 / Quality Management System

for the validity date, please refer to the original certificate* issued by SQS

Scope No(s): 17
 Issued on: 2016-11-11
 Validity date: 2019-11-10
 Registration Number: **CH-30537**



Michael Drechsel
 Michael Drechsel
 President of IQNet



Roland Glauser
 Roland Glauser
 CEO SQS

IQNet Partners**:
 AENOR Spain AFNOR Certification France AIB Vinçotte International Belgium AFCEP Portugal CCC Cyprus
 CISO Italy CQC China CQM China CQS Czech Republic Cro Cert Croatia DQS Holding GmbH Germany
 FCAV Brazil FONDONORMA Venezuela ICONTEC Colombia IMC Mexico Inspecta Certification Finland INTECO Costa Rica
 IRAM Argentina IQA-India KPI Korea MITEC Greece MIST Hungary Nemko AS Norway NSAI Ireland PCBC Poland
 Quality Austria Astaris BR Russia SIGE Mexico SHI Israel SIQ Slovenia SIPIM QAS International Malaysia
 SQS Switzerland SRAC Romania TEST St Petersburg Russia TSE Turkey YUQS Serbia
 IQNet is represented in the USA by: AFNOR Certification, CISO, DQS Holding GmbH and NSAI Inc.

* This attestation is directly linked to the IQNet Partner's original certificate and shall not be used as a stand-alone document
 ** The list of IQNet partners is valid at the time of issue of this certificate. Updated information is available under www.iqnet-certification.com



Certificato

SQS attesta che l'azienda sotto indicata dispone di un sistema di management che soddisfa le esigenze della normativa indicata.



Via Don P. Mazzolari, 17 (Zona Industriale)
25050 Passirano (BS)
Italia

Campo d'applicazione

Divisione Abert
Sito di Via Don P. Mazzolari, 17, 25050 Passirano (BS)

Ambito d'attività

Progettazione, fabbricazione e commercializzazione di posate, complementi per la tavola, vasellame, caffettiere e pentolame.

Normativa base

ISO 9001:2015 **Sistema di gestione per la qualità**

Scope(s) 17

Validità 11.11.2016-10.11.2019
 Versione 11.11.2016

No. di reg. 30537

X. Edelmann
 X. Edelmann, Presidente SQS

R. Glauser
 R. Glauser, CEO SQS



Associazione Svizzera per Sistemi di Qualità e di Management SQS
 Bernstrasse 103, 3052 Zollikofen, Svizzera



Partner of

abert[®]

ABERT S.p.A.

Via Don P. Mazzolari, 17
25050 Passirano (Bs) Italy
T. 0306853611
F. 0306577194

info@abert.it
www.abert.it

HO.RE.CA.

20
19

abert[®]

abbert Promab

DALLA TAVOLA ALLA CUCINA | 2020

CUCINART P. 7

A TAVOLA P. 17

BAR COLAZIONE P. 29

CUCINA P. 39

ACCESSORI P. 57

COTTURE ANTIADERENTI P. 67

PENTOLE ACCIAIO P. 85

COTTURE SPECIALI P. 91



MESTOLAME
Kitchen Tools

PADELLA
Frying Pan

TEGAME
Saucepan

COLTELLI
Knives

CUCINART

**PADELLA 1 MANICO**

Frying pan, 1-handle

Antiaderente / Non-stick

	Ø Cm	H
V68 11 72 PA 20	20	4,3
V68 11 72 PA 22	22	4,3
V68 11 72 PA 24	24	6
V68 11 72 PA 28	28	7
V68 11 72 PA 32	32	7,5
V68 11 72 PA 36	36	8
V68 11 72 PA 40	40	8,5

**WOK ANTIADERENTE**

Wok, 1 handle

Antiaderente / Non-stick

	Ø Cm	H
V68 11 72 WO 26	26	7,8
V68 11 72 WO 28	28	7,8
V68 11 72 WO 30	30	8,8

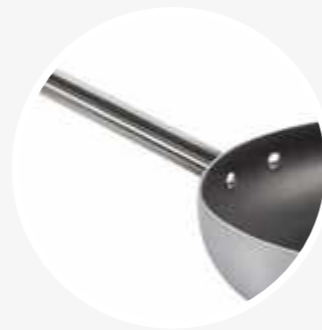
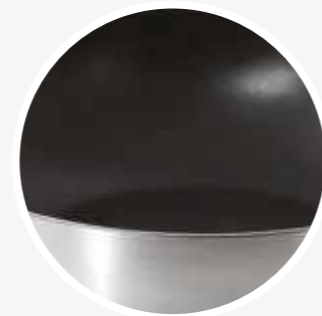
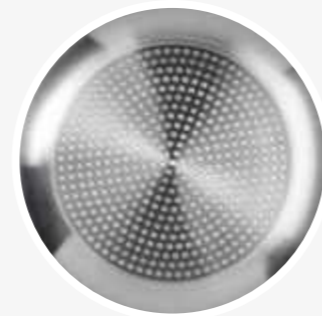
**MANICO IN ACCIAIO INOX**
stainless steel handle**ANTIADERENTE**
non-stick coating**IDONEO PER TUTTI I PIANI DI COTTURA**
compatible with all cooktops**CUCINART LINE**

In alluminio con interno antiaderente e manici in acciaio inox.

CUCINART LINE*Aluminum, non-stick inside with stainless steel handles. The bottom is suitable for induction cooking.***PENTOLA 2 MANICI**

Pot, 2-handle

Antiaderente / Non-stick

	Ø Cm	H Cm	lt
V68 11 72 PE 28	28	15	9

CASSERUOLA 1 MANICO

Casserole, 1-handle

Antiaderente / Non-stick

	Ø Cm	H Cm	lt
V68 11 72 2CA 14	14	7	1
V68 11 72 2CA 16	16	8	1,6
V68 11 72 2CA 18	18	8,8	2,2
V68 11 72 2CA 20	20	8,8	2,8

**CASSERUOLA 2 MANICI**

Casserole, 2-handle

ANTIADERENTE / NON-STICK

	Ø Cm	H Cm	lt
V68 11 72 CA 20A	20	8,8	2,8
V68 11 72 CA 22	22	9,2	3,5
V68 11 72 CA 24	24	10,7	4,8
V68 11 72 CA 26	26	11,8	6,2
V68 11 72 CA 28	28	12	7,4
V68 11 72 CA 32	32	12	9,5

**TEGAME 2 MANICI**

Saucepan, 2-handle

Antiaderente / Non-stick

	Ø Cm	H Cm
V68 11 72 TE 24	24	6
V68 11 72 TE 28	28	7
V68 11 72 TE 32	32	7,5
V68 11 72 TE 36	36	8
V68 11 72 TE 40	40	8,5



PADELLA 1 MANICO

Frying pan, 1-handle

Alluminio / Aluminum

	Ø Cm	H Cm
V67 11 72 PA 24	24	6
V67 11 72 PA 28	28	7
V67 11 72 PA 32	32	7,5
V67 11 72 PA 36	36	8
V67 11 72 PA 40	40	8,5

PENTOLA 2 MANICI

Pot, 2-handle

Alluminio / Aluminum

	Ø Cm	H Cm	lt
V67 11 72 PE 28	28	15	9

CASSERUOLA 2 MANICI

Casserole, 2-handle

Alluminio / Aluminum

	Ø Cm	H Cm	lt
V67 11 72 CA 32	32	11,5	9,5

TEGAME 2 MANICI

Saucepan, 2-handle

Alluminio / Aluminum

	Ø Cm	H
V67 11 72 TE 24	24	6
V67 11 72 TE 28	28	7
V67 11 72 TE 32	32	7,5
V67 11 72 TE 36	36	8
V67 11 72 TE 40	40	8,5

**MANICO IN ACCIAIO INOX**
stainless steel handle**ALLUMINIO**
aluminum**CUCINART**

Esterno ed interno in alluminio e manici in acciaio inox.

Il fondo è idoneo per la cottura ad **induzione**.**CUCINART LINE**

Aluminum inside and outside with stainless steel handles.

The bottom is suitable for **induction** cooking.**COOK & SERVE**

Il nuovo tegame Cook & Serve è una soluzione comoda e pratica. Ideale per la cottura degli alimenti grazie al fondo di 2mm e alla conducibilità dell'alluminio, che permette una diffusione uniforme del calore sull'intera superficie. Leggero, maneggevole ed elegante, diventa un accessorio perfetto anche per il servizio in tavola.

COOK & SERVE

The new pan Cook & Serve is a convenient and practical solution. Ideal for cooking food, thanks to its 2-mm bottom and to aluminum conductivity, that allows a uniform heat diffusion on the whole surface.

Light, easy to handle and elegant, it becomes the perfect tool for the table service as well.

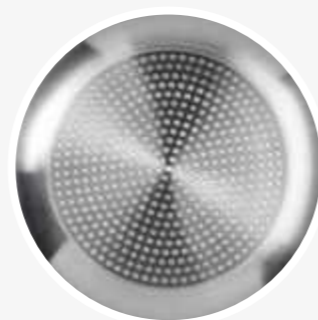
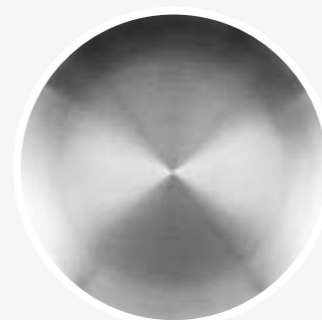
**IDONEO PER TUTTI I PIANI DI COTTURA**
compatible with all cooktops**TEGAME 2 MANICI**

Saucepan, 2-handle

Alluminio / Aluminum

	Ø Cm	H Cm
V67 11 72 TP 16	16	4,5
V67 11 72 TP 18	18	4,5
V67 11 72 TP 20	20	4,5
V67 11 72 TP 22	22	4,5
V67 11 72 TP 24	24	4,5



MANNARETTA
Cleaver

Acciaio inossidabile / St. Steel

V67 06 91 027	Cm 18
---------------	----------

**COLTELLO CHEF**
Chef knife

Acciaio inossidabile / St. Steel

V67 06 91 001	Cm 15
V67 06 91 002	20
V67 06 91 025	23
V67 06 91 026	25

**COLTELLO AFFETTARE**
Slice knife

Acciaio inossidabile / St. Steel

V67 06 91 004	Cm 20
---------------	----------

**COLTELLO SANTOKU**
Santoku knife

Acciaio inossidabile / St. Steel

V67 06 91 006	Cm 18
V67 06 91 005	12,5

**COLTELLO UTILITY**
Utility knife

Acciaio inossidabile / St. Steel

V67 06 91 009	Cm 14
---------------	----------

**COLTELLO PANE**
Bread knife

Acciaio inossidabile / St. Steel

V67 06 91 003	Cm 20
---------------	----------

**COLTELLO SPELUCCHINO**
Paring knife

Acciaio inossidabile / St. Steel

V67 06 91 010	Cm 8,8
---------------	-----------

**COLTELLO DISSOSSARE**
Boning knife

Acciaio inossidabile / St. Steel

V67 06 91 007	Cm 16
---------------	----------

**MANICO RIVETTATO**
riveted handle**ACCIAIO INOSSIDABILE**
st. steel**CUCINART LINE**

coltelli professionali Cucinart forgiati in **acciaio inossidabile** con manico in POM lucido rivettato.

Design accurato, prestazioni eccellenti. Perché solo gli strumenti giusti possono rendere il lavoro impeccabile, soprattutto in cucina.

CUCINART LINE

*Cucinart professional knives, forged, **stainless steel** with POM mirror riveted handle. Careful design, excellent performance. Because only the right tools can make the impeccable work, especially in the kitchen.*

**COLTELLO PROFESSIONALE UTILITY**
Professional utility knife

Acciaio inossidabile / St. Steel

V67 06 91 008	Cm 11,5
---------------	------------

**COLTELLO PROFESSIONALE FRUTTA**
Professional fruit knife

Acciaio inossidabile / St. Steel

V67 06 91 011	Cm 8,8
---------------	-----------

**AFFILACOLTELLI PROFESSIONALE**
Professional sharpener

Acciaio inossidabile / St. Steel

V67 06 91 012	Cm 20
---------------	----------

**SET COLTELLI CUCINART 3PZ MANICO AVORIO**
3-pc knife set Cucinart white handle

Acciaio inossidabile / St. Steel

V67 06 91 S03	Cm
composizione/composition	
1 coltello chef/1 chef knife	20
1 coltello pane/1 bread knife	20
1 coltello spelucchino/1 paring knife	11



IN SCATOLA VETRINA/IN WINDOW BOX

SET COLTELLI CUCINART 5PZ MANICO AVORIO
5-pc knife set Cucinart white handle

Acciaio inossidabile / St. Steel

V67 06 91 S04	Cm
composizione/composition	
1 coltello chef/1 chef knife	20
1 coltello pane/1 bread knife	20
1 coltello affettare/1 slice knife	20
1 coltello cucina/1 cook's knife	16
1 coltello spelucchino/1 paring knife	11



IN SCATOLA VETRINA/IN WINDOW BOX

MESTOLO

Ladle

Nylon PA 6,6 FG 10%

	Cm
■ 903 12 81 C15 ME	32
■ 903 12 81 C47 ME	32

**SCHIUMAROLA**

Skimmer

Nylon PA 6,6 FG 10%

	Cm
■ 903 12 81 C15 SC	35
■ 903 12 81 C47 SC	35

**PALETTA FRITTO**

Frying shovel

Nylon PA 6,6 FG 10%

	Cm
■ 903 12 81 C15 FR	35
■ 903 12 81 C47 FR	35

**PALETTA**

Shovel

Nylon PA 6,6 FG 10%

	Cm
■ 903 12 81 C15 PA1	35
■ 903 12 81 C47 PA1	35

**CUCCHIAIONE FORATO**

Slotted spoon

Nylon PA 6,6 FG 10%

	Cm
■ 903 12 81 C15 CUF	35
■ 903 12 81 C47 CUF	35

**CUCCHIAIONE**

Serving spoon

Nylon PA 6,6 FG 10%

	Cm
■ 903 12 81 C15 CU	35
■ 903 12 81 C47 CU	35

**PALETTA**

Shovel

Nylon PA 6,6 FG 10%

	Cm
■ 903 12 81 C15 PA2	32
■ 903 12 81 C47 PA2	32

**SERVISPAGHETTI**

Spaghetti serving spoon

Nylon PA 6,6 FG 10%

	Cm
■ 903 12 81 C15 SP	33,5
■ 903 12 81 C47 SP	33,5

**PALETTA FORATA**

Slotted shovel

Nylon PA 6,6 FG 10%

	Cm
■ 903 12 81 C15 PAF	31,5
■ 903 12 81 C47 PAF	31,5

**PINZA CHEF**

Chef tongs

Nylon PA 6,6 FG 10%

	Cm
■ 903 12 81 C15 PI	30,5
■ 903 12 81 C47 PI	30,5

**MOLLA TOAST/DOLCE**

Dessert/toast tongs

Nylon PA 6,6 FG 10%

	Cm
■ 903 12 81 C15 MD	28
■ 903 12 81 C47 MD	28

**MOLLA SPAGHETTI**

Spaghetti tongs

Nylon PA 6,6 FG 10%

	Cm
■ 903 12 81 C15 MS	31
■ 903 12 81 C47 MS	31

**PALETTA FRITTO**

Frying shovel

Nylon PA 6,6 FG 10%

	Cm
■ 903 12 81 C15 PAA	32
■ 903 12 81 C47 PAA	32

**PALETTA SCOLATUTTO**

Multi-purpose strainer

Nylon PA 6,6 FG 10%

	Cm	L Cm
■ 903 12 81 C15 PFG	38	11,5
■ 903 12 81 C47 PFG	38	11,5

**MOLLA INSALATA**

Salad tongs

Nylon PA 6,6 FG 10%

	Cm
■ 903 12 81 C15 MI	31
■ 903 12 81 C47 MI	31

**MOLLA ARROSTO**

Roast tongs

Nylon PA 6,6 FG 10%

	Cm
■ 903 12 81 C15 MA	31
■ 903 12 81 C47 MA	31



A TAVOLA

BROCCA
Pitcher

PORTA TORTA
Cake Carrier





PORTA FORMAGGIO

Cheese dish

PP

	Ø Cm	H Cm
■ V60 12 94 011 47	30	12,5
□ V60 12 94 011 13	30	12,5
■ V60 12 94 011 38	30	12,5

EUTETTICI NON INCLUSI / COOLING PACKS NOT INCLUDED



SET 2PZ EUTETTICI

Cooling tray, 2-pc

	Cm	H Cm
V77 12 95 P02	12,5x5,5	1,5

ACQUISTARE SEPARATAMENTE / BUY SEPARATELY



MANIGLIA
Handle

Può essere utilizzato in microonde, lavastoviglie, freezer. *Microwave, dishwasher, freezer safe.*



VANO PORTA EUTETTICI
Ice-pack compartment

PORTA FORMAGGIO grazie alle tavolette refrigeranti* poste sul fondo del vassoio, gli **alimenti** rimangono **freschi** più a lungo. Il portaformaggi è l'ideale **per conservare e servire** formaggi e non solo.

* NON INCLUSE NEL PORTAFORMAGGIO
* ACQUISTABILI SEPARATAMENTE

CHEESE DISH

thanks to the cooling packs placed on the bottom of the tray, food keeps **fresh longer**. The cheese dish is the ideal **to store and serve** cheese and not only.*

* NOT INCLUDED IN THE CHEESE DISH
* BUY SEPARATELY

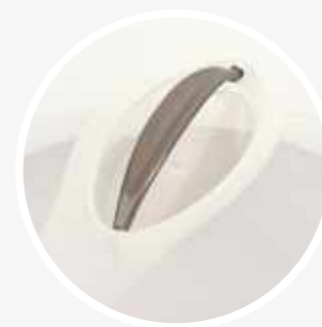

MANIGLIA
Handle

Può essere utilizzato in microonde, lavastoviglie, freezer. *Microwave, dishwasher, freezer safe.*



GANCIO CHIUSURA
Closing hook

PORTA TORTA

grazie alle tavolette refrigeranti* poste sul fondo del vassoio, gli **alimenti** rimangono **freschi** più a lungo. Il portatore è l'ideale per **trasportare e servire** torte e dolci, tartine, frutta, ecc, grazie alla pratica maniglia sul coperchio.

* NON INCLUSE NEL PORTATORTA
* ACQUISTABILI SEPARATAMENTE

CAKE CARRIER

*thanks to the cooling packs placed on the bottom of the tray, food keeps **fresh longer**.*

*The cake carrier is the ideal to **carry and serve** cakes and sweets, sandwiches, fruit, etc., thanks to the practical handle on the cover.*

* NOT INCLUDED IN THE CHEESE DISH
* BUY SEPARATELY



PORTATORTA

Cake carrier

PP

	Ø Cm
■ V60 12 94 010 47	30
□ V60 12 94 010 13	30
■ V60 12 94 010 38	30

EUTETTICI NON INCLUSI / COOLING PACKS NOT INCLUDED



SET 2PZ EUTETTICI

Cooling tray, 2-pc

	Cm	H Cm
V77 12 95 P02	12,5x5,5	1,5

ACQUISTARE SEPARATAMENTE / BUY SEPARATELY



BROCCA

Pitcher

Acrilico / Acrylic

	Lt	color
<input type="checkbox"/> V60 12 08 001 13	2	white
<input checked="" type="checkbox"/> V60 12 08 001 00	2	transparent

**BROCCA DIAMOND**

Pitcher

Acrilico / Acrylic

	Lt	color
<input checked="" type="checkbox"/> V60 12 08 003 00	2,5	transparent

**BROCCA ELEGANT**

Pitcher

Acrilico / Acrylic

	Lt	color
<input checked="" type="checkbox"/> V60 12 08 004 00	2	transparent

**CARAFFA**

Pitcher

Acrilico con tappo PP / Acrylic with PP lid

	Lt	color
<input type="checkbox"/> V60 12 08 002 13	1,5	white
<input checked="" type="checkbox"/> V60 12 08 002 47	1,5	dove grey

**SECCHIO SPUMANTE**

Champagne bucket 1 bottle

	Cm	Materiale/material
<input checked="" type="checkbox"/> V81 12 20 001	22x16x23,5	acrilico/acrylic
<input checked="" type="checkbox"/> V81 12 20 004	22x16x23,5	PS transparent
<input type="checkbox"/> V81 12 20 007	22x16x23,5	PS white

**SECCHIO MAGNUM**

Magnum champagne bucket

	Cm	Materiale/material
<input checked="" type="checkbox"/> V81 12 20 002	27,9x17,3x23,4	acrilico/acrylic
<input checked="" type="checkbox"/> V81 12 20 005	27,9x17,3x23,4	PS transparent
<input type="checkbox"/> V81 12 20 008	27,9x17,3x23,4	PS white

**SECCHIO JEROBOAM**

Jeroboam champagne bucket

	Cm	Materiale/material
<input checked="" type="checkbox"/> V81 12 20 003	48,2x20,9x24,3	acrilico/acrylic
<input checked="" type="checkbox"/> V81 12 20 006	48,2x20,9x24,3	PS transparent
<input type="checkbox"/> V81 12 20 009	48,2x20,9x24,3	PS white



CONTENITORE ERMETICO RETTANGOLARE 0,3 LT

Rectangular hermetic food container 0,3 lt

Salvafreschezza / Freshness saver

	Cm	H Cm	Lt
AVARITCO A01	11,3 x 7,5	5,7	0,3

**CONTENITORE ERMETICO RETTANGOLARE 0,6 LT**

Rectangular hermetic food container 0,6 lt

Salvafreschezza / Freshness saver

	Cm	H Cm	Lt
AVARITCO A02	11,3 x 7,5	11	0,6

**CONTENITORE ERMETICO RETTANGOLARE 1 LT**

Rectangular hermetic food container 1 lt

Salvafreschezza / Freshness saver

	Cm	H Cm	Lt
AVARITCO A03	22,4 x 15,2	5,2	1

**CONTENITORE ERMETICO RETTANGOLARE 1,5 LT**

Rectangular hermetic food container 1,5 lt

Salvafreschezza / Freshness saver

	Cm	H Cm	Lt
AVARITCO A04	22,4 x 15,2	7,2	1,5

**CONTENITORE ERMETICO RETTANGOLARE 2 LT**

Rectangular hermetic food container 2 lt

Salvafreschezza / Freshness saver

	Cm	H Cm	Lt
AVARITCO A05	22,4 x 15,2	9,6	2

**CONTENITORE ERMETICO RETTANGOLARE 2,6 LT**

Rectangular hermetic food container 2,6 lt

Salvafreschezza / Freshness saver

	Cm	H Cm	Lt
AVARITCO A06	22,4 x 15,2	11,5	2,6

**CONTENITORE ERMETICO RETTANGOLARE 4 LT**

Rectangular hermetic food container 4 lt

Salvafreschezza / Freshness saver

	Cm	H Cm	Lt
AVARITCO A08	30 x 22	9,5	4



SET 4 CONTENITORI ERMETICI COLORE AVIO

4-PC Hermetic food container set air force blue

Salvafreschezza / Freshness saver

909 12 000 30

SET COMPOSTO DA: / COMPOSITION:

N.1 CONTENITORE lt 0,3 / N.1 CONTAINER lt 0,3
 N.1 CONTENITORE lt 0,6 / N.1 CONTAINER lt 0,6
 N.1 CONTENITORE lt 1,5 / N.1 CONTAINER lt 1,5
 N.1 CONTENITORE lt 2 / N.1 CONTENITORE lt 2

IN SCATOLA LITO / IN LITHO BOX

Utilizzabili in frigorifero, freezer, forno microonde e lavastoviglie.
 Garantiscono la totale ermeticità all'aria e all'acqua.

*Suitable for refrigerator, freezer, micro-wave and dishwasher safe.
 They are air-tight and water-tight.*



UN COMPLETO SET
 A COMPLETE SET



APERTURA PER RIEMPIMENTO
 FILLING OPENING



DOSATORE IN DUE MISURE
 2-SIZE DISPENSER

Contenitori salvafreschezza caratterizzati da chiusura ermetica, per la perfetta conservazione di ogni alimento. Utilizzabili in frigorifero, freezer, forno a microonde e lavastoviglie, garantiscono la migliore protezione dall'aria e dall'acqua.

Freshness containers with hermetic closure for the perfect conservation of every type of food. Suitable for refrigerator, freezer, microwave oven and dishwasher, they guarantee the best protection from air and water.



DISTRIBUTORE MULTIUSO CEREALI PASTA RISO

Cereal, pasta, rice, multi-purpose dispenser

Contenitore in PP / body PP

	Cm	H Cm	Lt
■ AVARITCO 19 38	12,5x7	23,5	1,4
■ AVARITCO 19 40	12,5x7	23,5	1,4
■ AVARITCO 19 47	12,5x7	23,5	1,4



BARATTOLO MULTIUSO

Multi-purpose container

Contenitore in PS / body PS

	Cm	H Cm	Lt
■ V60 12 94 006 38	11x11	9	0,8
■ V60 12 94 006 40	11x11	9	0,8
□ V60 12 94 006 48	11x11	9	0,8
■ V60 12 94 006 47	11x11	9	0,8



BARATTOLO MULTIUSO

Multi-purpose container

Contenitore in PS / body PS

	Cm	H Cm	Lt
■ V60 12 94 007 38	11x11	12,5	1,1
■ V60 12 94 007 40	11x11	12,5	1,1
□ V60 12 94 007 48	11x11	12,5	1,1
■ V60 12 94 007 47	11x11	12,5	1,1



BARATTOLO MULTIUSO

Multi-purpose container

Contenitore in PS / body PS

	Cm	H Cm	Lt
■ V60 12 94 008 38	11x11	18	1,6
■ V60 12 94 008 40	11x11	18	1,6
□ V60 12 94 008 48	11x11	18	1,6
■ V60 12 94 008 47	11x11	18	1,6



BARATTOLO MULTIUSO

Multi-purpose container

Contenitore in PS / body PS

	Cm	H	Lt
■ V60 12 94 009 38	11x11	28	2,5
■ V60 12 94 009 40	11x11	28	2,5
□ V60 12 94 009 48	11x11	28	2,5
■ V60 12 94 009 47	11x11	28	2,5



TAPPO IN PP
PP lid



CHIUSURA ERMETICA
ermetic closure

COLOR STYLE

tappo in PP e gomma bicolore
con sistema di **chiusura
ermetico**.

COLOR STYLE

lid in PP and bicolor plastic
with **airtight**.



SCOLAPASTA

Colander

PP

	Ø Cm	H Cm
■ V60 12 94 001 38	29	12
■ V60 12 94 001 40	29	12
□ V60 12 94 001 48	29	12
■ V60 12 94 001 47	29	12



PORTAROTOLO

Paper holder

PP

	Cm	H Cm
■ V60 12 94 003 38	16,5x17,5	30
■ V60 12 94 003 40	16,5x17,5	30
□ V60 12 94 003 48	16,5x17,5	30
■ V60 12 94 003 47	16,5x17,5	30



SCOLAPOSATE

Cutlery drainer

PP

	Ø Cm	H Cm
■ V60 12 94 005 38	16	16,5
■ V60 12 94 005 40	16	16,5
□ V60 12 94 005 48	16	16,5
■ V60 12 94 005 47	16	16,5



PORTAPOSATE

Drawer cutlery holder

PP

	Cm	H Cm
■ V60 12 94 002 38	27x35	6,5
■ V60 12 94 002 40	27x35	6,5
□ V60 12 94 002 48	27x35	6,5
■ V60 12 94 002 47	27x35	6,5



PORTATOVAGLIOLI

Tissue holder

PP

	Cm	H Cm
■ V60 12 94 004 38	17x12,5	10
■ V60 12 94 004 40	17x12,5	10
□ V60 12 94 004 48	17x12,5	10
■ V60 12 94 004 47	17x12,5	10



BAR COLAZIONE

CESTINO PANE
Bread Basket

CARAFFA
Pitcher





SACCHETTO PORTAPANE

Bread basket

Cotone / Cotton

	Ø Cm	H Cm
■ AVARI 206	21	25
■ AVARI 207	21	25



CESTINO PANE

Bread basket

Cotone / Cotton

	Cm	H Cm
■ AVARI 161B	11x11	15
■ AVARI 163B	18x18	18



CESTINO PANE

Bread basket

Cotone / Cotton

	Cm	H Cm
■ AVARI 162B	11x11	15
■ AVARI 164B	18x18	18



CESTINO PANE BICOLORE

Bread basket

Cotone e poliesterre / Cotton and polyester

	Ø Cm	H Cm
■ AVARI 211	17	8
■ AVARI 212	20	9

CESTINI PANE IN COTONE
cuscino con noccioli di ciliegia, **riscaldabile**. I cestini sono confezionati in pratici cavallotti a blister su cui sono stampate tutte le informazioni, comprese quelle di utilizzo e lavaggio.

COTTON BREAD BASKET
pillow with cherry stones, heated.
The bread baskets come in practical hangable packs with all the information, including use and washable.



FASCIA APPENDIBILE
hanging card



MADE IN ITALY
made in Italy



CUSCINO CON NOCCIOLI

Cherry-stone cushion

Cotone / Cotton

	Cm
■ 325 05 24 579	11x11
■ 325 05 24 580	18x18



CESTINI PANE CON CUSCINO

Bread basket with pillow

Cotone / Cotton

	Cm	Pz
■ AVARI 151	11x11x15	1
■ AVARI 150	11x11x15	1
■ AVARI 153	18x18x18	1
■ AVARI 152	18x18x18	1



CESTINO PANE

Bread basket

Cotone / Cotton

	Cm	Pz
■ AVARI 162	11x11x15	1
■ AVARI 161	11x11x15	1
■ AVARI 164	18x18x18	1
■ AVARI 163	18x18x18	1



CESTINO PANE

Bread basket

Cotone / Cotton

	Cm	Pz
■ AVARI 154	11x11x15	3
■ AVARI 155	11x11x15	3
■ AVARI 156	18x18x18	2
■ AVARI 157	18x18x18	2





Adatti all'utilizzo con i cuscini vedi P.24
Suitable for use with pillows P.24



CESTINO PANE

Bread basket

Cotone / Cotton

	Cm	H Cm
■ AVARI 200	14x14	8
■ AVARI 203	19x19	10



CESTINO PANE

Bread basket

Cotone / Cotton

	Cm	H Cm
■ AVARI 201	14x14	8
■ AVARI 204	19x19	10



CESTINO PANE

Bread basket

Juta

	Cm	H Cm
■ AVARI 202	14x14	8
■ AVARI 205	19x19	10



CESTINO MIGNON PORTABUSTINE

Tea/Sugar-bag holder mignon

Cotone / Cotton

	Cm	H Cm	
■ AVARI 208	6x8	6	beige
■ AVARI 209	6x8	6	marrone
■ AVARI 210	6x8	6	juta

RUNNER GRIGIO SCURO

Runner, dark grey

70% Pvc - 30% Pet

	Cm
AVARI TO 31	45x120



RUNNER GRIGIO CHIARO

Runner, light grey

70% Pvc - 30% Pet

	Cm
AVARI TO 30	45x120



RUNNER GRIGIO TORTORA

Runner, taupe

70% Pvc - 30% Pet

	Cm
AVARI TO 32	45x120



RUNNER GRIGIO SABBIA

Runner, sand

70% Pvc - 30% Pet

	Cm
AVARI TO 33	45x120



RUNNER GRIGIO MARRONE C/ RETTANGOLO

Runner, brown with rectangle

70% Pvc - 30% Pet

	Cm
AVARI TO 34	45x120



TOVAGLIETTA MARRONE C RETTANGOLO
 Placemat, brown with rectangle

70% Pvc - 30% Pet

 AVARI TO 10
 Cm
 45x30

TOVAGLIETTA SABBIA/TORTORA A QUADRI
 Placemat, sand/taupe with squares

70% Pvc - 30% Pet

 AVARI TO 11
 Cm
 45x30

TOVAGLIETTA MARRONE A QUADRI
 Placemat, brown with squares

70% Pvc - 30% Pet

 AVARI TO 12
 Cm
 45x30

TOVAGLIETTA BIANCA 2 FASCE LATERALI
 Placemat, white with 2 side stripes

70% Pvc - 30% Pet

 AVARI TO 13
 Cm
 45x30

TOVAGLIETTA MARRONE 2 FASCE LATERALI
 Placemat, brown with 2 side stripes

70% Pvc - 30% Pet

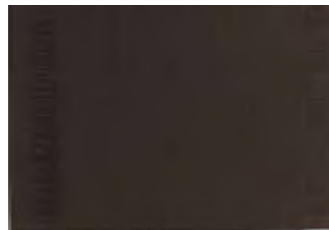
 AVARI TO 14
 Cm
 45x30

TOVAGLIETTA GRIGIO SCURO
 Placemat, dark grey

70% Pvc - 30% Pet

 AVARI TO 01
 Cm
 45x30

TOVAGLIETTA GRIGIO CHIARO
 Placemat, light grey

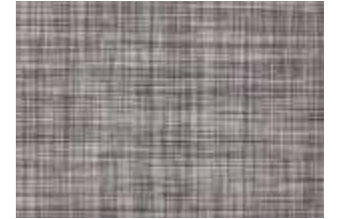
70% Pvc - 30% Pet

 AVARI TO 02
 Cm
 45x30

TOVAGLIETTA TORTORA
 Placemat, taupe

70% Pvc - 30% Pet

 AVARI TO 03
 Cm
 45x30

TOVAGLIETTA BEIGE/MARRONE/RIGA AZZURRA
 Placemat, beige/brown/blue stripe

70% Pvc - 30% Pet

 AVARI TO 05
 Cm
 45x30

TOVAGLIETTA SABBIA
 Placemat, sand

70% Pvc - 30% Pet

 AVARI TO 07
 Cm
 45x30

TOVAGLIETTA MARRONE LAVORATO
 Placemat, woven brown

70% Pvc - 30% Pet

 AVARI TO 08
 Cm
 45x30

TOVAGLIETTA BAMBOO MARRONE CHIARO

Placemat, bamboo light brown

Bamboo

AVARI TO 40
Cm
45x30**TOVAGLIETTA RIQUADRI**

Placemat, frames

70% Pvc - 30% Pet

AVARI TO 50
Cm
45x30**TOVAGLIETTA INTRECCIATA NERA**

Placemat, woven black

70% Pvc - 30% Pet

AVARI TO 61
Cm
45x30**TOVAGLIETTA INTRECCIATA BEIGE**

Placemat, woven sand

70% Pvc - 30% Pet

AVARI TO 63
Cm
45x30**TOVAGLIETTA BAMBOO MARRONE SCURO**

Placemat, bamboo dark brown

Bamboo

AVARI TO 41
Cm
45x30**TOVAGLIETTA INTRECCIATA GRIGIA**

Placemat, woven grey

70% Pvc - 30% Pet

AVARI TO 60
Cm
45x30**TOVAGLIETTA INTRECCIATA MARRONE**

Placemat, woven brown

70% Pvc - 30% Pet

AVARI TO 62
Cm
45x30**SET 4 TOVAGLIETTE GRIGIO CHIARO**

4-pc set placemat, light grey

70% Pvc - 30% Pet

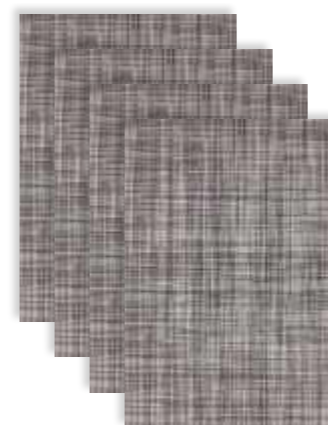
AVARI TO 02 S4
Cm
45x30**SET 4 TOVAGLIETTE TORTORA**

4-pc set placemat, taupe

70% Pvc - 30% Pet

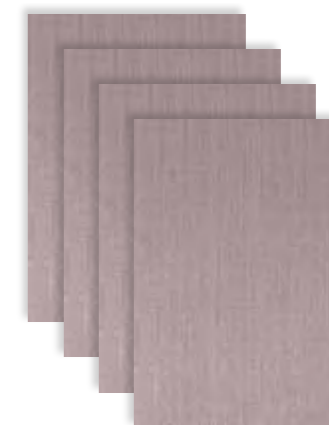
AVARI TO 03 S4
Cm
45x30**SET 4 TOVAGLIETTE SABBIA**

4-pc set placemat, sand

70% Pvc - 30% Pet

AVARI TO 07 S4
Cm
45x30**BOX 12 SET 4 PZ TOVAGLIETTE**

Box 12 set 4-pc set placemat

AVARI TO 9B 01



GRATTUGIA
Grater

TAGLIA PASTA
Pasta Cutter

PALA DOLCE
Cake Server

COLTELLO DAILY PLUS
Daily Plus Knife

CUCINA



Acciaio inossidabile e design essenziale per una gamma che si distingue per la varietà ed è in grado di rispondere ad ogni esigenza.

TAGLIA PASTA

Pasta cutter

Acciaio inossidabile / Stainless steel

V59 06 95 008 Cm
18,5

**TAGLIA PIZZA**

Pizza cutter

Acciaio inossidabile / Stainless steel

V59 06 95 009 Cm
19,5

**APRIBOTTIGLIE**

Bottle opener

Acciaio inossidabile / Stainless steel

V59 06 95 006 Cm
18,5

**COLINO**

Strainer

Acciaio inossidabile / Stainless steel

	Ø Cm	L Cm
V59 06 95 001	6,5	23
V59 06 95 002	9	24

**LEVATORSOLI**

Apple corer

Acciaio inossidabile / Stainless steel

V59 06 95 003 Cm
20

**SCAVINO**

Corer

Acciaio inossidabile / Stainless steel

V59 06 95 004 Cm
16,5

**PELA LIMONI**

Lemon peeler

Acciaio inossidabile / Stainless steel

V59 06 95 005 Cm
16

**PELA PATATE**

Potato peeler

Acciaio inossidabile / Stainless steel

V59 06 95 007 Cm
18,5



Stainless steel and simple design for a range that stands out for its assortment and capable of satisfying every need.

PORZIONATORE GELATO

Ice cream scoop

Acciaio inossidabile / Stainless steel

V59 06 95 010 Cm
19,5

**AFFETTA FORMAGGIO**

Cheese slicer

Acciaio inossidabile / Stainless steel

V59 06 95 011 Cm
21,5

**SPREMI AGLIO**

Garlic squeezer

Acciaio inossidabile / Stainless steel

Cm

V59 06 95 012 18,3

**APRILATTINE**

Can opener

Acciaio inossidabile / Stainless steel

Cm

V59 06 95 013 21,5

**APRIBARATTOLI**

Jar opener

Acciaio inossidabile / Stainless steel

V59 06 95 014 Cm
26

**GRATTUGIA**

Grater

Acciaio inossidabile / Stainless steel

V59 06 95 015 Cm
24,5

**FRUSTA**

Whisk

Acciaio inossidabile / Stainless steel

V59 06 95 016 Cm
30
V59 06 95 017 35

**APRISCATOLE A LEVA**

Lever/can opener

Acciaio inossidabile / Stainless steel

V59 06 95 018 Cm
17,5



TAGLIA PASTA DOPPIO

Double pasta cutter

Acciaio inossidabile / Stainless steel

	Cm
V59 06 95 019	18

**PALA DOLCE SERVIRE**

Cake server

Acciaio inossidabile / Stainless steel

	Cm
V59 06 95 021	27,8

**CUCCHIAIONE SERVIRE**

Serving spoon

Acciaio inossidabile / Stainless steel

	Cm
V59 06 81 0CU	33

**PALA DOLCE**

Cake server

Acciaio inossidabile / Stainless steel

	Cm
V59 06 95 020	26,5

**MESTOLO SERVIRE**

Serving ladle

Acciaio inossidabile / Stainless steel

	Cm
V59 06 81 0ME	33

**FORCHETTONE SERVIRE**

Serving fork

Acciaio inossidabile / Stainless steel

	Cm
V59 06 81 0FO	33

**PINZA CHEF**

Chef tongs

Acciaio inossidabile / Stainless steel

	Cm
V59 06 81 P25	25
V59 06 81 P30	30

**PALA FRITTO**

Frying shovel

Acciaio inossidabile / Stainless steel

	Cm
V59 06 81 OPF	33

**MESTOLINO SALSA**

Sauce ladle

Acciaio inossidabile / Stainless steel

	Cm
V59 06 81 OMS	23

**PINZA GASTRONOMICA CURVA**

Gourmet tongs curve

Acciaio inossidabile / Stainless steel

	Cm
V59 06 81 PC 22	22
V59 06 81 PC 26	30
V59 06 81 PC 30	30

**SCHIUMAROLA**

Skimmer

Acciaio inossidabile / Stainless steel

	Cm
V59 06 81 OSC	33

**SERVISPAGHETTI**

Spaghetti serving spoon

Acciaio inossidabile / Stainless steel

	Cm
V59 06 81 OSP	33





CESTELLO CUOCIVERDURA

Vegetable steamer basket

Acciaio inossidabile 18|CR / St. steel

	Ø max Cm	Ø min Cm
V59 06 72 CE23	23	14
V59 06 72 CE28	28	16,5



CESTINO CUOCI/SCOLA/FRITTURE

Cook/Drain/Fry basket

Acciaio inossidabile 18|10 / 18|10 St. steel

	Ø Cm
V59 05 72 CS18	18

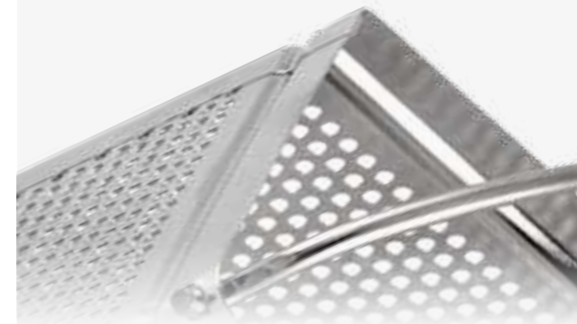

Cuoci e Scola è il nuovo set di cestini in acciaio inox 18/10 forato. Il triplo cestello, grazie alla comoda forma a spicchio, viene inserito nella pentola permettendo di cucinare contemporaneamente vari tipi di pasta o verdure con diversi tempi di cottura.

Cuoci e Scola is the new set of 18/10 stainless steel baskets with holes. The triple basket, thanks to its convenient orange-segment shape, is placed in the pan, allowing to cook various types of pasta, or vegetables with different cooking times, at the same time.

SERVISPAGHETTI

Spaghetti serving spoon

Acciaio inossidabile / Stainless steel

	Cm
V65 06 81 OSP	30



PALA FRITTO

Frying shovel

Acciaio inossidabile / Stainless steel

	Cm
V65 06 81 OPF	32



MESTOLO SERVIRE

Serving ladle

Acciaio inossidabile / Stainless steel

	Cm
V65 06 81 OME	30



CUCCHIAIONE SERVIRE

Serving spoon

Acciaio inossidabile / Stainless steel

	Cm
V65 06 81 OCU	32



FORCHETTONE SERVIRE

Serving fork

Acciaio inossidabile / Stainless steel

	Cm
V65 06 81 OFO	32



SCHIUMAROLA

Skimmer

Acciaio inossidabile / Stainless steel

	Cm
V65 06 81 OSC	32



BATTICARNE
Meat mallet

TPR + PP + ABS

	Cm
■ V60 12 950 15 38	22,5
■ V60 12 950 15 47	22,5

**PELALIMONI**
Lemon peeler

TPR + PP + ABS + AISI 430

	Cm
■ V60 12 950 08 38	19,5
■ V60 12 950 08 47	19,5

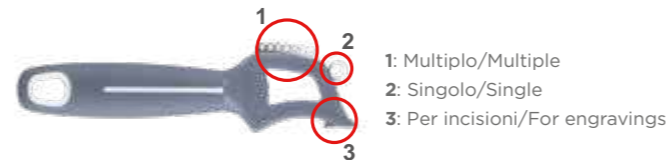
**PELAPATATE DOPPIA LAMA**
Potato peeler double blade

TPR + PP + ABS + AISI 420

	Cm
■ V60 12 950 10 38	17,5
■ V60 12 950 10 47	17,5

**PENNELLO IN SILICONE**
Silicone brush

TRP + PP + Nylon + Silicone

	Cm
■ V60 12 950 11 38	20
■ V60 12 950 11 47	20

**PORZIONATORE GELATO**
Ice cream scoop

TPR + PP + ABS

	Cm
■ V60 12 950 12 38	20
■ V60 12 950 12 47	20

**TAGLIAPIZZA**
Pizza cutter

TPR + PP + ABS + AISI 430

	Cm
■ V60 12 950 14 38	20,5
■ V60 12 950 14 47	20,5

**GRATTUGIA FORO GRANDE**
Grater big hole

TPR + PP + ABS + AISI 400

	Cm
■ V60 12 950 16 38	28,5
■ V60 12 950 16 47	28,5

**APRIBOTTIGLIE / LATTINE**
Bottle / can opener

TPR + PP + ABS + AISI 420

	Cm
■ V60 12 950 09 38	17,5
■ V60 12 950 09 47	17,5

**GRATTUGIA FORO PICCOLO**
Grater small hole

TPR + PP + ABS + AISI 400

	Cm
■ V60 12 950 17 38	28,5
■ V60 12 950 17 47	28,5

**LEVATORSOLI**
Apple corer

TPR + PP + ABS

	Cm
■ V60 12 950 13 38	22
■ V60 12 950 13 47	22





SERVISPAGHETTI

Spaghetti serving spoon

Acciaio Inox/Stainless Steel

90 30 591 GSP Cm
29,5



MESTOLO SERVIRE

Serving ladle

Acciaio Inox/Stainless Steel

90 30 591 GME Cm
30



FORCHETTONE

Serving fork

Acciaio Inox/Stainless Steel

90 30 591 GFO Cm
33



PALAFRITTO

Frying shovel

Acciaio Inox/Stainless Steel

90 30 591 GFR Cm
35



CUCCHIAIONE

Serving spoon

Acciaio Inox/Stainless Steel

90 30 591 GCU Cm
33



SCHIUMAROLA

Skimmer

Acciaio Inox/Stainless Steel

90 30 591 GSC Cm
33



Antiscivolo
Non-slip

CUCCHIAIONE

Serving spoon

Nylon

■ 903 12 81 X15 CU Cm
29



PALA HAMBURGER

Hamburger strainer

Nylon

■ 903 12 81 X15 HA Cm
28,5



SERVISPAGHETTI

Spaghetti serving spoon

Nylon

■ 903 12 81 X15 SP Cm
29



PALAFRITTO

Frying shovel

Nylon

■ 903 12 81 X15 FR Cm
30



MESTOLO

Ladle

Nylon

■ 903 12 81 X15 ME Cm
29



SCHIUMAROLA

Skimmer

Nylon

■ 903 12 81 X15 SC Cm
28,5





CUCCHIAIONE

Serving spoon

Nylon PA 6,6 FG 10%

	Cm
■ 903 12 81 Y15 CU	31,5
■ 903 12 81 Y47 CU	31,5
■ 903 12 81 Y38 CU	31,5
■ 903 12 81 Y40 CU	31,5



MESTOLO

Ladle

Nylon PA 6,6 FG 10%

	Cm
■ 903 12 81 Y15 ME	29
■ 903 12 81 Y47 ME	29
■ 903 12 81 Y38 ME	29
■ 903 12 81 Y40 ME	29



SCHIUMAROLA

Skimmer

Nylon PA 6,6 FG 10%

	Cm
■ 903 12 81 Y15 SC	31,5
■ 903 12 81 Y47 SC	31,5
■ 903 12 81 Y38 SC	31,5
■ 903 12 81 Y40 SC	31,5



PALA FRITTO

Frying shovel

Nylon PA 6,6 FG 10%

	Cm
■ 903 12 81 Y15 FR	31,5
■ 903 12 81 Y47 FR	31,5
■ 903 12 81 Y38 FR	31,5
■ 903 12 81 Y40 FR	31,5



PALETTA SCOLATUTTO

Multi-purpose shovel

Nylon PA 6,6 FG 10%

	Cm	L
■ 903 12 81 Y15 PFG	35	11,5
■ 903 12 81 Y47 PFG	35	11,5
■ 903 12 81 Y38 PFG	35	11,5
■ 903 12 81 Y40 PFG	35	11,5



SERVISPAGHETTI

Spaghetti server

Nylon PA 6,6 FG 10%

	Cm
■ 903 12 81 Y15 SP	30
■ 903 12 81 Y47 SP	30
■ 903 12 81 Y38 SP	30
■ 903 12 81 Y40 SP	30



SET 3 PEZZI MESTOLAME

3-pc kitchen tool set

Nylon PA 6,6 FG 10%

■ 903 12 81 Y03 15
■ 903 12 81 Y03 47
■ 903 12 81 Y03 38
■ 903 12 81 Y03 40

COMPOSIZIONE / COMPOSITION
1: CUCCHIAIONE / SERVING SPOON
2: PALA FRITTO / FRYING SHOVEL
3: SCHIUMAROLA / SKIMMER



SET 3 PEZZI MESTOLAME

3-pc kitchen tool set

Nylon PA 6,6 FG 10%

■ 903 12 81 Y04 15
■ 903 12 81 Y04 47
■ 903 12 81 Y04 38
■ 903 12 81 Y04 40

COMPOSIZIONE / COMPOSITION
1: MESTOLO / LADLE
2: SCOLATUTTO / STRAINER
3: SERVISPAGHETTI / SPAGHETTI SERVING SPOON



SET 5 PEZZI MESTOLAME

5-pc kitchen tool set

Nylon PA 6,6 FG 10%

■ 903 12 81 Y14 155
■ 903 12 81 Y14 475
■ 903 12 81 Y14 385
■ 903 12 81 Y14 405



COMPOSIZIONE / COMPOSITION
1: CUCCHIAIONE / SERVING SPOON
2: MESTOLO / LADLE
3: SCHIUMAROLA / SKIMMER
4: SERVISPAGHETTI / SPAGHETTI SERVING SPOON
5: PALA FRITTO / FRYING SHOVEL



CESTINO IN FILO DUPLEX

Wire basket Duplex

Ferro verniciato / Varnished iron

	Ø Cm	H Cm
■ AVARI 22 415	23	12
■ AVARI 22 438	23	12
■ AVARI 22 447	23	12
■ AVARI 22 440	23	12
■ AVARI 22 315	25,5	13
■ AVARI 22 338	25,5	13
■ AVARI 22 347	25,5	13
■ AVARI 22 340	25,5	13

CESTINO TONDO IN FILO

Wire storage basket

Ferro grigio / Grey iron

	Ø Cm	H Cm
906 18 001	32	14



CESTINO OVALE IN FILO

Wire storage basket

Ferro grigio / Grey iron

	Cm	H Cm
906 18 002	34x27	15,5



CESTINO IN FILO DIAMOND

Wire basket Diamond

Ferro verniciato / Varnished iron

	Ø Cm	H Cm
■ AVARI 22 038	18	8
■ AVARI 22 040	18	8
■ AVARI 22 047	18	8
■ AVARI 22 138	23	10
■ AVARI 22 140	23	10
■ AVARI 22 238	28	11
■ AVARI 22 240	28	11
■ AVARI 22 247	28	11

CIOTOLA

Bowl

Acciaio inossidabile/Stainless steel

	Ø Cm
V59 06 43 013	13
V59 06 43 015	15
V59 06 43 020	20
V59 06 43 023	23,5
V59 06 43 026	26

**SET 3 PZ CIOTOLE**

Bowls, 3-pc set

Acciaio inossidabile/Stainless steel

	Ø Cm
V59 06 43 002	15
	20
	23,5

**CAFFETTIERA**

Coffee pot

Acciaio inossidabile - St. Steel

	tazze/cup	cl
906 05 044	2	15
906 05 045	4	30
906 05 045X	5	45
906 05 046	6	65
906 05 047	9	110

**LATTIERA**

Milk pot

Acciaio inossidabile - St. Steel

	tazze/cup	cl
906 05 048	2	15
906 05 049	4	30
906 05 049X	5	45
906 05 050	6	65
906 05 051	9	110

**ZUCCHERIERA**

Sugar bowl

Acciaio inossidabile - St. Steel

	gr
906 05 064	200

**TISANIERA**

Infusion maker

Pyrex + inox 18|10 + PP

	cl
AVARI 100	35
AVARI 101	60
AVARI 102	80



ACCESSORI

OLIERONA
Oil Server



MACINAPEPE
Pepper Grinder



INSALATIERA
Salad Bowl



SPREMIAGRUMI
Lemon Squeezer





TRIS INSALATIÈRE

Salad bowls, 3-pc

PP

	Ø Cm
■ ■ ■ 903 12 43 001	20 - 23 - 26
■ ■ ■ 903 12 43 006	20 - 23 - 26
■ ■ ■ 903 12 43 003	20 - 23 - 26



INSALATIÈRA 26 CM

26 cm salad bowl

PP

	Ø Cm	H Cm
□ Z77 19 43 013	26	10
■ Z77 19 43 047	26	10
■ Z77 19 43 038	26	10
■ Z77 19 43 040	26	10



INSALATIÈRA 23 CM

23 cm salad bowl

PP

	Ø Cm	H Cm
□ Z77 19 43 313	23	10
■ Z77 19 43 347	23	10
■ Z77 19 43 338	23	10
■ Z77 19 43 340	23	10



INSALATIÈRA 20 CM

20 cm salad bowl

PP

	Ø Cm	H Cm
□ Z77 19 43 213	20	8,5
■ Z77 19 43 247	20	8,5
■ Z77 19 43 238	20	8,5
■ Z77 19 43 240	20	8,5



COPPETTA QUADRA

Square bowl

PP

	Cm
■ AVARI TCO 1415	10 X 10
□ AVARI TCO 1413	10 x 10

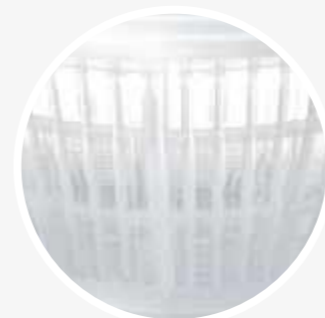
POMOLO ERGONOMICO
ergonomic knobCONTENITORE INTERNO
container inside

CENTRIFUGA INSALATA

perfetta per pulire al meglio ogni insalata, la centrifuga Easy Fresh è facile da utilizzare grazie al **pomolo ergonomico** sul coperchio. All'interno è presente un contenitore adatto al **servizio in tavola**.

SALAD SPINNER DRYER
*perfect for the best cleaning of salad, Easy Fresh salad spinner dryer is easy to use thanks to the **ergonomic knob** on the cover. Inside there is a container suitable for the **table serving**.*



SET 2 PZ INSALATA

La particolarità del manico la rende una pratica molla insalata.

2-PC SALAD SET

The special handle makes it practical salad tongs.



CENTRIFUGA INSALATA

Salad spinner

PP

	Ø Cm
AVARI TCI 01	24



CENTRIFUGA INSALATA

Salad spinner

PP

	Ø Cm	colore pieno
■ AVARI TCI 01 47P	24	tortora / taupe
■ AVARI TCI 01 38P	24	avio / avion blue
■ AVARI TCI 01 40P	24	corallo / coral



SET 2 PEZZI INSALATA

2-pc salad set

PP

	Cm
■ V60 12 95 S02 47	31



SET MESTOLAME

Kitchen tools set

Nylon

	Pz	Cm
903 12 81 C05	5	33
903 12 81 C04	4	33



BOTTIGLIA CON FILTRO THE/TISANA

Tea/infusion bottle with filter

Acciaio inox 18|10 / 18|10 St. steel

■ ■ ■ AVARI 511 H Cm
23

BOX CON 12 PEZZI, COLORI ASSORTITI
12 PCS BOX, ASSORTED COLOURS

BOTTIGLIA RIPIEGABILE

Foldable bottle

Silicone

■ ■ ■ AVARI 510 (BOX 12) H Cm
13,5 - 23,5

BOX CON 12 PEZZI, COLORI ASSORTITI
12 PCS BOX, ASSORTED COLOURS



BOTTIGLIA THERMOS

Questa bottiglia è dotata di un tappo in acciaio inox 18/10 con filtro che impedisce la fuoriuscita di liquidi. Puoi riporre la borraccia in borsa o nella tasca laterale dello zaino, la temperatura della tua bevanda rimarrà invariata per ore.

THERMOS BOTTLE

This bottle is provided with a 18/10 stainless steel cap with filter, in order to avoid spilling liquids. You can put the bottle in your bag or in the side pocket of your backbag; the temperature of your beverage will not change for hours.



FILTRO
filter

BOTTIGLIA RIPIEGABILE

Ideale per escursioni in montagna, campeggio e viaggi, questa bottiglia sportiva in silicone si piega per adattarsi al tuo stile di vita, facendo risparmiare fino alla metà dello spazio. Il gancio consente inoltre di appenderla a qualsiasi zaino, bicicletta o cintura.

FOLDABLE BOTTLE

Ideal for a day trip to the mountains, camping and travels, this silicone sports bottle is foldable to suit your lifestyle, allowing you to save until half space. Also, it can be hanged by the hook to any backbag, bicycle or belt.

TIERRA

La bottiglia di cui non potrai più fare a meno! La linea Tierra in acciaio inox 18/10 è la bottiglia tascabile e riutilizzabile. Interamente eco-friendly, unisce design e colori per un risultato ottimale.

TIERRA

The bottle you will not be able to do without!

The 18/10 stainless steel linea Tierra is the pocket-sized, reusable bottle. Completely eco-friendly, it combines design and colours for the best result.

BOTTIGLIA ACCIAIO INOX 18/10

18|10 St. Steel Bottle

Acciaio inox 18|10 / 18|10 St. Steel

■ ■ ■ AVARI 513 H Cm
22

BOX CON 12 PEZZI, COLORI ASSORTITI
12 PCS BOX, ASSORTED COLOURS



BOTTIGLIA ACCIAIO DOPPIO CORPO

Double wall 18|10 St. Steel Bottle

Acciaio inox 18|10 / 18|10 St. Steel

■ ■ ■ AVARI 512 H Cm
26,5

BOX CON 12 PEZZI, COLORI ASSORTITI
12 PCS BOX, ASSORTED COLOURS



OLIERA 4 PZ JOLLY

Jolly 4-pc oil-vinegar cruet

PP + Vetro / PP + Glass

	H Cm
■ V10 12 11 004 47	21
■ V10 12 11 004 38	21
■ V10 12 11 004 40	21

**FORMAGGIERA JOLLY**

Jolly cheese grater

PP + PS

	Ø Cm
■ V10 12 13 001 47	8,5
■ V10 12 13 001 38	8,5
■ V10 12 13 001 40	8,5

**OLIERONA**

Oil server

Acciaio inox / St. Steel

	Lt
AVARI 071	0,5
AVARI 072	1,0

**OLIERONA CON TAPPO VERSATORE SALVAGOCCIA**

Oil server with drop stop pourer

Acciaio inox 18|10 / St. Steel

	Lt
AVARI 400	0,25
AVARI 401	0,5
AVARI 402	0,75
AVARI 403	1



TAPPO VERSATORE
SALVAGOCCIA IN SILICONE
silicone drop-stop pourer

MACINAPEPE / SPARGISALE

Pepper grinder / salt spreader

Acrilico + Ceramica + Al / Acrylic + Ceramic + Aluminum

	Ø Cm	H Cm	
AVARI 073	5	16	macinapepe/pepper grinder
AVARI 074	5	16	spargisale/salt spreader
AVARI 075	6	20,5	macinapepe/pepper grinder

**MACINAPEPE / SPARGISALE**

Pepper grinder / salt spreader

Acrilico + Ceramica + Al / Acrylic + Ceramic + Aluminum

	Cm	H Cm
AVARI 075 A	4x4	12
AVARI 075 B	4x4	9

**GRATTUGIA 4 FACCE**

Grater, 4-side

Acciaio inox + ABS / St. Steel + ABS

	Cm	H Cm
■ AVARI 175 34	8,5x6,4	14,8
□ AVARI 175 13	8,5x6,4	14,8
■ AVARI 175 47	8,5x6,4	14,8
■ AVARI 176 34	9X6,6	21,6
□ AVARI 176 13	9X6,6	21,6
■ AVARI 176 47	9X6,6	21,6
■ AVARI 063	9X6	20,5



SET 4 PZ FORBICI

Scissors, 4-pc set

Acciaio Inox + PS / St. Steel + PS

	Cm
■ ■ ■ ■ AVARI 187	21/15/13/12

**FORBICI MULTILAMA (5 LAME)**

Multiblade scissors (5-blade)

Acciaio Inox + PP Soft-touch / St. Steel + PP soft-touch

	Cm
■ AVARI 188 47	22

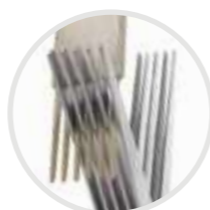
5 LAME
5-blade**FORBICI MULTIUSO CON CALAMITA**

Multi-purpose scissors with magnet

Acciaio inox + PP soft-touch / St. Steel + PP soft-touch

	Cm
■ AVARI 189 47	21

SCHIACCIANOCI
nutcracker**TRINCIAPOLLO**

Poultry shears

Acciaio inox + PP soft-touch / St. Steel + PP soft-touch

	Cm
■ AVARI 190 47	23

GANCIO DI SICUREZZA
safety hook**SPREMIAGRUMI**

Lemon squeezer

Contenitore in PS + tappo in PC / PS container + PC lid

	Ø Cm	H Cm
■ V60 12 95 006 47	12	10

**SET 3 IMBUTI**

3pc funnel set

PP

	Ø Cm	L Cm
■ AVARI 410 38	9/11/13	11,5/13,5/16
■ AVARI 410 40	9/11/13	11,5/13,5/16
■ AVARI 410 47	9/11/13	11,5/13,5/16

**TAGLIA MELA**

Apple corer

ABS + Acciaio inox / ABS + St. Steel

	Cm
■ AVARI 033 47	17,5
□ AVARI 033 13	17,5
□ AVARI 033 33	17,5

**LEVATAPPI A LEVA**

Lever corkscrew

PP + metallo / PP + metal

■ AVARI 186 47
■ AVARI 186 34
■ AVARI 185





CASSERUOLA COOKING STONE
Cooking Stone Casserole



**COTTURE
ANTIADERENTI**



PENTOLA NEW DREAM
New Dream Frying Pan



CASSERUOLA NEW DREAM
New Dream Casserole



PADELLA FORGIATA

Frying pan forged

Alluminio forgiato/Forged aluminum

	Ø Cm	H Cm
V85S 11 72 PA 20	20	4,5
V85S 11 72 PA 24	24	5
V85S 11 72 PA 28	28	5,5
V85S 11 72 PA 32	32	7,5



WOK FORGIATA

Wok forged

Alluminio forgiato/Forged aluminum

	Ø Cm	H Cm
V85S 11 72 WO 28	28	7,5



LINEA MOONDUST

Con la linea Moondust è possibile cucinare senza grassi aggiunti preparando piatti sani e saporiti. La straordinaria antiaderenza assicura una cottura perfetta e salutare senza oli né grassi. Moondust si caratterizza anche per un'altissima resistenza al calore e all'acqua salata, qualità che rendono la padella estremamente durevole nel tempo. Moondust di Abert, per una cucina sana e bilanciata, capace di esaltare i sapori naturali dei cibi.

LAVABILE IN LAVASTOVIGLIE

MOONDUST LINE

With the cookware line Moondust you can cook without added fat and prepare healthy and flavoursome dishes. The extraordinary non-stick performance of the coating ensures a perfect and healthy cooking, with no oil nor fat. Moondust also features a very high resistance to heat and salty water, qualities that make the pan remarkably long-lasting. Moondust by Abert, for a healthy and balanced cooking, able to enhance the natural taste of food.

DISHWASHER SAFE

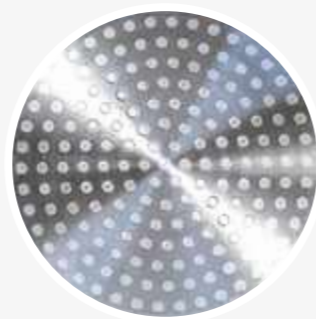

IDONEO PER TUTTI I PIANI DI COTTURA
compatible with all cooktops



CORPO ALLUMINIO FORGIATO
forged aluminum body



MANICO SOFT TOUCH
soft-touch handle



TEGAME FORGIATO

2-handles saucepan forged

Alluminio forgiato/Forged aluminum

	Ø Cm	H Cm
V85S 11 72 TE 26	26	7,6



CASSERUOLA 2 MANICI FORGIATA

2-handles casserole forged

Alluminio forgiato/Forged aluminum

	Ø Cm	H Cm	Lt
V85S 11 72 CA 20	20	8,5	1,2
V85S 11 72 CA 24	24	10,5	4,5



CASSERUOLA 1 MANICO FORGIATA

1-handle casserole forged

Alluminio forgiato/Forged aluminum

	Ø Cm	H Cm	Lt
V85S 11 72 CA 16	16	7	2,4



PADELLA EARTH FORGED
Frying pan Earth forged

Forgiato/Forged

	Ø Cm	H Cm
V41 11 72 PA 20	20	4,2
V41 11 72 PA 22	22	4,2
V41 11 72 PA 24	24	4,7
V41 11 72 PA 26	26	4,7
V41 11 72 PA 28	28	4,2
V41 11 72 PA 30	30	5,3
V41 11 72 PA 32	32	5,7

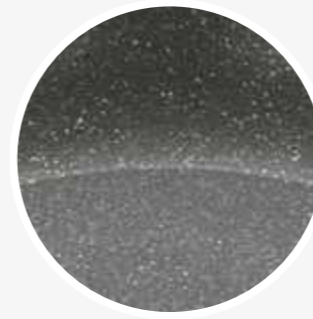

**INTERNO ANTIADERENTE
EFFETTO PIETRA**
non-stick stone-effect inside

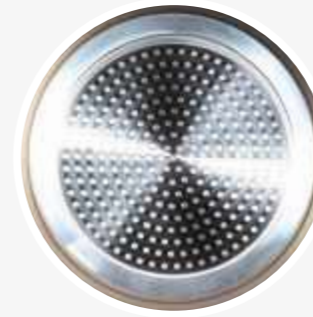

IDONEO PER TUTTI I PIANI DI COTTURA
compatible with all cooktops

LINEA EARTH

Forgiata in alluminio spessore mm 3,5 fondo induzione, interno antiaderente **effetto pietra**, esterno colore bronzo con manico soft touch bronzo.

LAVABILE IN LAVASTOVIGLIE

EARTH LINE

Aluminum Forged 3,5 mm thickness, induction bottom, non-stick **stone effect** inside, bronze outside, with soft touch bronze handle.

DISHWASHER SAFE



WOK FORGIATA
Wok forged

Forgiato/Forged

	Ø Cm	H Cm
V41 11 72 WO 28	28	7,5

PADELLA 1 MANICO
Frying pan, 1-handle

Alluminio pressofuso/Die-cast aluminum

	Ø Cm	H Cm
V83 11 72 PA 20	20	5
V83 11 72 PA 24	24	5,5
V83 11 72 PA 28	28	6
V83 11 72 PA 30	30	6,5



CASSERUOLA 1 MANICO
Casserole, 1-handle

Alluminio pressofuso/Die-cast aluminum

	Ø Cm	H Cm	lt
V83 11 72 CA 16	16	8,5	2



CASSERUOLA 2 MANICI
Casserole, 2-handle

Alluminio pressofuso/Die-cast aluminum

	Ø Cm	H Cm	lt
V83 11 72 CA 20	20	9,5	3
V83 11 72 CA 24	24	11,5	4



MANICO SOFT TOUCH
soft-touch handle

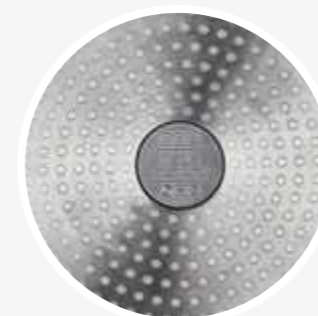

IDONEO PER TUTTI I PIANI DI COTTURA
compatible with all cooktops

NEW DREAM

in alluminio **pressofuso**, fondo ad **induzione**, manici soft touch, interno antiaderente, esterno colore grigio, bordo 6/9mm, fondo 4,5/5 mm

NEW DREAM

die-cast aluminum, induction bottom, soft-touch handle, non-stick grey outside, 6/9 mm edge, 4,5/5 mm bottom.



TEGAME ALTO 2 MANICI
Saucepan, 2-handle

Alluminio pressofuso/Die-cast aluminum

	Ø Cm	H Cm
V83 11 72 TE 28	28	8



TEGAME ALTO 1 MANICO, 1 MANIGLIA
Saucepan, 1-handle

Alluminio pressofuso/Die-cast aluminum

	Ø Cm	H Cm
V83 11 72 TM 8	28	8

**PADELLA**

Frying pan, 1-handle

Alluminio forgiato / Forged aluminum

	Ø Cm	H Cm
V46 11 72 PA 20	20	4,5
V46 11 72 PA 22	22	4,5
V46 11 72 PA 24	24	4,5
V46 11 72 PA 26	26	5
V46 11 72 PA 28	28	5
V46 11 72 PA 30	30	5,7

**WOK**

Wok

Alluminio forgiato / Forged aluminum

	Ø Cm	H Cm
V46 11 72 WO 28	28	7,5

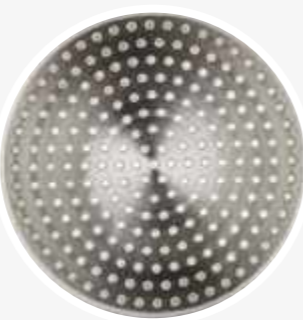

IDONEO PER TUTTI I PIANI DI COTTURA
compatible with all cooktops

COOKING STONE

in alluminio **forgiato** spessore mm 3,5, fondo a **induzione**, interno antiaderente con effetto pietra, manico soft-touch.

COOKING STONE

mm 3,5, **thickness, induction bottom, non-stick aluminum, stone effect inside/outside, soft touch handle.**



MANICO SOFT-TOUCH
soft-touch handle

**TEGAME 2 MANICI**

Sauce pan, 2-handle

Alluminio forgiato / Forged aluminum

	Ø Cm	H Cm
V46 11 72 TE 26	26	6,5

**CASSERUOLA 2 MANICI**

Casserole, 2-handle

Alluminio forgiato / Forged aluminum

	Ø Cm	H Cm	Lt
V46 11 72 CA 16	16	7,5	1,2
V46 11 72 CA 20	20	9,5	2,5

**CASSERUOLA 1 MANICO**

Casserole, 1-handle

Alluminio forgiato / Forged aluminum

	Ø Cm	H Cm	Lt
V46 11 72 CA 14	14	7,3	1



PADELLA 1 MANICO
Frying pan, 1-handle

Alluminio / Aluminum

	Ø Cm	H Cm
V65 11 72 PA 16	16	4
V65 11 72 PA 20	20	4,5
V65 11 72 PA 24	24	4,8
V65 11 72 PA 28	28	6
V65 11 72 PA 32	32	6



TEGAME
Saucepan, 1-handle

Alluminio / Aluminum

	Ø Cm	H Cm
V65 11 72 TE 30	30	7,5



FONDO ANTIADERENTE
non-stick



IDONEO PER TUTTI I PIANI DI COTTURA
compatible with all cooktops

EASY
spessore **2,2 mm**, fondo a **induzione**, interno antiaderente nero 2 strati, manico saldato in bachelite nero, colore esterno grigio.

EASY
2.2 mm thickness, induction bottom, non-stick 2-layer black inside, black bakelite welded handle, outside color: grey.

CASSERUOLA 2 MANICI
Casserole, 2-handle

Alluminio / Aluminum

	Ø Cm	H Cm	Lt
V65 11 72 CA 16	16	7,5	1,5
V65 11 72 CA 20	20	8,5	2,5
V65 11 72 CA 24	24	9,5	4



BOLLILATTE 1 MANICO
Casserole, 1-handle

Alluminio / Aluminum

	Ø Cm	H Cm	Lt
V65 11 72 BO 12	12	10	1



WOK 2 MANIGLIE

Wok, 2-handle

Alluminio pressofuso / Die-cast aluminum

	Ø Cm	H Cm	H Cm c/cop.
V82 11 72 W32 01	32	8,5	14,5

**WOK 1 MANICO, 1 MANIGLIA**

Wok, 1 long handle

Alluminio pressofuso / Die-cast aluminum

	Ø Cm	H Cm	H Cm c/cop.
V82 11 72 W32 02	32	8,5	14,5

**PADELLA CREPES**

Crepes frying pan

Alluminio pressofuso / Die-cast aluminum

	Ø Cm	H Cm	H Cm c/cop.
AVARI 083	28	2	10

**PAELLERA**

Paella pan

Alluminio / Aluminum

	Ø Cm	H Cm
V82 11 72 PL 26	26	4,1
V82 11 72 PL 30	30	4,2
V82 11 72 PL 34	34	4,5
V82 11 72 PL 38	38	4,5
V82 11 72 PL 42	42	5

**BISTECCHIERA/PIASTRA MULTIUSO**

Steak pan/Multipurpose pan

Alluminio forgiato / Forged Aluminum

	Ø Cm
V82 11 72 PP 28	28



BISTECCHIERA Steak pan

Alluminio pressofuso/Die-cast aluminum

	Cm
AVARI 084A	24x24
AVARI 084	28x28
AVARI 085	34x24

fondo a induzione/induction bottom



NUOVA BISTECCHIERA Steak pan

Alluminio pressofuso/Die-cast aluminum

	Cm
AVARI 085A	36x22,5
AVARI 085B	47x29

fondo a induzione/induction bottom



BISTECCHIERA Grill pan

Ghisa / Cast iron

	Ø Cm
V82 99 72 BT 24	24
V82 99 72 BT 27	27

con manico pieghevole
with foldable handle
idonea per tutti i piani di cottura
compatible with all cooktops



BISTECCHIERA Grill pan

Ghisa / Cast iron

	Cm
V82 99 72 BQ 24	24x24
V82 99 72 BQ 28	28x28

con manico pieghevole
with foldable handle
idonea per tutti i piani di cottura
compatible with all cooktops



BISTECCHIERA RETTANGOLARE Rectangular grill pan

Ghisa / Cast iron

	Cm
V82 99 72 BR 24	24x36

con manico pieghevole
with foldable handle
idonea per tutti i piani di cottura
compatible with all cooktops



TRIS LASAGNERA

Lasagna pan, 3-pc set

Carbon steel

	Cm	H Cm
V65 32 72 004	30x20	5
	32x22	5,5
	34x24	6



TRIS TEGLIE

Oven pan, 3-pc set

Carbon steel

	Cm	H Cm
V65 32 72 005	28,5x19,5	3,5
	31,5x21,5	3,8
	34x24	4

COPERCHIO CON POMOLO NERO

Lid with black knob

Vetro / Glass

	Ø Cm
906 05 083A	14
906 05 077A	16
906 05 078A	18
906 05 059A	20
906 05 060A	22
906 05 061A	24
906 05 062A	26
906 05 063A	28
906 05 079A	30
906 05 084A	32



VALVOLA DI SFIATO
vent valve

COPERCHIO CON POMOLO IN ACCIAIO

Lid with stainless steel knob

Vetro / Glass

	Ø Cm
906 05 090	14
906 05 091	16
906 05 092	18
906 05 093	20
906 05 094	22
906 05 095	24
906 05 096	26
906 05 097	28
906 05 098	30



VALVOLA DI SFIATO
vent valve





PENTOLE ACCIAIO

PENTOLA DAILY PLUS
Daily Plus Pot

TEGAME DAILY PLUS
Daily Plus Frying Pan



CASSERUOLA 1 MANICO

Casserole, 1-handle

Inox 18|10 / St. Steel

	Ø Cm	H Cm	Lt
V59 11 72 CA 14	14	7	1
V59 11 72 CA 16	16	8	1,5



CASSERUOLA 2 MANICI

Casserole, 2-handle

Inox 18|10 / St. Steel

	Ø Cm	H Cm	Lt
V59 11 72 CA 18	18	9	2,3
V59 11 72 CA 20	20	10	3
V59 11 72 CA 22	22	11	4
V59 11 72 CA 24	24	12	5



TEGAME 2 MANICI

Frying pan, 2-handle

Inox 18|10 / St. Steel

	Ø Cm	H Cm	Lt
V59 11 72 TE 24	24	6	2,5
V59 11 72 TE 26	26	7,5	3,5
V59 11 72 TE 28	28	7,5	3,7



PENTOLA

Pot

Inox 18|10 / St. Steel

	Ø Cm	H Cm	Lt
V59 11 72 PE 20	20	11,5	3,7
V59 11 72 PE 22	22	12,5	4,5
V59 11 72 PE 24	24	13,5	6
V59 11 72 PE 26	26	20	10,5
V59 11 72 PE 28A	28	20	12
V59 11 72 PE 30	30	22	15



DAILY PLUS

le pentole della linea Daily Plus sono prodotte utilizzando **acciaio inossidabile 18|10** di alta qualità, molto resistente alla corrosione, altamente compatibile con ogni alimento, igienico e facile da pulire, con **fondo a induzione**.

DAILY PLUS

cookware Daily Plus line is made of high quality **18|10 stainless steel**, corrosion resistant, highly compatible with food contact, hygienic and easy to clean, induction bottom.



FONDO A INDUZIONE
induction suitable bottom



BOLLILATTE

Milk pot

Inox 18|10 / St. Steel

	Ø Cm	H Cm	Lt
V59 11 72 BO 14	14	12	1,6



CESTELLO

Basket

Inox 18|10 / St. Steel

	Ø Cm	H Cm
V59 11 72 CE 22	22	9
V59 11 72 CE 24	24	9,5



CASSERUOLA

Casserole

Inox 18|CR / St. Steel

	Ø Cm	H Cm	Lt
V64 06 72 C 18	18	9	2
V64 06 72 C 20	20	10	3
V64 06 72 C 22	22	11	3,7
V64 06 72 C 24	24	12	4,5



TEGAME

Saucepan

Inox 18|CR / St. Steel

	Ø Cm	H Cm	Lt
V64 06 72 T 28	28	7	3,8



CASSERUOLE

Casserole

Inox 18|CR / St. Steel

	Ø Cm	H Cm	Lt	Pz
V64 06 72 C 12	12	8,2	0,8	1
V64 06 72 C 14	14	9	1,5	1
V64 06 72 C 16	16	10	1,8	1
V64 06 72 B 14	14	11,5	3,51	bollilatte / milkpot



HOT POT

pentole in acciaio inox, triplo fondo a induzione, manico saldato in bachelite nero

HOT POT

stainless steel, 3-layers induction bottom, black non-stick welded handle.



MANICO IN BACHELITE
bachelite handle

PENTOLA

Pot

Inox 18|CR / St. Steel

	Ø Cm	H Cm	Lt
V64 06 72 P 20	20	16	4,5
V64 06 72 P 22	22	18	6,2
V64 06 72 P 24	24	19	8



PADELLA 1 MANICO

Frying pan, 1-handle

Inox 18|CR / St. Steel

	Ø Cm	H Cm	Lt
V64 06 72 E 24	24	6,5	2,4
V64 06 72 E 28	28	7	3,8



COUSCOUSSIERA
Couscous Pot

**COTTURE
SPECIALI**





FRIGGITRICE QUADRATA

Square fryer

Alluminio + Acciaio 18|10/Aluminum + 18|10 St. Steel

	Cm	H Cm
V82 11 72 CO 01	28x28	9



FRIGGITRICE QUADRATA

Grazie alla peculiare forma quadrata, questo prodotto antiaderente risulta più capiente rispetto alle altre pentole, offrendoti la possibilità di cucinare in modi diversi svariate quantità di cibo. Grazie ai 4 pezzi che la compongono, potrai utilizzare la pentola per friggere, brasare, rosolare, bollire e cuocere in forno. IL FONDO È IDONEO ALLA COTTURA AD INDUZIONE.

SQUARE FRYER

Thanks to its peculiar shape, this non-stick product is more capacious than other pans, allowing to cook in different ways various quantities of food. Thanks to the 4 pieces it is made of, you will be able to use this fryer to fry, braise, brown, boil and bake. THE BOTTOM IS SUITABLE FOR INDUCTION.



COPERCHIO / LID



CESTELLO / BASKET



VAPORIERA / STEAMER



PENTOLA / PAN

PENTOLA PRESSIONE

Pressure cooker

Acciaio Inox 18|10 / 18|10 St. Steel

	Ø Cm	H Cm	Lt
906 05 069	20	20	3,5
906 05 070	22	20	5
906 05 071	22	26	7
906 05 072	22	32	9



PASTAIOLA CON CESTELLO

Pasta pot with basket

Acciaio Inox 18|10 / 18|10 St. Steel

	Ø Cm	H Cm	Lt
V59 11 72 PA 22	22	26,5	6
V59 11 72 PA 24	24	27,5	7,5

4 VALVOLE DI SICUREZZA
4 security valvesVALVOLA DI SFIATO
breather valve

PENTOLA A PRESSIONE

pentola a pressione in acciaio **inox 18|10** con 4 valvole di sicurezza, triplo fondo a **induzione** e manico ergonomico.

PRESSURE COOKER

18|10 stainless steel pressure cooker with 4 safety valves, triple **induction** bottom and ergonomic handle.

COPERCHIO IN VETRO
glass lid

PASTAIOLA

In **acciaio inossidabile 18/10**, ideale per la cucina di tutti i giorni, grazie al **pratico cestello** che permette di togliere la pasta già scolata, **con fondo capsulato a induzione** e coperchio in vetro e pomolo in acciaio inox.

PASTA POT

Made with **stainless steel 18/10**, ideal for everyday cooking, thanks to the **practical basket** that allows you to remove the pasta already drained, with **induction capsulated bottom** and glass lid with stainless steel knob.

CESTELLO IN ACCIAIO INOX 18|10
18|10 stainless steel basket

COUSCOUSSIERA E

VAPORIERA

pentola in acciaio **inox 18|10** con triplo fondo a **induzione** e con cestelli sovrapponibili con il fondo forato, per consentire il passaggio del vapore (1 cestello per la vaporiera e 2 cestelli per la cuscussiera), coperchio in vetro con valvola di sfiato vapore.

COUSCOUS POT AND
STEAM POT

18|10 stainless steel pot with **induction** bottom with stackable baskets with perforated bottom, to allow the steam exit (1 basket for the Steam Pot and 2 baskets for the Couscous Pot), glass lid and steam release valve.



COUSCOUSSIERA

Couscous pot

Acciaio Inox 18|10 / 18|10 St. Steel

	Ø Cm	H Cm	Lt
V59 11 72 CU 22	22	36	5
V59 11 72 CU 26	26	36,5	10



VAPORIERA

Steam pot

Acciaio Inox 18|10 / 18|10 St. Steel

	Ø Cm	H Cm	Lt
906 05 031	22	30	6
906 05 031G	24	33	8



PASTA POT

Pasta pot

Acciaio Inox 18|10 / 18|10 St. Steel

	Ø Cm	H Cm	Lt
906 05 074	22	21,5	5



ASPARAGERA

Asparagus pot

Acciaio Inox 18|CR / St. Steel

	Ø Cm	H Cm	Lt
V64 06 72 A 16	16	21	4



PASTAIOLA

Pasta pot

Acciaio Inox 18|CR / St. Steel

	Ø Cm	H Cm	Lt
V64 06 72 PA 20	20	23,5	4,7
V64 06 72 PA 22	22	25	6,2



ASPARAGERA

in acciaio inossidabile 18/CR con manici, coperchio in vetro, **fondo a induzione**. Puoi cucinare asparagi, verdure e realizzare piatti della tradizione utilizzando il vapore e la cottura ad acqua. Per ricette saporite, nutrienti e dietetiche.

ASPARAGUS POT

*Stainless steel with handle, glass lid, **induction bottom**. You can cook asparagus, vegetables and prepare traditional dishes through steam and water cooking. For tasty, nutritious and dietetic recipes.*

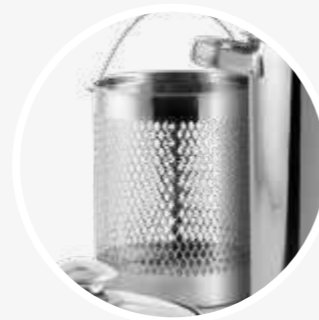

CESTELLO IN ACCIAIO INOX
stainless steel basket

PASTAIOLA

In acciaio inox 18/CR, ideale per la cucina di tutti i giorni, grazie al pratico cestello che permette di togliere la pasta già scolata, con fondo capsulato a induzione e coperchio in vetro e pomolo in acciaio inox.

PASTA POT

*Made with **stainless steel**, ideal for everyday cooking, thanks to the **practical basket** that allows you to remove the pasta already drained, with **induction capsulated bottom** and glass lid with stainless steel knob.*



CESTELLO IN ACCIAIO INOX
stainless steel basket

VAPORIERA

La soluzione **ideale per cotture a vapore veloci, facili e salutari**, grazie al doppio piano di cottura, il fondo adatto per piani a induzione, il coperchio in vetro con valvola di sfiato e le pratiche maniglie, la vaporiera HotPot permette di cuocere il cibo in modo sano e naturale, preservando ogni sapore e proprietà.

STEAMER

*The best solution **for easy, fast and healthy steam cooking**, thanks to a double cooktop, suitable induction bottom, glass lid with vent valve and practical handles, the HotPot steamer allows to cook in a natural and healthy way, while maintaining the food taste and properties.*



IDONEO PER TUTTI I PIANI DI COTTURA
compatible with all cooktops

COPERCHIO FORATO

fores lid



PASTA POT CUOCI/SCOLA

in acciaio inox, fondo a **induzione**, coperchio scolapasta. Sistema di bloccaggio coperchio mediante gli appositi manici per scolare in tutta facilità e sicurezza.

PASTA POT COOK/DRAIN

*Stainless steel, **induction bottom**, lid colander. Locking-lid system through suitable steady handles, allowing to drain easily and safely.*

VAPORIERA HOT POT

Hot Pot steamer

Acciaio Inox 18|CR con cestello / St. Steel with basket

	Ø Cm	H Cm	Lt
V64 06 72 VA 20	20	23,5	3,5
V64 06 72 VA 22	22	28	5,5



PASTA POT CUOCI/SCOLA

Pasta pot / Cook | Drain

Acciaio Inox 18|CR / St. Steel

	Ø Cm	H Cm	Lt
V64 06 72 PP 24	24	13	5,5

Pentola a pressione che permette una rapida cottura degli alimenti grazie alle alte temperature che può raggiungere. Con l'aiuto della riduzione considerevole del tempo di cottura le sostanze nutritive degli alimenti come proteine, sali minerali e vitamine, si mantengono quasi inalterate. Un ottimo alleato per tutti i tipi di cucina. Facile da usare. Triplo fondo a induzione. 2/3 valvole di sicurezza.

A cooking vessel that facilitates the rapid cooking of food due to the high temperatures reached inside it. With these temperatures, food can be cooked in considerably less time resulting in remarkable savings of time and energy. Food nutrients are much better preserved. Easy to use. Triple induction bottom. 2/3 security valves.



APERTURA E CHIUSURA FACILITATE
easy opening and closing



TIMER DIGITALE
digital timer



APERTURA E CHIUSURA FACILITATE
easy opening and closing



VALVOLA DI SICUREZZA
safety valve



INTERNO GRADUATO
graduated inside



VALVOLA DI CONTROLLO PRESSIONE
pressure control valve



VALVOLA DI REGOLAZIONE PRESSIONE
pressure control and vent valve

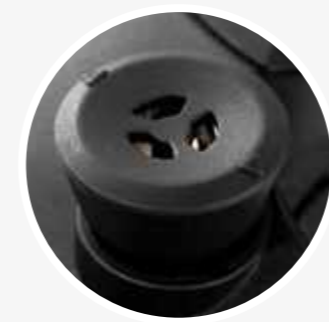

VALVOLA DI SICUREZZA E SFIATO
safety and vent valve



PENTOLA PRESSIONE TIME

Time pressure cooker

Inox 18|10 / St. Steel

	Ø Cm	H Cm	Lt
V69 05 72 P04	23	11,5	4



PENTOLA PRESSIONE MODERN

Modern pressure cooker

Inox 18|10 / St. Steel

	Ø Cm	H Cm	Lt
V45 05 72 P04	23	14,5	4
V45 05 72 P06	23	17	6





PENTOLA PRESSIONE JADORE

Jadore pressure cooker

Acciaio inox 18|10 / 18|10 St. Steel

	Ø Cm	H Cm	Lt
V79 05 72 P 05	22	13	5
V79 05 72 P 07	22	19	7



PENTOLA A PRESSIONE JADORE

pentola a pressione in acciaio inox 18|10 con triplo fondo a induzione, 4 valvole di sicurezza con blocco apertura coperchio.

PRESSURE COOKER JADORE

18|10 stainless steel pressure cooker with triple induction bottom, 4 safety valves and lid opening lock.



3 VALVOLE DI SICUREZZA
4 security valves



BLOCCO COPERCHIO
block opening system



ACCIAIO INOX 18|10
18|10 stainless steel

PENTOLA A PRESSIONE HOT POT

con 3 valvole di sicurezza con blocco apertura in acciaio inox 18|10, triplo fondo a induzione.

PRESSURE COOKER HOT POT

with 3 security valves with opening block system, in 18|10 stainless steel, sandwich induction bottom, in box.



3 VALVOLE DI SICUREZZA
3 security valves



3 VALVOLE DI SICUREZZA
3 security valves

PENTOLA A PRESSIONE EASY

La pentola a pressione in acciaio inox 18|CR, con triplo fondo a induzione, 3 valvole di sicurezza e blocco apertura. Permette una rapida cottura degli alimenti grazie alle alte temperature che può raggiungere.

EASY PRESSURE COOKER

18|10 stainless steel pressure cooker with sandwich induction bottom, 3 security valves and opening block system. It facilitates the rapid cooking of food due to the high temperatures reached inside it.

PENTOLA PRESSIONE HOT POT

Hot Pot pressure cooker

Acciaio inox 18|10 / 18|10 St. Steel

	Ø Cm	H Cm	Lt
V64 05 72 PP 3	20	20	3,5
V64 05 72 PP 5	20	23	5
V64 05 72 PP 7	22	26,5	7



PENTOLA PRESSIONE EASY

Easy pressure cooker

Acciaio inox 18|CR / St. Steel

	Ø Cm	H Cm	Lt
V65 06 72 PP 03	20	20	3,5
V65 06 72 PP 05	20	23	5
V65 06 72 PP 07	22	26,5	7



COPERCHIO

Lid

Acciaio inox 18|CR / St. Steel



	Cm
V65 06 15 C14	14
V65 06 15 C16	16
V65 05 15 C18	18
V65 05 15 C20	20
V65 05 15 C22	22
V65 05 15 C24	24
V65 05 15 C26	26
V65 05 15 C28	28
V65 05 15 C30	30
V65 05 15 C32	32

**CASSERUOLA 1 MANICO**

Casserole, 1-handle

Acciaio inox 18|CR / St. Steel

	Ø Cm	H Cm	Lt
V65 06 72 CA 12	12	6,5	0,45
V65 06 72 CA 14	14	7	0,7
V65 06 72 CA 16	16	7,5	0,95

**CASSERUOLA 2 MANICI**

Casserole, 2-handles

Acciaio inox 18|CR / St. Steel

	Ø Cm	H Cm	Lt
V65 06 72 CA 18	18	8,5	1,4
V65 06 72 CA 20	20	9,8	2
V65 06 72 CA 22	22	10,2	2,5

PIROFILA DA FORNO OVALE C/MANIGLIE

White baking dish, oval with handles

	Cm	H Cm
VA37 00 18 85	27x17	4,5
VA37 00 06 72	31x20	5
VA37 00 06 55	34x21	5,5
VA37 00 06 39	38x24	5,5
VA37 00 06 31	42x26,5	6,5

**PIROFILA DA FORNO OVALE**

White baking dish, oval

	Cm	H Cm
VA37 00 00 38	24,5x16,5	5
VA37 00 00 28	29x19,5	5,5
VA37 00 18 72	33x23	5,5
VA37 00 24 51	39,5x29,5	5,5

**PIROFILA DA FORNO RETTANGOLARE C/MANIGLIE**

White baking dish, rectangular with handles

	Cm	H Cm
VA37 00 15 73	25x18	5
VA37 00 07 11	30x21	5
VA37 00 06 95	34x23	6

**STAMPO PER CROSTATA**

White tart mould

	Ø Cm
VA38 00 03 76	29
VA38 00 03 95	26
VA38 00 15 67	21,5
VA38 00 04 12	12



SET PIATTI ALGARVE 12 PZ

12-pc set Algarve plates composition

		Ø Cm
VASETALG 01	4 piatti piani / 4 flat plates	24
	4 piatti frutta, dessert/ 4 fruit, dessert plates	19
	4 piatti fondi / 4 soup plates	21

**SET PIATTI ALGARVE 18 PZ**

18-pc set Algarve plates composition

		Ø Cm
VASETALG 02	6 piatti piani / 4 flat plates	24
	6 piatti frutta, dessert/ 4 fruit, dessert plates	19
	6 piatti fondi / 4 soup plates	21

**SET PIATTI ESTORIL 12 PZ**

12-pc set Estoril plates composition

		Ø Cm
VASETEST 01	4 piatti piani / 4 flat plates	25
	4 piatti frutta, dessert/ 4 fruit, dessert plates	19
	4 piatti fondi / 4 soup plates	23

**SET PIATTI ESTORIL 18 PZ**

18-pc set Estoril plates composition

		Ø Cm
VASETEST 02	6 piatti piani / 4 flat plates	25
	6 piatti frutta, dessert/ 4 fruit, dessert plates	19
	6 piatti fondi / 4 soup plates	23

**SET PIATTI PERLA 12 PZ**

12-pc set Perla plates composition

		Ø Cm
VASEPER 01	4 piatti piani / 4 flat plates	27
	4 piatti frutta, dessert/ 4 fruit, dessert plates	21
	4 piatti fondi / 4 soup plates	24

**SET PIATTI PERLA 18 PZ**

18-pc set Perla plates composition

		Ø Cm
VASEPER 02	6 piatti piani / 4 flat plates	27
	6 piatti frutta, dessert/ 4 fruit, dessert plates	21
	6 piatti fondi / 4 soup plates	24



abert^{BY} Promab

Promab S.r.l.

📍 Via Don P. Mazzolari, 17 25050 Passirano (Bs) Italy

☎ +39 030 6853611

📠 +39 030 6577194

✉ info@abert.it

🌐 abert.it

abert_{RY} Promab



VISTA ALEGRE

1824



TRADE

HOTELWARE



Legendas | Subtitles | Subtítulos | Légendes

Medidas Europeias
European Measurements
Dimensiones Europeas
Mesures Européennes

Medidas Americanas
U.S.A. Measurements
Dimensiones Americanas
Mesures Américaines

△ (gr) - Peso | Weight | Poids
A (mm) - Altura | Height | Hauteur
C (mm) - Comprimento | Length | Longitud | Longueur
L (mm) - Largura | Width | Ancho | Largeur
Ø (mm) - Diâmetro | Diameter | Diámetro | Diamètre
CAP (ml) - Capacidade | Capacity | Capacidad | Contenance

△ (lbs) - Peso | Weight | Poids
H (") - Altura | Height | Hauteur
L (") - Comprimento | Length | Longitud | Longueur
W (") - Largura | Width | Ancho | Largeur
Ø (") - Diâmetro | Diameter | Diámetro | Diamètre
CAP (oz) - Capacidade | Capacity | Capacidad | Contenance

ÍNDICE

INDEX | TABLE DES MATIÈRES

Especificações · <i>Specifications</i> · <i>Especificaciones</i> · <i>Caractéristiques</i>	2
Index	4
Cronologia · <i>Chronology</i> · <i>Cronología</i> · <i>Chronologie</i>	6
Design for Taste	10
Vista Alegre Hotelware	12
ESSENTIAL	14
DECORATIONS	60
CONTEMPORARY <i>Porcelana</i> · <i>Porcelain</i> · <i>Porcelaine</i>	82
CONTEMPORARY <i>Grés</i> · <i>Stoneware</i> · <i>Grès</i>	140
SIGNATURE	178
EXCELLENCE	222
FORNO <i>Ovenware</i> · <i>Horno</i> · <i>Four</i>	238
VIDRO <i>Glass</i> · <i>Vidrio</i> · <i>Verre</i>	254
DECORATIVO <i>Gift</i> · <i>Décoration</i>	264
CUTELARIA <i>Cutelary</i> · <i>Cubiertos</i> · <i>Couverts</i>	270
Agradecimentos · <i>Special thanks</i> · <i>Agradecimentos</i> · <i>Remerciements</i>	294
Ficha técnica · <i>Credits</i> · <i>Ficha técnica</i> · <i>Fiche technique</i>	295
Contactos · <i>Contacts</i>	296

ESPECIFICAÇÕES



Resistente ao micro-ondas

*Microwaves safe
Microondas seguro
Résistant au micro-ondes*



Não usar no micro-ondas

*Not suitable for microwaves
No se puede usar en el microondas
Ne pas utiliser au micro-ondes*



O uso frequente do micro-ondas pode causar alterações no vidrado das peças

*Frequent microwave usage may cause changes in glazing
El uso frecuente del microondas puede causar cambios en el vidrado de las piezas
Un usage fréquent au micro-ondes peut modifier la couleur de l'émail des produits*



Resistente à máquina de lavar

*Dishwasher safe
Se puede lavar en lavavajillas
Résistant au lave-vaisselle*



Não é resistente à máquina de lavar

*Not suitable for dishwasher
No se puede lavar en lavavajillas
Ne pas utiliser au lave-vaisselle*



Na lavagem à máquina aconselhamos ciclos curtos a baixas temperaturas Evitar lavagens frequentes

*For dishwashing we advise short cycles at low temperatures
Avoid frequent use in dishwashing
Se aconseja programas cortos y a bajas temperaturas en lavavajillas
Evitar lavados frecuentes
Au lave-vaisselle utiliser des cycles courts a basse température
Eviter les lavages fréquents*



Sugere-se manipulação cuidada (impacto no bordo)

*Careful handling suggested (impacto on the edge)
Se sugiere manipulación cuidada (impacto en el borde)
Il est suggéré une manipulation soigneuse (impact sur le bord)*





INDEX



Gold Stone	156
Imperfect White	160
Iris	162
Lagoon	164
Noir	166
Rustic Blend	168
Sauvage	172
Shine	174
Whisper	176

ESSENTIAL

Porcelana | Porcelain | Porcelana

Algarve	16
Bragança	18
Coimbra	22
Escorial	28
Estoril	32
Europa	38
Luna	42
Perla	48
Sagres	54
Virtual	58



CONTEMPORARY

Porcelana | Porcelain | Porcelana

Accessories	84
Asia	86
Broadway	88
Buffet	92
Carré	94
Fiord	98
Gourmet	100
Karma	104
Kyoto	106
Multiforma by Mikaela Dörfel	108
Natura Line by Chef Vitor Matos	114
Optima	116
Organic	118
Rin by Reiko Kaneko	122
Spirit Hotel	124
Synergy	130
Tapas & Sushi	132
Utopia	136



CONTEMPORARY

Grês | Stoneware | Gres

Amazônia with Ecoarts	142
Bronze	146
Corval	148
Exuberant	150
Floral Scent	152
Food Concept	154



SIGNATURE

Porcelana | Porcelain | Porcelana

Chefs' Collection	180
Couvert by Vitor Sobral	184
Infinita by Carsten Gollnick	186
Maré Alta by Magdalena Kraska	188
Marés by Carsten Gollnick	190
Matrix by Bartek Mejor	192
Mineral by Sylvie Coquet	194
O! Moon by Santos Bregaña	196
Saturn by Carsten Gollnick	198
Silica	200
South by Carsten Gollnick	204
Tecido by Gonçalo Campos	208
Temptation by Sylvie Coquet	210
Texture by Mieke Cuppen	212
Theatre by FROM	214
Stroke by FROM	216
Trace by Carsten Gollnick	218
Vernissage by Carsten Gollnick	220



EXCELLENCE

Porcelana | Porcelain | Porcelana

Domo	224
Modo White	228
Silk Road by Carsten Gollnick	232



FORNO

Porcelana | Porcelain | Porcelana

Azure	240
Buffet	241
Cuisine	242
Luna	245
Organic	246

Grès | Stoneware | Grès

Classic	247
Festival	250
Fiorenza	251
Fusion	252
True Scale	253



VIDRO

Glass | Vidrio | Verre

Aroma	256
Bicos	258
Bicos Bicolor	260
Campania	261
Dunes	262
Nature	262
Organico	263



DECORATIVO

Gift | Décoration

Stars by Martina Süsse	266
Porcelana Decorativa	268



CUTELARIA

Cutelary | Cubiertos | Couverts

Domo	272
Domo Matt	274
Domo Handle Matt Gold	276
Elegance	278
Linea	280
Plazza	282
Prism	284
Spa	286
Vega	288
Velvet	290
Velvet Matt	292

CRONOLOGIA

CHRONOLOGY CRONOLOGÍA CHRONOLOGIE

1824



Fundação da 1ª fábrica dedicada à produção de porcelana em Portugal, em Ílhavo, perto de Aveiro, por José Ferreira Pinto Basto.

In the town of Ílhavo, near Aveiro, José Ferreira Pinto Basto founds the first factory in Portugal dedicated to the manufacture of porcelain.

Fundación de la primera fábrica dedicada a la producción de porcelana en Portugal, en Ílhavo, cerca de Aveiro, por José Ferreira Pinto Basto.

José Ferreira Pinto Basto fonde la 1ère usine dédiée à la production de porcelaine au Portugal à Ílhavo, près d'Aveiro.



1829

Atribuição à Vista Alegre do título de Real Fábrica, um reconhecimento pela sua arte e sucesso industrial.

Vista Alegre is granted the title of Royal Factory, recognition of its artistry and industrial success.

Asignación del título de Real Fábrica a Vista Alegre, un reconocimiento por su arte y su éxito industrial.

Attribution du titre de Real Fábrica à Vista Alegre, une reconnaissance de son art et sa réussite industrielle.



1835

Contratação do pintor Victor Rousseau e criação da Escola de Pintura.

French painter and designer Victor Rousseau is hired and founds the first School of Manual Painting in the factory.

Contratación del pintor Victor Rousseau y creación de la escuela de pintura.

Recrutement du peintre Victor Rousseau et création de l'École de Peinture.

1972



Nascimento das primeiras peças de cristal Atlantis na fábrica de Alcobaça, distinguindo-se pela produção de um dos melhores cristais de chumbo de fabrico manual em todo o mundo.

The first pieces of Atlantis crystal are made in the Alcobaça factory, which stands out for the production of one of the best hand-made lead crystals in the world.

Nacimiento de las primeras piezas de cristal Atlantis en la fábrica de Alcobaça, que se destaca por la producción de uno de los mejores cristales de plomo de fabricación manual de todo el mundo.

Naissance des premiers objets en cristal Atlantis dans l'usine d'Alcobaça, produisant l'un des meilleurs cristaux à base de plomb fabriqué à la main dans le monde entier.



1980

Lançamento das primeiras séries limitadas e reproduções para museus.

The first limited series and reproductions for museums are launched.

Lanzamiento de las primeras series limitadas y reproducciones para museos.

Lancement des premières éditions limitées et des reproductions destinées aux musées.

1984-1985



Exposição "Portugal and Porcelain" no Metropolitan Museum of Art (The Met) em Nova Iorque.

The Metropolitan Museum of Art (The Met), in New York, welcomes the "Portugal and Porcelain" exhibition.

Exposición "Portugal and Porcelain" en el Metropolitan Museum of Art (The Met) en Nueva York.

Exposition "Portugal and Porcelain" au Metropolitan Museum of Art (The Met) à New York.

2009



Aquisição pelo Grupo Visabeira do Grupo Vista Alegre Atlantis, refletindo-se num forte reinvestimento humano e tecnológico.

Acquisition of Grupo Vista Alegre Atlantis by Grupo Visabeira, leading to a major investment in technology and human resources.

Adquisición del Grupo Visabeira del Grupo Vista Alegre Atlantis, reflejándose en una fuerte inversión humana y tecnológica.

Visabeira acquiert le Groupe Vista Alegre Atlantis, ce qui représente un important réinvestissement humain et technologique.



2010

Forte aposta na internacionalização e no design, através de diversas parcerias com criadores de renome, e na abertura de lojas, showrooms e corners em vários países.

Strong focus on internationalization and design through several partnerships with renowned designers, and the opening of stores, showrooms and sales corners in several countries.

Fuerte apuesta por la internacionalización y el diseño, a través de diversas colaboraciones con creadores de renombre, y en la apertura de tiendas, showrooms y corners en varios países.

Accent mis sur l'internationalisation et la conception, grâce à divers partenariats avec des créateurs reconnus, et l'ouverture de magasins, showrooms et corners dans plusieurs pays.



1880



Cessação da produção de vidro e reconversão da fábrica para fabrico exclusivo de porcelana.

End of glass production and conversion of the factory for the exclusive manufacture of porcelain.

Cese de la producción de vidrio y adaptación de la fábrica para la fabricación exclusiva de porcelana.

Suspension de la production de verre et conversion de l'usine en vue de la fabrication exclusive de porcelaine.

1957



Abertura da primeira loja Vista Alegre, nos números 20 e 23, no Largo do Chiado, em Lisboa.

Vista Alegre opens its first store in Lisbon, at 20-23 Largo do Chiado.

Apertura de la primera tienda Vista Alegre, en Largo do Chiado, 20 y 23, en Lisboa.

Ouverture du premier magasin Vista Alegre, situé aux numéros 20 et 23, Largo do Chiado, à Lisbonne.

1964



Inauguração do Museu da Vista Alegre.

The Vista Alegre Museum is inaugurated.

Inauguración del Museo de Vista Alegre.

Ouverture du Musée Vista Alegre.

1985



Criação do Clube do Colecionadores (limitado a 2.500 sócios), refletindo a importância da Vista Alegre no mercado da arte.

Creation of the Vista Alegre Collectors Club (limited to 2.500 members), reflecting the brand's relevance in the art market.

Creación del Club de Coleccionistas (limitado a 2.500 socios), reflejando la importancia de Vista Alegre en el mercado del arte.

Création du Club des Collectionneurs (limité à 2500 membres), ce qui reflète l'importance de Vista Alegre au sein du marché de l'art.



Fusão com o grupo cerâmico Cerexport, quase duplicando o volume de negócios, com maior incidência no mercado externo.

Merger with Cerexport ceramic group, almost doubling the company's turnover, especially as concerning the foreign market.

Fusión con el grupo cerámico Cerexport, duplicando casi el volumen de negocios, con mayor incidencia en el mercado externo.

Fusion avec le groupe céramique Cerexport, ce qui a pratiquement doublé le chiffre d'affaires, ayant une incidence plus importante sur les marchés étrangers.

2001



Fusão do Grupo Vista Alegre com o Grupo Atlantis, tornando-se o maior grupo nacional de tableware e o sexto maior do mundo no setor.

Fusion of Grupo Vista Alegre with Grupo Atlantis, resulting in the largest national tableware group and the sixth largest group in this sector worldwide.

Fusión del Grupo Vista Alegre con el Grupo Atlantis, convirtiéndose en el mayor grupo nacional de producción de vajillas y en el sexto mayor del mundo en dicho sector.

Fusion du Groupe Vista Alegre avec le Groupe Atlantis, devenant, en matière d'arts de la table, le plus grand groupe national et le sixième dans le monde.

2010



Inauguração da primeira flagship store em Madrid, na Calle Ortega y Gasset.

First flagship store opened in Madrid, on Calle Ortega y Gasset.

Inauguración de la primera flagship store en Madrid, en la Calle Ortega y Gasset.

Inauguration du premier flagship store à Madrid, dans la Calle Ortega y Gasset.



Criação do ID Pool – International Design Pool, o laboratório criativo da Vista Alegre constituído por jovens designers de todo o mundo.

Creation of ID Pool – International Design Pool, Vista Alegre's creative lab, including young designers from all over the world.

Creación del ID Pool – International Design Pool, el laboratorio creativo de Vista Alegre, compuesto por jóvenes diseñadores de todo el mundo.

Création de l'ID Pool – International Design Pool, le laboratoire créatif de Vista Alegre qui se compose de jeunes designers du monde entier.

2013



Relançamento da marca Casa Alegre, com um conceito inspirado na cultura mediterrânica, traduzindo o estilo de vida no sul da Europa, fortemente influenciado pelo sol e o mar.

Casa Alegre brand relaunch, with a concept inspired by Mediterranean culture, mirroring the lifestyle of southern Europe, where the sun and the sea are powerful influences.

Relanzamiento de la marca Casa Alegre, con un concepto inspirado en la cultura mediterránea, traduciendo el estilo de vida en el sur de Europa, con gran influencia del sol y del mar.

Relance de la marque Casa Alegre, avec un concept inspiré par la culture méditerranéenne, reflétant le style de vie en Europe du Sud, très influencé par le soleil et la mer.

CRONOLOGIA

CHRONOLOGY CRONOLOGÍA CHRONOLOGIE

2013



Abertura do showroom da marca em Nova Iorque, na 41 Madison Avenue.

Opening of the brand's showroom in New York, at 41 Madison Avenue.

Apertura del showroom de la marca en Nueva York, en la 41 Madison Avenue.

Ouverture du showroom de la marque à New York, au 41 Madison Avenue.



2013

Reestruturação profunda da plataforma de eCommerce da marca, dotando-a de uma imagem renovada e de múltiplas novas funcionalidades.

Major restructuring of the brand's e-Commerce platform, providing it with a fresh image and several new features.

Reestructuración profunda de la plataforma de eCommerce de la marca, dotándola de una imagen renovada y de múltiples y nuevas funcionalidades.

Restructuration de la plate-forme de commerce électronique de la marque, lui donnant une image renouvelée et plusieurs nouvelles fonctionnalités.

2014



Vista Alegre comemora 190 anos de existência.

Vista Alegre celebrates its 190th anniversary.

Vista Alegre conmemora 190 años de existencia.

Vista Alegre célèbre 190 ans d'existence.

2015



Abertura da unidade hoteleira de 5 estrelas Montebelo Vista Alegre Ilhavo Hotel, inaugurada pelo Presidente da República Portuguesa, Marcelo Rebelo de Sousa.

Opening of the 5-star Montebelo Vista Alegre Ilhavo Hotel, inaugurated by the President of the Portuguese Republic, Mr. Marcelo Rebelo de Sousa.

Apertura del complejo hotelero de 5 estrellas Montebelo Vista Alegre Ilhavo Hotel, inaugurado por el presidente de la República Portuguesa, Marcelo Rebelo de Sousa.

L'ouverture de l'hôtel 5 étoiles Montebelo Vista Alegre Ilhavo Hotel, inauguré par le Président Portugais, Marcelo Rebelo de Sousa.

2015



Inauguração da nova loja em Madrid, na Calle de Claudio Coello, 53. Abertura da flagship store em Barcelona, na Rambla Catalunya 57.

Opening of the brand's new store in Madrid, at 53 Calle de Claudio Coello. Opening of the brand's flagship store in Barcelona, at 57 Rambla Catalunya.

Inauguración de la nueva tienda en Madrid, en la Calle de Claudio Coello, 53. Abertura da flagship store em Barcelona, na Rambla Catalunya 57.

Inauguração da nova loja em Madrid, na Calle de Claudio Coello, 53. Abertura da flagship store em Barcelona, na Rambla Catalunya 57.

2017



Lançamento da Loja Online para Profissionais.

The brand launches its online showroom aimed at the HORECA channel.

Lanzamiento de la tienda online para profesionales.

Lancement du Magasin En Ligne destiné aux clients professionnels.



A VAA completou a expansão do grupo adquirindo a Cerutil e a Bordallo Pinheiro, registando os melhores resultados de sempre. Reconhecimento internacional da marca com 21 Prémios de Design ganhos.

VAA completed the group expansion with the acquisition of Cerutil and Bordallo Pinheiro and registered the best results ever. International brand recognition with 21 Design Awards won.

VAA completó la expansión del grupo con la adquisición de Cerutil y Bordallo Pinheiro y registró los mejores resultados en toda su trayectoria. Reconocimiento de marca internacional, habiendo obtenido 21 premios de diseño.

VAA continué l'expansion du groupe en acquérant les sociétés Cerutil et Bordallo Pinheiro, et ses résultats ont été les meilleurs qu'elle n'ait jamais connus. La marque jouit d'une reconnaissance internationale et a remporté 21 prix de design.



2014



Abertura da primeira flagship store Vista Alegre no Brasil, em São Paulo.

Opening of Vista Alegre's first flagship store in Brazil, in the city of São Paulo.

Apertura de la primera flagship store Vista Alegre en Brasil, en São Paulo.

Ouverture du premier flagship store Vista Alegre au Brésil, à Sao Paulo.

2014



Inauguração da Fábrica Ria Stone em Ílhavo, produzindo louça em grés para a empresa sueca IKEA, destinada à exportação.

Inauguration of the Ílhavo-based Ria Stone factory, which manufactures stoneware mainly for exportation, being a supplier of the Swedish brand IKEA.

Inauguración de la Fábrica Ria Stone en Ílhavo, que produce porcelana de gres para la empresa sueca IKEA, destinada a la exportación.

Inauguration de l'usine Ria Stone à Ílhavo qui produit de la vaisselle en grès pour la société suédoise IKEA, destinée à l'exportation.

2015



Reabilitação de todo o património histórico e cultural do Lugar da Vista Alegre (Museu, Capela da Nossa Senhora da Penha de França, Teatro, Creche).

Rehabilitation of the entire historical and cultural heritage of the Place of Vista Alegre (Museum, Chapel of Our Lady of Penha de França, Theater, Nursery).

Rehabilitación de todo el patrimonio histórico y cultural de Vista Alegre (Museo, Capilla de Nuestra Señora de la Peña de Francia, Teatro, Guardería).

Réhabilitation de l'ensemble du patrimoine historique et culturel de la ville Vista Alegre (Musée, Chapelle Notre-Dame de Penha de França, Théâtre, Crèche).

2016



Rebranding da marca Atlantis, passando a oferta de cristal e vidro a ser comercializada sob a marca Vista Alegre.

Atlantis' rebranding, with its crystalware and glassware now sold under Vista Alegre's brand.

Rebranding de la marca Atlantis, pasando la oferta de cristal y vidrio a comercializarse con la marca Vista Alegre.

Rebranding de la marque Atlantis. Les produits en cristal et en verre sont désormais commercialisés sous le nom de la marque Vista Alegre.

2017



Abertura da Loja para Profissionais, destinada ao canal HORECA, na Av. João Crisóstomo, nº17, em Lisboa.

Opening of the brand's showroom aimed at the HORECA channel, at 17 Av. João Crisóstomo, in Lisbon.

Apertura de la tienda para profesionales, destinada al canal HORECA, en la Av. João Crisóstomo, n.º 17, en Lisboa.

Ouverture du Magasin destiné aux Clients Professionnels utilisant le canal HORECA (CHR), situé à Avenue João Crisóstomo, n° 17 à Lisbonne.

Atualmente, a Vista Alegre produz porcelana (tableware, decorativa, giftware e hotelware) e vidro e cristal de alta qualidade. Detendo 41 lojas próprias, incluindo 4 flagship stores (Lisboa, Madrid, Barcelona e São Paulo), um showroom em Nova Iorque, e contando com mais de 1.000 pontos de venda (corners e shop-in-shop) espalhados por 12 países, a marca alcança 70 nações.

Currently, Vista Alegre produces porcelain (tableware, giftware, hotelware, and decorative porcelain) and high quality glassware and crystalware. With 41 stores, including 4 flagship stores (Lisbon, Madrid, Barcelona and São Paulo), a showroom in New York and more than 1,000 points of sale (sales corners and shop-in-shop) across 12 countries, the brand is present in 70 nations.

Actualmente Vista Alegre produce porcelana (tableware, decorativa, giftware y hotelware) y vidrio y cristal de alta calidad. Cuenta con 41 tiendas propias, incluyendo 4 flagship stores (Lisboa, Madrid, Barcelona y São Paulo), un showroom en Nueva York, y más de 1000 puntos de venta (corners y shop-in-shop) repartidos por 12 países; la marca llega a 70 naciones.

À l'heure actuelle, Vista Alegre produit de la porcelaine (arts de la table, décoration, giftware et hotelware) ainsi que des objets en verre et en cristal de haute qualité. Avec 41 magasins, dont quatre flagship stores (Lisbonne, Madrid, Barcelone et Sao Paulo), un showroom à New York, et plus de 1000 points de vente (corners et shop-in-shop) répartis sur 12 pays, la marque est présente dans 70 nations.



DESIGN FOR TASTE

A gama Vista Alegre Hotelware oferece um distinto conjunto de produtos, desenvolvidos em parceria com prestigiados designers e chefs de renome nacional e internacional. Peças resistentes, funcionais e inovadoras, criadas para satisfazer os profissionais mais exigentes.

The Vista Alegre Hotelware ranges offers a distinctive set of products jointly developed with prestigious designers and renowned chefs worldwide. Resistent, functional, and innovative pieces bound to satisfy the most demanding professionals.

La gama de vajillas Vista Alegre para hostelería ofrece una gran variedad de productos, desarrollados en colaboración con prestigiosos diseñadores y chefs de nombre nacional e internacional. Piezas resistentes, funcionales e innovadoras, diseñadas para satisfacer a los profesionales más exigentes.

La gamme Hotelware de Vista Alegre offre un ensemble diversifié de produits, développés en partenariat avec des designers prestigieux et des chefs de renommée nationale et internationale. Des pièces résistantes, fonctionnelles et innovantes, créées pour satisfaire les professionnels les plus exigeants.



UMA MARCA DE EXIGÊNCIA

O crescimento progressivo da oferta e da procura no setor hoteleiro, bem como o consequente aumento da qualidade, incentivaram a Vista Alegre a investir neste segmento tão competitivo, encarando o turismo como uma extensão orgânica da sua atividade.

Sempre diferenciadores, os produtos de hotelware da Vista Alegre oferecem uma excelente relação qualidade/ preço, constituindo uma escolha aliciante nos segmentos médio, alto e de luxo. Para tal, associou-se à forte imagem da marca uma extrema atenção às necessidades do setor, patente em gamas diversificadas que combinam design contemporâneo, inovação técnica e as propriedades funcionais exigidas pelos melhores profissionais, entre as quais dimensão, volumetria, resistência e ergonomia.

O reconhecimento global, a colaboração frequente com designers prestigiados e os laços criados com chefs de renome internacional, com os quais desenvolve as suas coleções de hotelware, contribuem para fortalecer a associação da Vista Alegre à alta gastronomia e assegurar a sua presença nos principais grupos hoteleiros por todo o mundo, fazendo da marca líder no segmento de hotelware nos mercados do sul da Europa.

VISTA ALEGRE HOTELWARE



A DEMANDING BRAND

The progressive growth of supply and demand in the hotel sector, as well as the consequent increase in the quality, have encouraged Vista Alegre to invest in this highly competitive segment, viewing tourism as an organic extension of its activity.

Always distinctive, Vista Alegre hotelware offers an excellent quality/price relation, making it an attractive choice in the medium, high and luxury segments. To this end, the brand's strong image has been closely followed by the needs of the industry, with a range of diversified ranges that combine contemporary design, technical innovation and the functional properties demanded by the best professionals, including dimension, volumetry, resistance, and ergonomics.

The global recognition, the frequent collaboration with prestige designers and the bonds created with internationally renowned chefs with which develop its hotelware collections contribute to strengthening the association of Vista Alegre with high gastronomy and ensure its presence in the main hotel groups all over the world making it the leading brand in the hotelware segment in Southern European markets.

UNA MARCA DE EXIGENCIA

El crecimiento progresivo de la oferta y demanda en el sector de la hostelería, y su consiguiente aumento de la calidad, motivaron a Vista Alegre a invertir activamente en este mercado muy competitivo, encarando el turismo como una extensión orgánica de su actividad.

Siempre distintivos, los productos Vista Alegre hotelware ofrecen una inigualable relación calidad/ precio, constituyendo un aumento de competitividad en los segmentos medio, alto y de lujo. Esto se debe a la fuerte imagen de la marca y a una extrema atención prestada a las necesidades del sector, traducida en una diversificada gama de modelos que combinan diseño contemporáneo, innovación técnica y las propiedades funcionales exigidas por los mejores profesionales, entre las cuales se encuentran la dimensión, la volumetría, la resistencia y la ergonomía.

El reconocimiento global, la frecuente colaboración con diseñadores de prestigio y sus lazos con numerosos chefs de renombre internacional con quien se desarrolla las colecciones de hotelware, permiten el fortalecimiento de la asociación de Vista Alegre con la alta gastronomía y asegura la presencia en las principales cadenas de hoteles y restaurantes mundiales, afirmandose como una marca líder en el segmento hotelware en los mercados del sur de Europa.

UNE MARQUE D'EXIGENCE

La croissance progressive de l'offre et de la demande dans le secteur hôtelier, ainsi que l'augmentation conséquente de la qualité a incité Vista Alegre à investir dans ce segment si compétitif, considérant le tourisme comme une extension organique de son activité.

Toujours différenciateurs, les produits dans le segment d'hôtels de Vista Alegre offrent un excellent rapport qualité-prix, constituant un choix attractif dans les segments de moyenne, haute et de luxe. Pour cela, il était associé à l'image forte de la marque une attention extrême aux besoins du secteur, avec une gamme diversifiée alliant le design contemporain, innovation technique et propriétés fonctionnelles, exigées par les meilleurs professionnels, entre lesquelles, la dimension, volumétrie, résistance et ergonomie.

La reconnaissance mondiale, la collaboration fréquente avec des designers prestigieux et les liens créés avec des chefs de renommée internationale, avec lesquels elle développe ses collections d'hôtels, contribuent à renforcer l'association de Vista Alegre avec la haute gastronomie et assurent sa présence dans les principaux groupes hôteliers dans le monde entier, ce qui en fait la marque leader dans le segment des hôtels dans les marchés du sud de l'Europe.



ESSENTIAL





ALGARVE

As paredes caiadas das aldeias algarvias, cuja brancura é intensificada pela incidência do sol, são evocadas no brilho deste modelo, simples e prático, de muito fácil conjugação, constituído por pratos e molheira. A essência da porcelana Vista Alegre.

The whitewashed villages of the Algarve, whose white purity is enhanced by how they catch the sunlight, are evoked in the glow of this model; simple and practical, very easily combined, composed of dishes and gravy boat. The essence of the Vista Alegre porcelain.

Las paredes encaladas de los pueblos de Algarve, cuya blancura se intensifica con la incidencia del sol, son evocadas en el brillo de este modelo, sencillo y práctico, de muy fácil combinación, formado por platos y salsaera. La esencia de la porcelana Vista Alegre.

Les murs blanchis à la chaux des villages de l'Algarve, dont la couleur devient plus intense avec la lumière du soleil, sont évoqués dans la brillance de ce modèle, simple et pratique, très facile à combiner, composé d'assiettes et de saucière. L'essence de la porcelaine Vista Alegre.





ALGARVE 21078114
Prato Raso 26
Dinner Plate 26
Plato Llano 26
Assiette Plate 26
△ 750 gr A 33 mm Ø 261 mm
△ 1 3/8 lbs H 1 3/8" Ø 10 3/8"



ALGARVE 21078133
Prato Raso 24
Dinner Plate 24
Plato Llano 24
Assiette Plate 24
△ 554 gr A 27 mm Ø 239 mm
△ 1 3/8 lbs H 1 1/8" Ø 9 3/8"



ALGARVE 21078151
Prato Sopa 21
Soup Plate 21
Plato Hondo 21
Assiette Creuse 21
△ 415 gr A 37 mm Ø 208 mm CAP. 554 ml
△ 9/16 lbs H 1 1/8" Ø 8 1/8" CAP. 18 3/4 oz



ALGARVE 21126848
Prato Sobremesa 21
Dessert Plate 21
Plato Postre 21
Assiette à Dessert 21
△ 396 gr A 23 mm Ø 211 mm
△ 7/16 lbs H 5/8" Ø 8 3/8"



ALGARVE 21078209
Prato Sobremesa 19
Dessert Plate 19
Plato Postre 19
Assiette à Dessert 19
△ 325 gr A 23 mm Ø 192 mm
△ 5/16 lbs H 5/8" Ø 7 3/8"



ALGARVE 21078177
Prato Pão 15
Bread & Butter Plate 15
Plato Pan 15
Assiette à Pain 15
△ 172 gr A 16 mm Ø 150 mm
△ 3/16 lbs H 5/8" Ø 5 5/8"



ALGARVE 21078246
Molheira com Prato 35 cl
Sauceboat & Stand 35 cl
Salsera con Platillo 35 cl
Saucière avec soucoupe 35 cl
△ 469 gr A 75 mm C 157 mm L 108 mm CAP. 352 ml
△ 1 lbs H 3" L 6 1/8" W 4 1/4" CAP. 11 5/8 oz



BRAGANÇA₅

A brancura da porcelana reforça a sobriedade deste modelo de recorte clássico e a delicada ondulação constitui um elemento de originalidade e encanto. Traços que marcam Portugal e definem a porcelana de referência.

The white gleam of porcelain reinforces the sobriety of this classic-cut out model and the delicate ripple adds a touch of originality and charm. Features that represent Portugal and define porcelain excellence.

La blancura de la porcelana refuerza la sobriedad de este modelo de rasgos clásicos y su delicado ondulado le aporta un elemento de originalidad y encanto. Rasgos que distinguen Portugal y definen la porcelana de referencia.

La blancheur de la porcelaine renforce la sobriété de ce modèle classique et sa délicate ondulation lui donne une touche d'originalité et de charme. Des caractéristiques qui marquent le Portugal et définissent une porcelaine de référence.



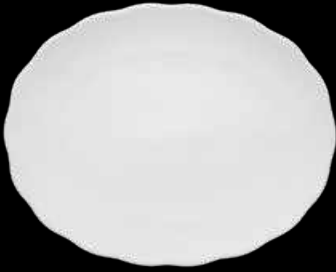

BRAGANÇA 22000060
 Travessa Grande 37
 Large Platter 37
 Fuente Grande 37
 Plat à Servir Grand Modèle 37
 △ 1477 gr A 35 mm C 376 mm L 296 mm
 △ 3 ¼ lbs H 1 ¾" L 14 ½" W 11 ½"



BRAGANÇA 21080624
 Travessa Média 33
 Medium Platter 33
 Fuente Mediana 33
 Plat à Servir Moyen 33
 △ 996 gr A 36 mm C 335 mm L 267 mm
 △ 2 ½ lbs H 1 ¾" L 13 ½" W 10 ½"



BRAGANÇA 22000059
 Travessa Pequena 28
 Small Platter 28
 Fuente Pequeña 28
 Plat à Servir Petit Modèle 28
 △ 725 gr A 28 mm C 289 mm L 227 mm
 △ 1 ¾ lbs H 1 ½" L 11 ¾" W 8 ¾"



BRAGANÇA 22000062
 Prato Marcador 32
 Charger Plate 32
 Plato Presentación 32
 Assiette de Présentation 32
 △ 1248 gr A 23 mm Ø 319 mm
 △ 2 ¾ lbs H ¾" Ø 12 ½"



BRAGANÇA 22000342
 Prato Raso 27
 Dinner Plate 27
 Plato Llano 27
 Assiette Plate 27
 △ 716 gr A 23 mm Ø 266 mm
 △ 1 ½ lbs H ¾" Ø 10 ½"



BRAGANÇA 21080569
 Prato Raso 25
 Dinner Plate 25
 Plato Llano 25
 Assiette Plate 25
 △ 586 gr A 24 mm Ø 248 mm
 △ 1 ¾ lbs H 1" Ø 9 ¾"



BRAGANÇA 22000150
 Prato Sopa 23S
 Soup Plate 23S
 Plato Sopa 23S
 Assiette Creuse 23S
 △ 505 gr A 33 mm Ø 234 mm CAP. 277 ml
 △ 1 ½ lbs H 1 ¾" Ø 9 ¾" CAP. 9 ¾ oz



BRAGANÇA 22000340
 Prato Sobremesa 21
 Dessert Plate 21
 Plato Postre 21
 Assiette à Dessert 21
 △ 338 gr A 17 mm Ø 209 mm
 △ ¾ lbs H ¾" Ø 8 ¾"



BRAGANÇA 22000151
 Prato Sobremesa 19
 Dessert Plate 19
 Plato Postre 19
 Assiette à Dessert 19
 △ 294 gr A 17 mm Ø 189 mm
 △ ¾ lbs H ¾" Ø 7 ¾"



BRAGANÇA 22000152
 Prato Doce 17
 Bread & Butter Plate 17
 Plato Pan 17
 Assiette à Dessert 17
 △ 235 gr A 19 mm Ø 165 mm
 △ ½ lbs H ¾" Ø 6 ½"



BRAGANÇA 21080764
 Prato Manteiga 10
 Butter Plate 10
 Plato Mantequilla 10
 Assiette à Beurre 10
 △ 93 gr A 24 mm Ø 99 mm
 △ ½ lbs H 1" Ø 3 ¾"



BRAGANÇA 22000421
 Prato Salada ½ Lua 21
 Salad Plate ½ Moon 21
 Plato Ensalada ½ Luna 21
 Assiette à Salade ½ Lune 21
 △ 247 gr A 24 mm C 199 mm L 114 mm
 △ ¾ lbs H 1" L 7 ¾" W 4 ½"



BRAGANÇA 22000367
 Conserveira 18
 Olive Dish 18
 Rabanera 18
 Ravier 18
 △ 226 gr A 23 mm C 186 mm L 123 mm
 △ ½ lbs H ¾" L 7 ½" W 4 ¾"



BRAGANÇA 22000061
 Terrina 325cl
 Tureen 325cl
 Sopera 325cl
 Soupière 325cl
 △ 2105 gr A 197 mm C 223 mm L 207 mm CAP. 3249 ml
 △ 4 ¾ lbs H 7 ¾" L 8 ¾" W 8 ½" CAP. 109 ¾ oz



BRAGANÇA 22000063
Saladeira Grande 25
Large Salad Bowl 25
Ensaladera Grande 25
Saladier Grand Modèle 25
△ 1161 gr A 88 mm Ø 247 mm CAP. 2067 ml
△ 2 5/8 lbs H 3 3/8" Ø 9 7/8" CAP. 69 3/8 oz



BRAGANÇA 21080656
Saladeira Média 21
Medium Salad Bowl 21
Ensaladera Mediana 21
Saladier Moyen 21
△ 791 gr A 76 mm Ø 215 mm CAP. 1529 ml
△ 1 3/4 lbs H 3" Ø 8 1/2" CAP. 51 5/8 oz



BRAGANÇA 22000422
Saladeira Pequena 12
Small Salad Bowl 12
Ensaladera Pequeña 12
Saladier Petit Modèle 12
△ 179 gr A 44 mm Ø 123 mm CAP. 288 ml
△ 3/8 lbs H 1 3/4" Ø 4 5/8" CAP. 9 3/4 oz



BRAGANÇA 22000168
Chávena Consomé com Pires 32cl
Consomme Cup & Saucer 32cl
Taza Consomé con Platillo 32cl
Tasse et Soucoupe Bouillon 32cl
△ 432 gr A 58 mm C 168 mm L 113 mm CAP. 323 ml
△ 1 lbs H 2 3/8" L 6 5/8" W 4 3/8" CAP. 10 3/8 oz

BRAGANÇA 22002540
Taça Consomé 32cl
Consomme Cup 32cl
Taza Consomé 32cl
Tasse Bouillon 32cl
△ 206 gr A 58 mm C 153 mm L 113 mm CAP. 323 ml
△ 3/8 lbs H 2 3/8" L 6" W 4 3/8" CAP. 10 3/8 oz



BRAGANÇA 22000406
Molheira com Prato 35cl
Sauceboat & Stand 35cl
Salsera con Platillo 35cl
Saucière avec Soucoupe 35cl

BRAGANÇA 21080693
Molheira 35cl
Sauceboat 35cl
Salsera 35cl
Saucière 35cl
△ 279 gr A 77 mm C 151 mm L 110 mm CAP. 416 ml
△ 5/8 lbs H 3" L 6" W 4 1/8" CAP. 14 1/8 oz



BRAGANÇA 22001448
Tigela Cereais 20
Cereal Bowl 20
Bowl Cereales 20
Bol Céréales 20
△ 431 gr A 42 mm Ø 203 mm CAP. 653 ml
△ 1 lbs H 1 3/8" Ø 8" CAP. 22 1/8 oz



BRAGANÇA 21086638
Leiteira Grande 60cl
Large Milk Jug 60cl
Lechera Grande 60cl
Crémier Grand Modèle 60cl
△ 419 gr A 120 mm C 157 mm L 113 mm CAP. 692 ml
△ 9/16 lbs H 4 5/8" L 6 1/8" W 4 3/8" CAP. 23 3/8 oz



BRAGANÇA 22000057
Leiteira Média 30cl
Medium Milk Jug 30cl
Lechera Mediana 30cl
Crémier Moyen 30cl
△ 259 gr A 98 mm C 121 mm L 89 mm CAP. 330 ml
△ 4/7 lbs H 3 5/8" L 4 3/4" W 3 1/2" CAP. 11 1/8 oz



BRAGANÇA 22003044
Leiteira Pequena 19cl
Small Milk Jug 19cl
Lechera Pequeña 19cl
Crémier Petit Modèle 19cl
△ 161 gr A 81 mm C 101 mm L 74 mm CAP. 190 ml
△ 3/8 lbs H 3 1/8" L 4" W 2 9/8" CAP. 6 3/8 oz



BRAGANÇA 22000174
Açucareiro
Sugar Bowl
Azucarero
Sucrier
△ 252 gr A 106 mm Ø 90 mm CAP. 265 ml
△ 5/8 lbs H 4 1/8" Ø 3 5/8" CAP. 9 oz



BRAGANÇA 22000765
Açucareiro Pacotes
Sugar Box
Azucarero Paquetes
Sucrier Sachets de Sucre
△ 218 gr A 62 mm C 96 mm L 75 mm CAP. 159 ml
△ 1/2 lbs H 2 3/8" L 3 7/8" W 3" CAP. 5 3/8 oz



BRAGANÇA 22000172
Bule Grande 90cl
Large Tea Pot 90cl
Tetera Grande 90cl
Théière Grand Modèle 90cl
△ 751 gr A 142 mm C 190 mm L 135 mm CAP. 877 ml
△ 1 3/8 lbs H 5 3/8" L 7 1/2" W 5 1/8" CAP. 29 3/8 oz



BRAGANÇA 21080840
Bule Pequena 40cl
Small Tea Pot 40cl
Tetera Pequeña 40cl
Théière Petit Modèle 40cl
△ 362 gr A 83 mm C 146 mm L 102 mm CAP. 380 ml
△ 5/8 lbs H 3 1/4" L 5 3/4" W 4" CAP. 12 3/8 oz



BRAGANÇA 22000173
 Cafeteira Grande 80cl
Large Coffee Pot 80cl
 Cafetera Grande 80cl
Cafetière Grand Modèle 80cl
 △ 585 gr A 166 mm C 168 mm L 119 mm CAP. 840 ml
 △ 1 3/8 lbs H 6 5/8" L 6 5/8" W 4 3/8" CAP. 28 3/5 oz



BRAGANÇA 21080887
 Cafeteira Pequena 45cl
Small Coffee Pot 45cl
 Cafetera Pequeña 45cl
Cafetière Petit Modèle 45cl
 △ 356 gr A 140 mm C 143 mm L 98 mm CAP. 470 ml
 △ 7/8 lbs H 5 1/2" L 5 5/8" W 3 5/8" CAP. 15 8/9 oz



BRAGANÇA 22000171
 Châvena Pequeno Almoço com Pires 33cl
Breakfast Cup & Saucer 33cl
 Taza Desayuno con Platillo 33cl
Tasse et Souce-tasse Petit Déjeuner 33cl

BRAGANÇA 21080925
 Châvena Pequeno Almoço 33cl
Breakfast Cup 33cl
 Taza Desayuno 33cl
Tasse Petit Déjeuner 33cl
 △ 217 gr A 58 mm C 134 mm L 114 mm CAP. 329 ml
 △ 1/2 lbs H 2 3/8" L 5 3/8" W 4 1/2" CAP. 11 1/8 oz

BRAGANÇA 21080933
 Pires Consomé/ Pequeno Almoço
Consomme/ Breakfast Saucer
 Platillo Consomé Desayuno
Sous-tasse Bouillon/ Petit Déjeuner
 △ 226 gr A 22 mm Ø 168 mm
 △ 1/2 lbs H 5/8" Ø 6 3/8"



BRAGANÇA 22000170
 Châvena Chá com Pires 24cl
Tea Cup & Saucer 24cl
 Taza Té con Platillo 24cl
Tasse et Sous-tasse Thé 24cl

BRAGANÇA 22001964
 Châvena Chá 24cl
Tea Cup 24cl
 Taza Té 24cl
Tasse Thé 24cl
 △ 185 gr A 57 mm C 120 mm L 99 mm CAP. 239 ml
 △ 3/8 lbs H 2 1/4" L 4 3/8" W 3 3/8" CAP. 8 1/6 oz



BRAGANÇA 22000764
 Châvena Café com Pires 14cl
Coffee Cup & Saucer 14cl
 Taza Café con Platillo 14cl
Tasse et Sous-tasse Café 14cl

BRAGANÇA 21080860
 Châvena Café 14cl
Coffee Cup 14cl
 Taza Café 14cl
Tasse Café 14cl
 △ 119 gr A 52 mm C 97 mm L 79 mm CAP. 140 ml
 △ 1/4 lbs H 2" L 3 3/8" W 3 1/8" CAP. 4 3/4 oz

BRAGANÇA 21080866
 Pires Café 14cl
Coffee Saucer 14cl
 Platillo Café 14cl
Sous-tasse Café 14cl
 △ 117 gr A 18 mm Ø 130 mm
 △ 1/4 lbs H 5/8" Ø 5 1/8"



BRAGANÇA 22000169
 Châvena Café com Pires 10cl
Coffee Cup & Saucer 10cl
 Taza Café con Platillo 10cl
Tasse et Sous-tasse Café 10cl

BRAGANÇA 21080906
 Châvena Café 10cl
Coffee Cup 10cl
 Taza Café 10cl
Tasse Café 10cl
 △ 85 gr A 46 mm C 88 mm L 70 mm CAP. 99 ml
 △ 1/8 lbs H 1 1/2" L 3 3/8" W 2 3/4" CAP. 3 1/3 oz



BRAGANÇA 21080735
 Conjunto Saleiro e Pimenteiro
Salt & Pepper
 Salero y Pimentero
Ensemble Salière et Poivrière

BRAGANÇA 22000425
 Saleiro
Salt
 Salero
Salière
 △ 76 gr A 69 mm Ø 50 mm
 △ 1/6 lbs H 2 3/4" Ø 2"

BRAGANÇA 22000409
 Pimenteiro
Pepper
 Pimentero
Poivrière
 △ 76 gr A 70 mm Ø 50 mm
 △ 1/6 lbs H 2 3/4" Ø 2"



BRAGANÇA 22002544
 Paliteiro
Toothpick Dispenser
 Palitero
Porte Cure-dents
 △ 66 gr A 63 mm Ø 49 mm
 △ 1/8 lbs H 2 1/2" Ø 1 9/8"



BRAGANÇA 21080756
 Oveiro
Egg Cup
 Huevera
Coquetier
 △ 45 gr A 46 mm Ø 50 mm
 △ 1/8 lbs H 1 3/8" Ø 2"



BRAGANÇA 21080678
 Solitário
Flower Vase
 Violetero
Soliflore
 △ 133 gr A 126 mm Ø 65 mm
 △ 3/8 lbs H 5" Ø 2 5/8"



COIMBRA

Numa cidade de estudantes, definida pelo espírito juvenil, a convivialidade afável e despreocupada faz-se sentir um pouco por todo o lado. Espírito esse que transparece na forma deste modelo, aliando à espontaneidade uma grande versatilidade e resistência.

In a city of students, defined by a youthful spirit, affable and unpretentious conviviality is felt just about all over. That spirit shines through in the shapes of this model, which combines spontaneity, versatility and robustness.

En una ciudad de estudiantes, definida por el espíritu juvenil, la convivencia afable y sencilla se siente en todas partes. Dicho espíritu, que se trasluce en la forma de este modelo, junta la espontaneidad a una gran versatilidad y resistencia.

Dans une ville d'étudiants, définie par l'esprit jeune, il existe une convivialité accueillante et sans prétention qui se fait sentir un peu partout. Ce même esprit est révélé par la forme de ce modèle, associant la spontanéité et la résistance à sa polyvalence.





COIMBRA 22000568
 Travessa Grande 41
 Large Platter 41
 Fuente Grande 41
 Plat à Servir Grand Modèle 41
 △1728 gr A 44 mm C 412 mm L 262 mm
 △3 3/8 lbs H 1 3/4" L 16 3/8" W 5/8"



COIMBRA 22000569
 Travessa Média 34
 Medium Platter 34
 Fuente Mediana 34
 Plat à Servir Moyen 34
 △1169 gr A 35 mm C 345 mm L 218 mm
 △2 3/7 lbs H 1 3/8" L 13 3/4" W 5/8"



COIMBRA 22000570
 Travessa Média 28
 Medium Platter 28
 Fuente Mediana 28
 Plat à Servir Moyen 28
 △665 gr A 30 mm C 288 mm L 184 mm
 △1 1/2 lbs H 1 1/8" L 11 1/8" W 4/8"



COIMBRA 22002495
 Travessa Média 25
 Medium Platter 25
 Fuente Mediana 25
 Plat à Servir Moyen 25
 △523 gr A 27 mm C 255 mm L 163 mm
 △1 1/2 lbs H 1 1/8" L 10" W 3/8"



COIMBRA 21074256
 Travessa Pequena 21
 Small Platter 21
 Fuente Pequeña 21
 Plat à Servir Petit Modèle 21
 △308 gr A 22 mm C 216 mm L 140 mm
 △3/8 lbs H 7/8" L 8 1/2" W 1/8"



COIMBRA 21096597
 Prato Raso 28
 Dinner Plate 28
 Plato Llano 28
 Assiette Plate 28
 △931 gr A 27 mm C 287 mm
 △2 lbs H 1 1/8" ∅ 11 3/4"



COIMBRA 21122764
 Prato Raso 26
 Dinner Plate 26
 Plato Llano 26
 Assiette Plate 26
 △683 gr A 24 mm C 265 mm
 △1 1/2 lbs H 1" ∅ 10 3/4"



COIMBRA 22000440
 Prato Raso 24
 Dinner Plate 24
 Plato Llano 24
 Assiette Plate 24
 △585 gr A 30 mm C 247 mm
 △1 3/7 lbs H 1 1/8" ∅ 9 5/8"



COIMBRA 21101375
 Prato Sopa 24
 Soup Plate 24
 Plato Sopa 24
 Assiette Creuse 24
 △641 gr A 41 mm ∅ 240 mm CAP. 375 ml
 △1 3/8 lbs H 1 3/8" ∅ 9 4/8" CAP. 12 3/8 oz



COIMBRA 22000441
 Prato Sopa 21
 Soup Plate 21
 Plato Sopa 21
 Assiette Creuse 21
 △418 gr A 23 mm ∅ 209 mm CAP. 249 ml
 △9/8 lbs H 9/8" ∅ 8 2/8" CAP. 8 3/8 oz



COIMBRA 21101374
 Prato Sobremesa 21
 Dessert Plate 21
 Plato Postre 21
 Assiette à Dessert 21
 △418 gr A 23 mm ∅ 209 mm
 △9/8 lbs H 9/8" ∅ 8 2/8"



COIMBRA 22000442
 Prato Sobremesa 19
 Dessert Plate 19
 Plato Postre 19
 Assiette à Dessert 19
 △318 gr A 24 mm ∅ 190 mm
 △3/7 lbs H 1" ∅ 7 1/2"



COIMBRA 22000561
 Prato Sobremesa 17
 Dessert Plate 17
 Plato Postre 17
 Assiette à Dessert 17
 △269 gr A 24 mm ∅ 174 mm
 △3/8 lbs H 1" ∅ 6 9/8"



COIMBRA 22000560
 Prato Doce 15
 Bread & Butter Plate 15
 Plato Pan 15
 Petit Assiette à Dessert 15
 △199 gr A 20 mm ∅ 149 mm
 △4/8 lbs H 7/8" ∅ 5 7/8"



COIMBRA 21080024
 Prato Manteiga 10
 Butter Plate 10
 Plato Mantequilla 10
 Assiette à Beurre 10
 △116 gr A 22 mm ∅ 104 mm
 △1/4 lbs H 7/8" ∅ 4 1/8"



COIMBRA 21079728
Prato Rectangular 24
Rectangular Plate 24
Plato Rectangular 24
Assiette Rectangulaire 24
△ 872 gr A 30 mm C 245 mm L 198 mm
△ 1 9/16 lbs H 1 1/8" L 9 5/8" W 3/8"



COIMBRA 21079795
Conserveira 17
Olive Dish 17
Rabanera 17
Ravier 17
△ 218 gr A 27 mm C 169 mm L 106 mm
△ 1/2 lbs H 1 1/8" L 6 2/3" W 1/4"



COIMBRA 22000552
Conserveira 14
Olive Dish 14
Rabanera 14
Ravier 14
△ 153 gr A 21 mm C 144 mm L 91 mm
△ 1/3 lbs H 5/8" L 5 3/32" W 3/16"



COIMBRA 21074392
Saladeira Quadrada Grande 24
Large Square Salad Bowl 24
Ensaladera Cuadrada Grande 24
Saladier Carré Grand Modèle 24
△ 1058 gr A 61 mm C 237 mm L 237 mm CAP. 1203 ml
△ 2 1/3 lbs H 2 3/32" L 9 1/32" W 3/8" CAP. 40 2/3 oz



COIMBRA 22000563
Saladeira Quadrada Média 21
Medium Square Salad Bowl 21
Ensaladera Cuadrada Mediana 21
Saladier Carré Moyen 21
△ 803 gr A 60 mm C 213 mm L 212 mm CAP. 861 ml
△ 1 7/8 lbs H 2 3/8" L 8 3/8" W 1/2" CAP. 29 1/2 oz



COIMBRA 21074408
Saladeira Quadrada Média 18
Medium Square Salad Bowl 18
Ensaladera Cuadrada Mediana 18
Saladier Carré Moyen 18
△ 834 gr A 54 mm C 184 mm L 184 mm CAP. 553 ml
△ 1 5/8 lbs H 2 1/8" L 7 1/4" W 3/4" CAP. 18 3/4 oz



COIMBRA 21074419
Saladeira Quadrada 14
Square Salad Bowl 14
Ensaladera Cuadrada 14
Saladier Carré 14
△ 289 gr A 41 mm C 138 mm L 138 mm CAP. 246 ml
△ 2/3 lbs H 1 3/8" L 5 3/8" W 3/8" CAP. 8 1/2 oz



COIMBRA 22000564
Saladeira Quadrada 12
Square Salad Bowl 12
Ensaladera Cuadrada 12
Saladier Carré Modèle 12
△ 289 gr A 38 mm C 122 mm L 122 mm CAP. 169 ml
△ 1/2 lbs H 1 1/2" L 4 1/2" W 1/2" CAP. 5 5/8 oz



COIMBRA 21074498
Chávena Consomé com Pires 30cl
Consomme Cup & Saucer 30cl
Taza Consomé con Platillo 30cl
Tesse et Soucoupe Bouillon 30cl

COIMBRA 21074511
Chávena Consomé 30cl
Consomme Cup 30cl
Taza Consomé 30cl
Tesse Bouillon 30cl
△ 253 gr A 60 mm C 160 mm L 106 mm CAP. 304 ml
△ 5/8 lbs H 2 3/8" L 6 2/8" W 1/4" CAP. 10 2/7 oz



COIMBRA 21075278
Tigela 10
Bowl 10
Bowl 10
Coupe 10
△ 230 gr A 60 mm Ø 106 mm CAP. 305 ml
△ 1/2 lbs H 2 3/8" Ø 4 1/8" CAP. 10 1/3 oz



COIMBRA 22002543
Tigela Frutas 13
Fruit Bowl 13
Taza Fruta 13
Coupe à Fruits 13
△ 194 gr A 37 mm Ø 135 mm CAP. 142 ml
△ 3/7 lbs H 1 1/2" Ø 5 1/2" CAP. 4 4/5 oz



COIMBRA 21080514
Tigela Cereais 17
Cereal Bowl 17
Bowl Cereales 17
Bol Céréales 17
△ 309 gr A 47 mm Ø 174 mm CAP. 316 ml
△ 3/3 lbs H 1 5/8" Ø 6 7/8" CAP. 10 2/3 oz



COIMBRA 22000556
Leiteira Grande 35cl
Large Milk Jug 35cl
Lechera Grande 35cl
Crémier Grand Modèle 35cl
△ 317 gr A 106 mm C 133 mm L 77 mm CAP. 332 ml
△ 3/7 lbs H 4 1/8" L 5 1/4" W 1/2" CAP. 11 2/5 oz



COIMBRA 21075031
Leiteira Pequena 20cl
Small Milk Jug 20cl
Lechera Pequena 20cl
Crémier Petit Modèle 20cl
△ 206 gr A 92 mm C 113 mm L 67 mm CAP. 205 ml
△ 3/6 lbs H 3 3/8" L 4 4/8" W 1/6" CAP. 6 8/9 oz



COIMBRA 22000548
Açucareiro
Sugar Bowl
Azucarero
Sucrier
△ 282 gr A 80 mm Ø 89 mm CAP. 254 ml
△ 5/8 lbs H 3 1/2" Ø 3 1/2" CAP. 8 3/5 oz



COIMBRA 22000549
Bule Grande 80cl
Large Tea Pot 80cl
Tetera Grande 80cl
Théière Grand Modèle 80cl
△ 735 gr A 120 mm C 201 mm L 128 mm CAP. 830 ml
△ 1 5/8 lbs H 4 5/8" L 7 8/9" W 1/3" CAP. 28 1/2 oz



COIMBRA 21074856
Bule Pequeno 40cl
Small Tea Pot 40cl
Tetera Pequeña 40cl
Théière Petit Modèle 40cl
△ 427 gr A 91 mm C 157 mm L 101 mm CAP. 355 ml
△ 8/9 lbs H 3 4/8" L 6 1/8" W 1/4" CAP. 12 oz



COIMBRA 22000550
Cafeteira Grande 60cl
Large Coffee Pot 60cl
Cafetera Grande 60cl
Cafetière Grand Modèle 60cl
△ 642 gr A 145 mm C 170 mm L 90 mm CAP. 633 ml
△ 1 3/8 lbs H 5 5/8" L 6 5/8" W 1/4" CAP. 21 2/5 oz



COIMBRA 21075189
Cafeteira Pequena 30cl
Small Coffee Pot 30cl
Cafetera Pequeña 30cl
Cafetière Petit Modèle 30cl
△ 339 gr A 121 mm C 137 mm L 78 mm CAP. 328 ml
△ 3/4 lbs H 4 3/4" L 5 3/8" W 2/8" CAP. 11 1/2 oz



COIMBRA 21075234
Chávena Pequeno Almoço com Pires 30cl
Breakfast Cup & Saucer 30cl
Taza Desayuno con Platillo 30cl
Tasse et Sous-tasse Petit Déjeuner 30cl

COIMBRA 21075248
Chávena Pequeno Almoço 30cl
Breakfast Cup 30cl
Taza Desayuno 30cl
Tasse Petit Déjeuner 30cl
△ 252 gr A 60 mm C 132 mm L 106 mm CAP. 295 ml
△ 5/8 lbs H 2 3/8" L 5 1/8" W 1/8" CAP. 10 oz



COIMBRA 21074614
Chávena Chá 20cl
Tea Cup 20cl
Taza Té 20cl
Tasse Thé 20cl
△ 182 gr A 53 mm C 118 mm L 92 mm CAP. 202 ml
△ 3/8 lbs H 2 1/8" L 4 3/8" W 1/8" CAP. 6 5/8 oz

COIMBRA 21077817
Pires Pequeno Almoço 30cl
Breakfast Saucer 30cl
Platillo Desayuno 30cl
Sous-tasse Petit Déjeuner 30cl
△ 239 gr A 26 mm ∅ 161 mm
△ 1/2 lbs H 1" L 5 5/8" ∅ 6 1/8"

COIMBRA 21074595
Chávena Chá com Pires 20cl
Tea Cup & Saucer 20cl
Taza Té con Platillo 20cl
Tasse et Sous-tasse Thé 20cl

COIMBRA 21076276
Pires Chá 20cl
Tea Saucer 20cl
Platillo Té 20cl
Sous-tasse Thé 20cl
△ 234 gr A 24 mm ∅ 149 mm
△ 1/2 lbs H 1" L 5 5/8" ∅ 5 7/8"



COIMBRA 21080257
Chávena Chá 18cl
Tea Cup 18cl
Taza Té 18cl
Tasse Thé 18cl
△ 224 gr A 76 mm C 102 mm L 80 mm CAP. 177 ml
△ 1/2 lbs H 3" L 4" W 1/8" CAP. 6 oz



COIMBRA 21080347
Chávena Espresso 6cl
Espresso Cup 6cl
Taza Espresso 6cl
Tasse Espresso 6cl
△ 155 gr A 58 mm C 86 mm L 66 mm CAP. 58 ml
△ 1/3 lbs H 2 2/8" L 3 3/8" W 1/8" CAP. 2 oz

COIMBRA 21080264
Pires Chá 18cl
Tea Saucer 18cl
Platillo Té 18cl
Sous-tasse Thé 18cl
△ 216 gr A 20 mm ∅ 144 mm
△ 1/2 lbs H 7/8" L 5 5/8" ∅ 5 3/8"

COIMBRA 21080345
Chávena Café Espresso com Pires 9cl
Espresso Cup & Saucer 9cl
Taza Espresso con Platillo 9cl
Tasse et Sous-tasse Espresso 9cl

COIMBRA 21080359
Pires Espresso 6cl
Espresso Saucer 6cl
Platillo Espresso 6cl
Sous-tasse Espresso 6cl
△ 166 gr A 19 mm ∅ 125 mm
△ 3/8 lbs H 3/4" L 5 5/8" ∅ 4 3/8"



COIMBRA 21075067
Chávena Café com Pires 11cl
Coffee Cup & Saucer 11cl
Taza Café con Platillo 11cl
Tasse et Sous-tasse Café 11cl

COIMBRA 21075084
Chávena Café 11cl
Coffee Cup 11cl
Taza Café 11cl
Tasse Café 11cl
△ 101 gr A 45 mm C 97 mm L 76 mm CAP. 112 ml
△ 2/8 lbs H 1 7/8" L 3 3/8" W 1/8" CAP. 3 7/8 oz



COIMBRA 21080424
Chávena Moka 7cl
Moka Cup 7cl
Taza Moka 7cl
Tasse Moka 7cl
△ 114 gr A 53 mm C 76 mm L 55 mm CAP. 70 ml
△ 1/4 lbs H 2 1/8" L 3" W 1/8" CAP. 2 3/8 oz

COIMBRA 21077296
Pires Café 11cl
Coffee Saucer 11cl
Platillo Café 11cl
Sous-tasse Café 11cl
△ 144 gr A 20 mm ∅ 121 mm
△ 1/3 lbs H 7/8" L 5 5/8" ∅ 4 3/8"

COIMBRA 22000575
Chávena Café Moka com Pires 7cl
Moka Cup & Saucer 7cl
Taza Moka con Platillo 7cl
Tasse et Sous-tasse Moka 7cl

COIMBRA 21077296
Pires Moka 7cl
Moka Saucer 7cl
Platillo Moka 7cl
Sous-tasse Moka 7cl
△ 144 gr A 20 mm ∅ 121 mm
△ 1/3 lbs H 7/8" L 5 5/8" ∅ 4 3/8"



COIMBRA 22000557
 Molheira 10cl
Sauceboat 10cl
Salsera 10cl
Saucière 10cl
 △ 132 gr A 48mm C 132mm L 65 mm CAP. 109 ml
 △ 3/7 lbs H 1 3/8" L 5 1/8" W 1/2" CAP. 3 2/3 oz



COIMBRA 21074656
 Chávena sem Asa 11cl
Cup without Handle 11cl
Taza sin Asa 11cl
Tasse sans Anse 11cl
 △ 100 gr A 45 mm Ø 75 mm CAP. 110 ml
 △ 3/6 lbs H 1 1/8" Ø 3" CAP. 3 2/7 oz



COIMBRA 22000565
 Saleiro
Salt
Salero
Salière
 △ 45 gr A 62 mm Ø 38 mm
 △ 1 1/10 lbs H 2 1/8" Ø 1 1/2"



COIMBRA 22000559
 Pimenteiro
Pepper
Pimentero
Poivrière
 △ 45 gr A 62 mm Ø 38 mm
 △ 1 1/10 lbs H 2 1/8" Ø 1 1/2"



COIMBRA 22000932
 Oveiro
Egg Cup
Huevera
Coquetier
 △ 74 gr A 53 mm Ø 50 mm
 △ 1/6 lbs H 2 1/8" Ø 2"



COIMBRA 22000558
 Paliteiro
Toothpick Dispenser
Palillero
Porte Cure-dents
 △ 100 gr A 105 mm Ø 50 mm
 △ 3/6 lbs H 4 1/8" Ø 2"



COIMBRA 22000555
 Jarro Grande
Large Jug
Jarro Grande
Pichet Grand Modèle
 △ 850 gr A 193 mm C 157 mm L 83 mm CAP. 1181 ml
 △ 1 7/8 lbs H 7 3/8" L 6 1/8" W 1/4" CAP. 39 9/16 oz



COIMBRA 22000554
 Jarro Pequeno
Small Jug
Jarro Pequeno
Pichet Petit Modèle
 △ 387 gr A 143 mm C 116 mm L 59 mm CAP. 418 ml
 △ 3/6 lbs H 5 5/8" L 4 1/4" W 1/6" CAP. 14 1/2 oz



COIMBRA 22000551
 Cinzeiro
Ashtray
Cenicero
Cendrier
 △ 159 gr A 26 mm Ø 124 mm
 △ 1/3 lbs H 1" Ø 4 7/8"



COIMBRA 21080151
 Cinzeiro Água
Water Ashtray
Cenicero Agua
Cendrier à Eau
 △ 420 gr A 71 mm Ø 108 mm CAP. 290 ml
 △ 9/8 lbs H 2 1/8" Ø 4 1/4" CAP. 9 1/2"



COIMBRA 22000553
 Jarra
Flower Vase
Violetero
Vase
 △ 222 gr A 125 mm Ø 78 mm
 △ 1/2 lbs H 4 3/8" Ø 3 1/8"





ESCORIAL

Inspirado no complexo histórico mandado erigir por Filipe II de Espanha no século XVI, Escorial revela a polivalência artística e a mestria técnica da Vista Alegre. Neste conjunto clássico de grande requinte sobressai uma textura incomparável, criada por delicados relevos.

Inspired by the historic complex erected by Philip II of Spain in the sixteenth century, the Escorial reveals all of Vista Alegre's artistic versatility and technical mastery. This classic set of great refinement stands out for its unmatched texture, created by delicate reliefs.

Inspirado en El Escorial, el conjunto histórico que mandó construir Felipe II de España en el siglo XVI, revela la polivalencia artística y la maestría técnica de Vista Alegre. En este conjunto clásico de gran refinamiento destaca una textura incomparable, creada por delicados relieves.

S'inspirant du complexe historique érigé sous les ordres du roi Philippe II d'Espagne au XVIe siècle, Escorial révèle la polyvalence artistique et la maîtrise technique de Vista Alegre. Cet ensemble classique d'un grand raffinement fait ressortir sa texture sans égal, créée par des reliefs délicats.





ESCORIAL 22000138
Travessa Oval Grande 33
Large Oval Platter 33
Fuente Oval Grande 33
Plat à Servir Ovale Grand Modèle 33
△ 977 gr A 36 mm C 335 mm L 266 mm
△ 2 1/4 lbs H 1 3/8" L 13 1/2" W 10 1/2"



ESCORIAL 22000139
Travessa Oval Média 29
Medium Oval Platter 29
Fuente Oval Mediana 29
Plat à Servir Ovale Moyen 29
△ 721 gr A 29 mm C 291 mm L 231 mm
△ 1 3/8 lbs H 1 1/8" L 11 1/2" W 9 1/8"



ESCORIAL 22000142
Prato Marcador 32
Charger Plate 32
Plato Presentación 32
Assiette de Présentation 32
△ 1203 gr A 25 mm Ø 320 mm
△ 2 2/3 lbs H 1" Ø 12 3/4"



ESCORIAL 21094109
Prato Raso 29,5
Dinner Plate 29,5
Plato Llano 29,5
Assiette Plate 29,5
△ 1026 gr A 26 mm Ø 295 mm
△ 2 1/4 lbs H 1" Ø 11 5/8"



ESCORIAL 22000175
Prato Raso 27
Dinner Plate 27
Plato Llano 27
Assiette Plate 27
△ 692 gr A 24 mm Ø 265 mm
△ 1 1/2 lbs H 1" Ø 10 3/4"



ESCORIAL 22000453
Prato Raso 25
Dinner Plate 25
Plato Llano 25
Assiette Plate 25
△ 597 gr A 22 mm Ø 248 mm
△ 1 1/3 lbs H 7/8" Ø 9 3/4"



ESCORIAL 22000095
Prato Sopa 23
Soup Plate 23
Plato Sopa 23
Assiette Creuse 23
△ 525 gr A 34 mm Ø 234 mm CAP. 258 ml
△ 1 1/4 lbs H 1 1/8" Ø 9 3/8" CAP. 8 3/4 oz



ESCORIAL 22000096
Prato Sobremesa 21
Dessert Plate 21
Plato Postre 21
Assiette à Dessert 21
△ 356 gr A 17 mm Ø 210 mm
△ 7/8 lbs H 3/8" Ø 8 1/4"



ESCORIAL 22000137
Prato Sobremesa 19
Dessert Plate 19
Plato Postre 19
Assiette à Dessert 19
△ 291 gr A 17 mm Ø 190 mm
△ 5/8 lbs H 3/8" Ø 7 1/2"



ESCORIAL 22000452
Prato Pão 17
Bread & Butter Plate 17
Plato Pan 17
Assiette à Pain 17
△ 245 gr A 20 mm Ø 165 mm
△ 5/8 lbs H 7/8" Ø 6 1/2"



ESCORIAL 22000140
Saladeira Grande 21
Large Salad Bowl 21
Ensaladera Grande 21
Saladier Grand Modèle 21
△ 689 gr A 71 mm Ø 211 mm CAP. 1303 ml
△ 1 1/2 lbs H 2 4/8" Ø 8 3/8" CAP. 44 1/2 oz



ESCORIAL 21078333
Saladeira Pequena 13
Small Salad Bowl 13
Ensaladera Pequeña 13
Saladier Petit Modèle 13
△ 236 gr A 49 mm Ø 136 mm CAP. 362 ml
△ 1/2 lbs H 1 8/8" Ø 5 3/8" CAP. 12 1/4 oz



ESCORIAL 22000450
Chávena Consomé com Pires 26cl
Consomme Cup & Saucer 26cl
Taza Consomé con Platillo 26cl
Tasse et Soucoupe Bouillon 26cl

ESCORIAL 21078350
Chávena Consomé 26cl
Consomme Cup 26cl
Taza Consomé 26cl
Tasse Bouillon 26cl
△ 272 gr A 55 mm C 145 mm L 102 mm CAP. 269 ml
△ 3/5 lbs H 2 1/8" L 5 7/8" W 4" CAP. 9 1/5 oz



ESCORIAL 21078341
Molheira 50cl
Sauceboat 50cl
Salsera 50cl
Saucière 50cl
△ 435 gr A 100 mm C 246 mm L 93 mm CAP. 493 ml
△ 1 lbs H 3 3/8" L 9 7/8" W 3 3/8" CAP. 16 2/5 oz

ESCORIAL 21078482
Pires Consomé 26cl
Consomme Saucer 26cl
Platillo Consomé 26cl
Soucoupe Bouillon 26cl
△ 288 gr A 23 mm Ø 168 mm
△ 3/8 lbs H 3/8" Ø 6 5/8"

ESCORIAL 22000141
Molheira com Prato 50cl
Sauceboat 50cl
Salsera con Platillo 50cl
Saucière Soucoupe 50cl

ESCORIAL 21078344
Prato Molheira 50cl
Stand Sauceboat 50cl
Platillo Salsera 50cl
Soucoupe Saucière 50cl
△ 235 gr A 19 mm C 196 mm L 124 mm CAP. 190 ml
△ 1/2 lbs H 3/4" L 7 3/4" W 4 7/8" CAP. 6 3/4 oz



ESCORIAL 22000455
Tigela 12
Bowl 12
Bowl 12
Coupe 12
△ 318 gr A 60 mm Ø 112 mm CAP. 343 ml
△ 3/7 lbs H 2 1/8" Ø 4 2/8" CAP. 11 3/5 oz



ESCORIAL 21078491
Tigela Cereais 16
Cereal Bowl 16
Bowl Cereales 16
Bol Céréales 16
△ 308 gr A 45 mm Ø 169 mm CAP. 288 ml
△ 3/5 lbs H 1 7/8" Ø 6 3/8" CAP. 9 3/4 oz



ESCORIAL 21078496
Tigela Frutas 13
Fruit Bowl 13
Bowl Frutas 13
Bol à Fruits 13
△ 219 gr A 40 mm Ø 135 mm CAP. 146 ml
△ 1/2 lbs H 1 1/2" Ø 5 1/8" CAP. 4 9/8 oz



ESCORIAL 22000451
Leiteira 30cl
Milk Jug 30cl
Lechera 30cl
Crémier 30cl
△ 228 gr A 102 mm C 119 mm L 62 mm CAP. 325 ml
△ 1/2 lbs H 4" L 4 2/8" W 2 3/8" CAP. 11 oz



ESCORIAL 22000430
Bule Grande 80cl
Large Tea Pot 80cl
Tetera Grande 80cl
Théière Grand Modèle 80cl
△ 579 gr A 146 mm C 118 mm L 60 mm CAP. 964 ml
△ 1 2/7 lbs H 5 3/4" L 4 2/8" W 2 3/8" CAP. 32 3/5 oz



ESCORIAL 21078414
Bule Pequeno 40cl
Small Tea Pot 40cl
Tetera Pequeña 40cl
Théière Petit Modèle 40cl
△ 328 gr A 144 mm C 134 mm L 94 mm CAP. 370 ml
△ 3/7 lbs H 5 2/8" L 5 2/8" W 3 3/8" CAP. 12 1/2 oz



ESCORIAL 22000431
Cafeteira Grande 80cl
Large Coffee Pot 80cl
Cafetera Grande 80cl
Cafetière Grand Modèle 80cl
△ 579 gr A 146 mm C 118 mm L 66 mm CAP. 260 ml
△ 1 2/7 lbs H 5 3/4" L 4 2/8" W 2 3/8" CAP. 8 4/5 oz



ESCORIAL 21078444
Cafeteira Pequena 40cl
Small Coffee Pot 40cl
Cafetera Pequeña 40cl
Cafetière Petit Modèle 40cl
△ 328 gr A 144 mm C 134 mm L 94 mm CAP. 370 ml
△ 3/7 lbs H 5 2/8" L 5 2/8" W 3 3/8" CAP. 12 1/2 oz



ESCORIAL 22000429
Açucareiro
Sugar Bowl
Azucarero
Sucrier
△ 240 gr A 112 mm C 118 mm L 66 mm CAP. 260 ml
△ 3/8 lbs H 4 2/8" L 4 2/8" W 2 3/8" CAP. 8 4/5 oz



ESCORIAL 22000434
Chávena Pequeno Almoço com Pires 27cl
Breakfast Cup & Saucer 27cl
Taza Desayuno con Platillo 27cl
Tasse et Sous-tasse Petit Déjeuner 27cl

ESCORIAL 21078477
Chávena Pequeno Almoço 27cl
Breakfast Cup 27cl
Taza Desayuno 27cl
Tasse Petit Déjeuner 27cl
△ 270 gr A 67 mm C 116 mm L 90 mm CAP. 269 ml
△ 3/5 lbs H 2 3/8" L 4 1/4" W 3 5/8" CAP. 9 1/8 oz



ESCORIAL 21078372
Chávena Chá 17cl
Tea Cup 17cl
Taza Té 17cl
Tasse Thé 17cl
△ 210 gr A 58 mm C 105 mm L 80 mm CAP. 170 ml
△ 4/9 lbs H 2 3/8" L 4 1/8" W 3 1/8" CAP. 5 3/4 oz

ESCORIAL 22000433
Chávena Chá com Pires 17cl
Tea Cup & Saucer 17cl
Taza Té con Platillo 17cl
Tasse et Sous-tasse Thé 17cl

ESCORIAL 21078379
Pires Chá 17cl
Tea Saucer 17cl
Platillo Té 17cl
Sous-tasse Thé 17cl
△ 178 gr A 21 mm Ø 145 mm
△ 3/5 lbs H 3/8" Ø 5 5/8"



ESCORIAL 21078388
Chávena Chá 20cl
Tea Cup 20cl
Taza Té 20cl
Tasse Thé 20cl
△ 226 gr A 63 mm C 108 mm Ø 83 mm CAP. 203 ml
△ 1/2 lbs H 2 1/2" L 4 1/4" Ø 3 1/4" CAP. 6 3/4 oz



ESCORIAL 21078379
Pires Chá 20cl
Tea Saucer 20cl
Platillo Té 20cl
Sous-tasse Thé 20cl
△ 178 gr A 21 mm Ø 145 mm
△ 3/5 lbs H 3/8" Ø 5 5/8"

ESCORIAL 21078426
Chávena Café 11cl
Coffee Cup 11cl
Taza Café 11cl
Tasse Café 11cl
△ 133 gr A 58 mm C 91 mm L 66 mm CAP. 123 ml
△ 2/7 lbs H 2 3/8" L 3 3/8" W 2 3/8" CAP. 4 1/8 oz

ESCORIAL 21078468
Pires Café 11cl
Coffee Saucer 11cl
Platillo Café 11cl
Sous-tasse Café 11cl
△ 112 gr A 20 mm Ø 122 mm
△ 1/4 lbs H 7/8" Ø 4 3/8"



ESCORIAL 22000432
Chávena Café com Pires 10cl
Coffee Cup & Saucer 10cl
Taza Café con Platillo 10cl
Tasse et Sous-tasse Café 10cl

ESCORIAL 21078462
Chávena Café 10cl
Coffee Cup 10cl
Taza Café 10cl
Tasse Café 10cl
△ 113 gr A 49 mm C 87 mm L 66 mm CAP. 98 ml
△ 1/4 lbs H 1 3/8" L 3 3/8" W 2 3/8" CAP. 3 1/2 oz



ESCORIAL 21078356
Saleiro
Salt
Salero
Salière
△ 60 gr A 73 mm Ø 42 mm
△ 1/8 lbs H 2 7/8" Ø 1 3/8"



ESCORIAL 21078359
Pimenteiro
Pepper
Pimentero
Poivrière
△ 60 gr A 73 mm Ø 42 mm
△ 1/8 lbs H 2 7/8" Ø 1 3/8"

ESCORIAL 21078468
Pires Café 10cl
Coffee Saucer 10cl
Platillo Café 10cl
Sous-tasse Café 10cl
△ 112 gr A 20 mm Ø 122 mm
△ 1/4 lbs H 7/8" Ø 4 3/8"



ESCORIAL 21078362
Oveiro
Egg Cup
Huevera
Coquetier
△ 57 gr A 56 mm Ø 48 mm
△ 1/8 lbs H 2 1/8" Ø 1 3/8"



ESCORIAL 21078365
Cinzeiro
Ashtray
Cenicero
Cendrier
△ 98 gr A 24 mm Ø 95 mm
△ 3/8 lbs H 1" Ø 3 3/8"



ESTORIL

Estoril é um dos modelos mais clássicos da gama de hotelaria da Vista Alegre. Desenvolvido especificamente para o uso diário em restaurantes e hotéis, converteu-se num favorito entre os profissionais de restauração graças ao seu bonito design, excelente resistência, bom empilhamento e uma gama abrangente de 50 itens.

The Estoril is one of the more classic models of the Vista Alegre hotel line. Specifically developed for everyday use in restaurants and hotels, it has become a favourite among catering professionals, thanks to its beautiful design, outstanding robustness, good stackability and a comprehensive range, composed of 50 pieces.

Estoril es uno de los modelos más clásicos de la gama de hostelería de Vista Alegre. Desarrollado específicamente para el uso diario en restaurantes y hoteles, se convirtió en uno de los favoritos entre los profesionales de la restauración gracias a su bonito diseño, excelente resistencia, buen apilamiento y una amplia gama de 50 piezas.

Estoril est l'un des modèles plus classiques d'hôtellerie de Vista Alegre. Développé spécifiquement pour une utilisation quotidienne dans les restaurants et hôtels, ce service est devenu le favori des professionnels de la restauration grâce à son beau design, une excellente résistance, un bon empilage et une gamme complète de 50 articles.



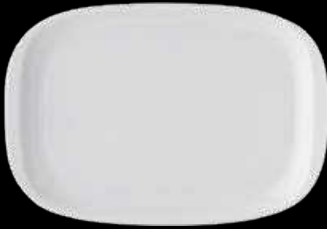

ESTORIL 22002511
Travessa Oval Grande 37
Large Oval Platter 37
Fuente Oval Grande 37
Plat à Servir Ovale Grand Modèle 37
△1361 gr A 30 mm C 375 mm L 254 mm
△3 lbs H 1 1/8" L 14 3/4" W 10"



ESTORIL 21075538
Travessa Oval Média 33
Medium Oval Platter 33
Fuente Oval Mediana 33
Plat à Servir Ovale Moyen 33
△1007 gr A 29 mm C 331 mm L 228 mm
△2 3/8 lbs H 1 1/2" L 13" W 9"



ESTORIL 21075593
Travessa Oval Média 29
Medium Oval Platter 29
Fuente Oval Mediana 29
Plat à Servir Ovale Moyen 29
△764 gr A 26 mm C 298 mm L 204 mm
△1 7/8 lbs H 1" L 11 3/4" W 8"



ESTORIL 21075657
Travessa Oval Pequena 25
Small Oval Platter 25
Fuente Oval Pequeña 25
Plat à Servir Ovale Petit Modèle 25
△460 gr A 25 mm C 264 mm L 175 mm
△1 lbs H 1" L 10 5/8" W 6 7/8"



ESTORIL 21079650
Prato Marcador 32
Charger Plate 32
Plato Presentación 32
Assiette de Présentation 32
△1179 gr A 24 mm Ø 319 mm
△2 3/8 lbs H 1" Ø 12 5/8"

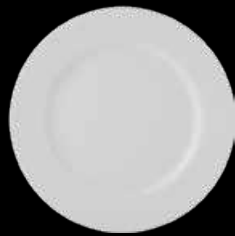

ESTORIL 21090219
Prato Raso 29
Dinner Plate 29
Plato Llano 29
Assiette Plate 29
△965 gr A 24 mm Ø 296 mm
△2 1/8 lbs H 1" Ø 11 3/8"



ESTORIL 22002524
Prato Raso 27
Dinner Plate 27
Plato Llano 27
Assiette Plate 27
△734 gr A 23 mm Ø 269 mm
△1 5/8 lbs H 3/8" Ø 10 3/8"



ESTORIL 22002507
Prato Raso 25
Dinner Plate 25
Plato Llano 25
Assiette Plate 25
△621 gr A 24 mm Ø 248 mm
△1 3/8 lbs H 1" Ø 9 3/4"



ESTORIL 22002525
Prato Sopa 23
Soup Plate 23
Plato Hondo 23
Assiette Creuse 23
△488 gr A 31 mm Ø 234 mm CAP. 388 ml
△1 1/8 lbs H 1 3/8" Ø 9 3/8" CAP. 13 1/8 oz



ESTORIL 22002526
Prato Sobremesa 21
Dessert Plate 21
Plato Postre 21
Assiette à Dessert 21
△367 gr A 16 mm Ø 210 mm
△8 1/8 lbs H 5/8" Ø 8 1/4"



ESTORIL 21078924
Prato Sobremesa 19
Dessert Plate 19
Plato Postre 19
Assiette à Dessert 19
△306 gr A 17 mm Ø 190 mm
△7 3/8 lbs H 3/8" Ø 7 1/2"



ESTORIL 22002527
Prato Pão 17
Bread & Butter Plate 17
Plato Pan 17
Assiette à Pain 17
△231 gr A 19 mm Ø 166 mm
△1/2 lbs H 3/4" Ø 6 3/4"



ESTORIL 21080024
Prato Manteiga 13
Butter Plate 13
Plato Mantequilla 13
Assiette à Beurre 13
△120 gr A 21 mm Ø 130 mm
△1/4 lbs H 5/8" Ø 5 1/8"



ESTORIL 22000562
Prato Salada 1/2 Lua
Salad Plate 1/2 Moon
Ensaladera 1/2 Luna
Assiette à Salade 1/2 Luna
△311 gr A 21 mm C 215 mm L 109 mm
△7 3/8 lbs H 5/8" L 8 3/8" W 4 3/8"



ESTORIL 21079795
Conserveira Grande
Large Olive Dish
Rabanera Grande
Ravier Grand Modèle
△217 gr A 27 mm C 170 mm L 104 mm
△1/2 lbs H 1 1/8" L 6 5/8" W 4 1/8"



ESTORIL 22000552
Conserveira Pequena
Small Olive Dish
Rabanera Pequena
Ravier Petit Modèle
△145 gr A 20 mm C 142 mm L 90 mm
△1/3 lbs H 3/4" L 5 3/8" W 3 5/8"



ESTORIL 22000566

Terrina 267cl
Tureen 267cl
Sopera 267cl
Soupière 267cl

△ 1232 gr A 106 mm Ø 219 mm CAP. 2800 ml
△ 2 7/8 lbs H 4 1/8" Ø 8 5/8" CAP. 94 2/3 oz



ESTORIL 21075773

Saladeira Grande 23
Large Salad Bowl 23
Ensaladera Grande 23
Saladier Grand Modèle 23

△ 1040 gr A 74 mm Ø 232 mm CAP. 2143 ml
△ 2 2/8 lbs H 2 8/8" Ø 9 1/8" CAP. 72 4/8 oz



ESTORIL 21075852

Saladeira Média 19
Medium Salad Bowl 19
Ensaladera Mediana 19
Saladier Moyen 19

△ 707 gr A 62 mm Ø 190 mm CAP. 1111 ml
△ 1 5/8 lbs H 2 4/8" Ø 7 1/2" CAP. 37 4/8 oz



ESTORIL 21075906

Saladeira Pequena 16
Small Salad Bowl 16
Ensaladera Pequeña 16
Saladier Petit Modèle 16

△ 433 gr A 55 mm Ø 161 mm CAP. 704 ml
△ 1 lbs H 2 1/8" Ø 6 1/8" CAP. 23 4/8 oz



ESTORIL 21078978

Châvena Consomé com Pires 26cl
Consomme Cup & Saucer 26cl
Taza Consomé con Platico 26cl
Tasse et Soucoupe Bouillon 26cl

△ 250 gr A 55 mm C 141 mm L 100 mm CAP. 264 ml
△ 3/8 lbs H 2 1/8" L 5 5/8" W 3 3/8" CAP. 8 3/8 oz

ESTORIL 21079017

Châvena Consomé 26cl
Consomme Cup 26cl
Taza Consomé 26cl
Tasse Bouillon 26cl

△ 250 gr A 55 mm C 141 mm L 100 mm CAP. 264 ml
△ 3/8 lbs H 2 1/8" L 5 5/8" W 3 3/8" CAP. 8 3/8 oz



ESTORIL 21077817

Pires Consomé 26cl
Consomme Saucer 26cl
Platico Consomé 26cl
Soucoupe Bouillon 26cl

△ 226 gr A 27 mm Ø 161 mm
△ 1/2 lbs H 1 1/8" Ø 6 1/8"

ESTORIL 21078246

Molheira com Prato 35cl
Sauceboat & Stand 35cl
Salsera con Platico 35cl
Saucière avec Soucoupe 35cl

△ 608 gr A 75 mm Ø 152 mm CAP. 300 ml
△ 1 1/8 lbs H 3" Ø 6" CAP. 10 1/2 oz



ESTORIL 22000567

Tigela Grande 12
Large Bowl 12
Bowl Grande 12
Coupe Grand Modèle 12

△ 303 gr A 63 mm Ø 122 mm CAP. 463 ml
△ 3/8 lbs H 2 1/8" Ø 4 3/8" CAP. 15 3/8 oz



ESTORIL 21078078

Tigela Pequena 10
Small Bowl 10
Bowl Pequeña 10
Coupe Petit Modèle 10

△ 268 gr A 58 mm Ø 100 mm CAP. 282 ml
△ 3/8 lbs H 2 3/8" Ø 3 3/8" CAP. 9 3/8 oz



ESTORIL 21077089

Leiteira Grande 30cl
Large Milk Jug 30cl
Lechera Grande 30cl
Crémier Grand Modèle 30cl

△ 304 gr A 83 mm C 123 mm L 83 mm CAP. 280 ml
△ 3/8 lbs H 3 1/4" L 4 5/8" W 3 1/4" CAP. 9 4/8 oz



ESTORIL 21077145

Leiteira Pequena 15cl
Small Milk Jug 15cl
Lechera Pequeña 15cl
Crémier Petit Modèle 15cl

△ 199 gr A 67 mm C 106 mm L 72 mm CAP. 166 ml
△ 4/8 lbs H 2 5/8" L 4 1/8" W 2 5/8" CAP. 5 5/8 oz



ESTORIL 21076484

Açucareiro
Sugar Bowl
Azucarero
Sucrier

△ 318 gr A 61 mm Ø 96 mm CAP. 260 ml
△ 3/8 lbs H 2 3/8" Ø 3 7/8" CAP. 8 4/8 oz



ESTORIL 21076701

Bule Grande 65cl
Large Tea Pot 65cl
Tetera Grande 65cl
Théière Grand Modèle 65cl

△ 768 gr A 107 mm C 175 mm L 128 mm CAP. 666 ml
△ 1 5/8 lbs H 4 3/8" L 6 8/8" W 5" CAP. 22 1/2 oz



ESTORIL 21076897

Bule Pequeno 35cl
Small Tea Pot 35cl
Tetera Pequeña 35cl
Théière Petit Modèle 35cl

△ 477 gr A 92 mm C 145 mm L 104 mm CAP. 381 ml
△ 1 lbs H 3 5/8" L 5 5/8" W 4 1/8" CAP. 12 3/8 oz



ESTORIL 21077499

Cafeteira Grande 60cl
Large Coffee Pot 60cl
Cafetera Grande 60cl
Cafetière Grand Modèle 60cl

△ 684 gr A 128 mm C 153 mm L 103 mm CAP. 556 ml
△ 1 1/2 lbs H 5" L 6" W 4" CAP. 18 4/8 oz



ESTORIL 21077624

Cafeteira Pequena 30cl
Small Coffee Pot 30cl
Cafetera Pequeña 30cl
Cafetière Petit Modèle 30cl

△ 365 gr A 99 mm C 127 mm L 87 mm CAP. 325 ml
△ 4/8 lbs H 3 3/8" L 5" W 3 3/8" CAP. 11 oz



ESTORIL 21079500
Chávena Pequeno Almoço com Pires 27cl
Breakfast Cup & Saucer 27cl
Taza Desayuno con Platillo 27cl
Tasse et Sous-tasse Petit Déjeuner 27cl

ESTORIL 21079542
Chávena Pequeno Almoço 27cl
Breakfast Cup 27cl
Taza Desayuno 27cl
Tasse Petit Déjeuner 27cl
△ 264 gr A 67 mm C 114 mm L 90 mm CAP. 269 ml
△ 1/2 lbs H 2 1/2" L 4 1/2" W 3 3/8" CAP. 9 1/2 oz



ESTORIL 21100244
Chávena Chá com Pires 22cl
Tea Cup & Saucer 22cl
Taza Té con Platillo 22cl
Tasse et Sous-tasse Thé 22cl

ESTORIL 21079265
Chávena Chá 22cl
Tea Cup 22cl
Taza Té 22cl
Tasse Thé 22cl
△ 219 gr A 64 mm C 108 mm L 82 mm Ø 82 mm CAP. 217 ml
△ 1/2 lbs H 2 1/2" L 4 1/4" W 3 3/8" Ø 3 3/8" CAP. 7 1/2 oz

ESTORIL 21077817
Pires Pequeno Almoço 27cl
Breakfast Saucer 27cl
Platillo Desayuno 27cl
Sous-tasse Petit Déjeuner 27cl
△ 226 gr A 27 mm Ø 161 mm
△ 1/2 lbs H 1 1/8" Ø 6 1/8"

ESTORIL 21076276
Pires Chá 22cl
Tea Saucer 22cl
Platillo Té 22cl
Sous-tasse Thé Té 22cl
△ 202 gr A 24 mm Ø 149 mm
△ 3/8 lbs H 1" Ø 5 7/8"



ESTORIL 21079099
Chávena Chá com Pires 18cl
Tea Cup & Saucer 18cl
Taza Té con Platillo 18cl
Tasse et Sous-tasse Thé 18cl

ESTORIL 21079157
Chávena Chá 18cl
Tea Cup 18cl
Taza Té 18cl
Tasse Thé 18cl
△ 205 gr A 59 mm C 104 mm L 79 mm CAP. 181 ml
△ 3/8 lbs H 2 1/8" L 4 1/8" W 3 1/8" CAP. 6 1/8 oz



ESTORIL 21079300
Chávena Café com Pires 12cl
Coffee Cup & Saucer 12cl
Taza Café Cortado con Platillo 12cl
Tasse et Sous-tasse Café 12cl

ESTORIL 21079304
Chávena Café 12cl
Coffee Cup 12cl
Taza Café Cortado 12cl
Tasse Café 12cl
△ 148 gr A 60 mm C 87 mm L 65 mm CAP. 116 ml
△ 1/3 lbs H 2 3/8" L 3 3/8" W 2 5/8" CAP. 3 8/8 oz

ESTORIL 21076276
Pires Chá 18cl
Tea Saucer 18cl
Platillo Té 18cl
Sous-tasse Thé 18cl
△ 202 gr A 24 mm Ø 149 mm
△ 3/8 lbs H 1" Ø 5 7/8"

ESTORIL 21077296
Pires Café 12cl
Coffee Saucer 12cl
Platillo Café 12cl
Sous-tasse Café 12cl
△ 139 gr A 20 mm Ø 120 mm
△ 3/8 lbs H 7/8" Ø 4 5/8"



ESTORIL 21079444
Chávena Café com Pires 10cl
Coffee Cup & Saucer 10cl
Taza Café Cortado con Platillo 10cl
Tasse et Sous-tasse Café 10cl

ESTORIL 21079338
Chávena Café 10cl
Coffee Cup 10cl
Taza Café Cortado 10cl
Tasse Café 10cl
△ 121 gr A 50 mm C 87 mm L 65 mm CAP. 101 ml
△ 1/4 lbs H 2" L 3 3/8" W 2 5/8" CAP. 3 3/8 oz



ESTORIL 22000575
Chávena Café Moka com Pires 7cl
Moka Cup & Saucer 7cl
Taza Moka con Platillo 7cl
Tasse et Sous-tasse Moka 7cl

ESTORIL 21080424
Chávena Moka 7cl
Moka Cup 7cl
Taza Moka 7cl
Tasse Moka 7cl
△ 114 gr A 53 mm C 76 mm L 55 mm CAP. 70 ml
△ 1/4 lbs H 2 1/8" L 3" W 2 1/8" CAP. 2 3/8 oz

ESTORIL 21077296
Pires Café 10cl
Coffee Saucer 10cl
Platillo Café 10cl
Sous-tasse Café 10cl
△ 139 gr A 20 mm Ø 120 mm
△ 3/8 lbs H 7/8" Ø 4 5/8"

ESTORIL 21077296
Pires Moka 7cl
Moka Saucer 7cl
Platillo Moka 7cl
Sous-tasse Moka 7cl
△ 139 gr A 20 mm Ø 120 mm
△ 3/8 lbs H 7/8" Ø 4 5/8"



ESTORIL 21126910
Pires Chá Liso
Tea Saucer Liso
Platillo Té Liso
Sous-tasse Thé Lisse
△ 200 gr A 22 mm Ø 162 mm
△ 3/8 lbs H 7/8" Ø 6 3/8"



ESTORIL 21126911
Pires Pequeno Almoço Liso
Breakfast Saucer Liso
Platillo Desayuno Liso
Sous-tasse Petit Déjeuner Lisse
△ 235 gr A 22 mm Ø 151 mm
△ 3/8 lbs H 7/8" Ø 6"



ESTORIL 21126909
Pires Café Liso
Coffee Saucer Liso
Platillo Café Liso
Sous-tasse Café Lisse
△ 130 gr A 17 mm Ø 123 mm
△ 1/2 lbs H 3/8" Ø 4 5/8"



ESTORIL 22000565
 Saleiro
Salt
Salero
Salière
 △ 45 gr A 27 mm Ø 38 mm
 △ 1 1/10 lbs H 1 1/8" Ø 1 1/2"



ESTORIL 22000559
 Pimenteiro
Pepper
Pimentero
Poivrière
 △ 45 gr A 27 mm Ø 38 mm
 △ 1 1/10 lbs H 1 1/8" Ø 1 1/2"



ESTORIL 22000558
 Paliteiro
Toothpick Dispenser
Palillero
Porte Cure-dents
 △ 100 gr A 105 mm Ø 50 mm
 △ 3/16 lbs H 4 1/8" Ø 2"



ESTORIL 22000555
 Jarro Grande
Large Jug
Jarro Grande
Pichet Grand Modèle
 △ 850 gr A 193 mm C 157 mm L 83 mm CAP. 1181 ml
 △ 1 7/8 lbs H 7 3/8" L 6 1/8" W 3 1/4" CAP. 39 8/9 oz



ESTORIL 22000554
 Jarro Pequeno
Small Jug
Jarro Pequeno
Pichet Petit Modèle
 △ 387 gr A 143 mm C 116 mm L 59 mm CAP. 418 ml
 △ 9/16 lbs H 5 5/8" L 4 4/8" W 2 1/8" CAP. 14 1/2 oz



ESTORIL 22000553
 Jarra
Flower Vase
Violetero
Vase
 △ 222 gr A 125 mm Ø 78 mm
 △ 1/2 lbs H 4 9/8" Ø 3 1/8"





EUROPA

A funcionalidade nórdica, patente nas linhas puras, práticas e sem idade, marca o conjunto Europa, onde o espírito prático é sublinhado pela elegância geométrica.

Nordic functionality is evident in the neat, practical and ageless lines of the Europa set, where practicality is emphasized by geometric elegance.

La funcionalidad nórdica, patente en las líneas puras, prácticas y sin edad, marca el conjunto Europa, donde el espíritu práctico destaca por la elegancia geométrica.

L'esprit fonctionnel nordique, présent dans ses lignes pures, pratiques et intemporelles, marque le caractère du service Europa, souligné par l'élégance géométrique.





EUROPA 22002511
Travessa Oval Grande 37
Large Oval Platter 37
Fuente Oval Grande 37
Plat à Servir Ovale Grand Modèle 37
△ 1361 gr A 33 mm C 375 mm L 257 mm
△ 3 lbs H 1 3/4" L 14 3/4" W 10 1/8"



EUROPA 21075538
Travessa Oval Média 33
Medium Oval Platter 33
Fuente Oval Mediana 33
Plat à Servir Ovale Moyen 33
△ 1007 gr A 29 mm C 331 mm L 228 mm
△ 2 3/8 lbs H 1 1/2" L 13" W 9"



EUROPA 21075593
Travessa Oval Média 29
Medium Oval Platter 29
Fuente Oval Mediana 29
Plat à Servir Ovale Moyen 29
△ 764 gr A 26 mm C 298 mm L 204 mm
△ 1 7/8 lbs H 1" L 11 3/4" W 8"



EUROPA 21075657
Travessa Oval Pequena 25
Small Oval Platter 25
Fuente Oval Pequeña 25
Plat à Servir Ovale Petit Modèle 25
△ 480 gr A 22 mm C 254 mm L 175 mm
△ 1 1/8 lbs H 7/8" L 10" W 6 7/8"



EUROPA 21075292
Prato Raso 28
Dinner Plate 28
Plato Llano 28
Assiette Plate 28
△ 774 gr A 27 mm Ø 275 mm
△ 1 5/8 lbs H 1 1/8" Ø 10 7/8"



EUROPA 21075318
Prato Raso 25
Dinner Plate 25
Plato Llano 25
Assiette Plate 25
△ 662 gr A 27 mm Ø 248 mm
△ 1 3/8 lbs H 1 1/8" Ø 9 3/4"



EUROPA 21075349
Prato Raso 23
Dinner Plate 23
Plato Llano 23
Assiette Plate 23
△ 553 gr A 25 mm Ø 227 mm
△ 1 3/8 lbs H 1" Ø 8 7/8"



EUROPA 22002536
Prato Sopa 21
Soup Plate 21
Plato Sopa 21
Assiette Creuse 21
△ 428 gr A 37 mm Ø 205 mm CAP. 400 ml
△ 9/8 lbs H 1 3/8" Ø 8 1/8" CAP. 13 1/2 oz



EUROPA 22002532
Prato Sobremesa 19
Dessert Plate 19
Plato Postre 19
Assiette à Dessert 19
△ 336 gr A 21 mm Ø 188 mm
△ 3/4 lbs H 5/8" Ø 7 3/8"



EUROPA 22002533
Prato Doce 15
Bread & Butter Plate 15
Plato Pan 15
Assiette à Dessert 15
△ 183 gr A 18 mm Ø 148 mm
△ 3/8 lbs H 5/8" Ø 5 7/8"



EUROPA 22000562
Prato Salada 1/2 Lua
Salad Plate 1/2 Moon
Plato Ensalada 1/2 Luna
Assiette à Salade 1/2 Luna
△ 257 gr A 24 mm C 201 mm L 115 mm
△ 1/2 lbs H 1" L 7 3/8" W 4 1/2"



EUROPA 22000566
Terrina 267cl
Tureen 267cl
Sopera 267cl
Soupière 267cl
△ 3205 gr A 154 mm C 270 mm L 221 mm CAP. 2676 ml
△ 7 1/8 lbs H 6 1/8" L 10 3/8" W 8 3/8" CAP. 90 1/2 oz



EUROPA 21075773
Saladeira Redonda Grande 23
Large Round Salad Bowl 23
Ensaladera Redonda Grande 23
Saladier Rond Grand Modèle 23
△ 1040 gr A 74 mm Ø 232 mm CAP. 2143 ml
△ 2 3/8 lbs H 2 7/8" Ø 9 1/8" CAP. 72 3/8 oz



EUROPA 21075852
Saladeira Redonda Média 19
Medium Round Salad Bowl 19
Ensaladera Redonda Mediana 19
Saladier Rond Moyen 19
△ 754 gr A 63 mm Ø 189 mm CAP. 1112 ml
△ 1 3/8 lbs H 2 1/2" Ø 7 4/8" CAP. 37 3/8 oz



EUROPA 21075906
Saladeira Redonda Pequena 16
Small Round Salad Bowl 16
Ensaladera Redonda Pequeña 16
Saladier Rond Petit Modèle 16
△ 433 gr A 55 mm Ø 161 mm CAP. 704 ml
△ 1 lbs H 2 1/8" Ø 6 1/8" CAP. 23 3/8 oz



EUROPA 21076020
Saladeira Quadrada Grande 18
Large Square Salad Bowl 18
Ensaladera Cuadrada Grande 18
Saladier Carré Grand Modèle 18
△ 570 gr A 55 mm C 178 mm L 178 mm CAP. 651 ml
△ 1 1/4 lbs H 2 1/8" L 7" W 7" CAP. 22 oz



EUROPA 21075978
Saladeira Quadrada Média 15
Medium Square Salad Bowl 15
Ensaladera Cuadrada Mediana 15
Saladier Carré Moyen 15
△ 478 gr A 53 mm C 147 mm L 147 mm CAP. 477 ml
△ 1 lbs H 2 1/8" L 5 7/8" W 5 7/8" CAP. 16 1/8 oz



EUROPA 21075999
Saladeira Quadrada Pequena 13
Small Square Salad Bowl 13
Ensaladera Cuadrada Pequeña 13
Saladier Carré Petit Modèle 13
△ 324 gr A 46 mm C 127 mm L 127 mm CAP. 308 ml
△ 3/4 lbs H 1 1/2" L 5" W 5" CAP. 10 3/4 oz



EUROPA 22000574
Chávena Consomé com Pires 30cl
Consomme Cup & Saucer 30cl
Taza Consomé con Platillo 30cl
Tasse et Soucoupe Bouillon 30cl

EUROPA 21076121
Chávena Consomé 30cl
Consomme Cup 30cl
Taza Consomé 30cl
Tasse Bouillon 30cl
△ 298 gr A 60 mm C 148 mm L 100 mm CAP. 306 ml
△ 3/5 lbs H 2 3/8" L 5 5/8" W 3 8/9" CAP. 10 1/3 oz

EUROPA 21077817
Pires Consomé 30cl
Consomme Saucer 30cl
Platillo Consomé 30cl
Soucoupe Bouillon 30cl
△ 239 gr A 26 mm Ø 161 mm
△ 1/2 lbs H 1" Ø 6 1/2"



EUROPA 21098061
Tigela com Asas 13
Bowl with Handles 13
Bowl con Alas 13
Coupe avec Poignées 13
△ 276 gr A 54 mm C 136 mm L 117 mm CAP. 312 ml
△ 3/5 lbs H 2 1/8" L 5 3/8" W 4 3/8" CAP. 10 5/8 oz



EUROPA 21078078
Tigela Grande 10
Large Bowl 10
Bowl Grande 10
Coupe Grand Modèle 10
△ 277 gr A 60 mm Ø 101 mm CAP. 286 ml
△ 3/5 lbs H 2 1/2" Ø 4" CAP. 9 2/3 oz



EUROPA 21078078
Tigela Pequena 12
Small Bowl 12
Bowl Pequeña 12
Coupe Petit Modèle 12
△ 336 gr A 63 mm Ø 122 mm CAP. 418 ml
△ 3/4 lbs H 2 1/2" Ø 4 3/4" CAP. 14 1/2 oz



EUROPA 21077089
Leiteira Grande 28cl
Large Milk Jug 28cl
Lechera Grande 28cl
Crémier Grand Modèle 28cl
△ 335 gr A 84 mm C 123 mm L 83 mm CAP. 279 ml
△ 3/4 lbs H 3 3/4" L 4 3/8" W 3 1/4" CAP. 9 3/4 oz



EUROPA 21077145
Leiteira Pequena 16cl
Small Milk Jug 16cl
Lechera Pequeña 16cl
Crémier Petit Modèle 16cl
△ 204 gr A 67 mm C 106 mm L 70 mm CAP. 157ml
△ 9/16 lbs H 2 5/8" L 4 1/8" W 2 3/4" CAP. 5 3/4 oz



EUROPA 21076484
Açucareiro
Sugar Bowl
Azucarero
Sucrier
△ 318 gr A 61 mm Ø 96 mm CAP. 260 ml
△ 3/7 lbs H 2 3/8" Ø 3 3/8" CAP. 8 1/2 oz



EUROPA 21076701
 Bule Grande 65cl
Large Tea Pot 65cl
Tetera Grande 65cl
Théière Grand Modèle 65cl
 △ 777 gr A 109 mm C 175 mm L 129 mm CAP. 716 ml
 △ 1 5/8 lbs H 4 3/8" L 6 5/8" W 5 1/8" CAP. 24 1/2 oz



EUROPA 21076897
 Bule Pequeno 35cl
Small Tea Pot 35cl
Tetera Pequeña 35cl
Théière Petit Modèle 35cl
 △ 457 gr A 92 mm C 145 mm L 104 mm CAP. 381 ml
 △ 1 lbs H 3 3/8" L 5 5/8" W 4" CAP. 12 5/8 oz



EUROPA 21077499
 Cafeteira Grande 60cl
Large Coffee Pot 60cl
Cafetera Grande 60cl
Cafetière Grand Modèle 60cl
 △ 732 gr A 128 mm C 153 mm L 102 mm CAP. 571 ml
 △ 1 5/8 lbs H 5" L 6" W 4" CAP. 19 3/8 oz



EUROPA 21077624
 Cafeteira Pequena 30 cl
Small Coffee Pot 30cl
Cafetera Pequeña 30cl
Cafetière G Petit Modèle 30cl
 △ 431 gr A 100 mm C 127 mm L 87 mm CAP. 314 ml
 △ 1 lbs H 3 3/8" L 5" W 3 3/8" CAP. 10 5/8 oz



EUROPA 22000573
 Chávena Pequeno Almoço com Pires 30cl
Breakfast Cup & Saucer 30cl
Taza Desayuno con Platillo 30cl
Tasse et Sous-tasse Petit Déjeuner 30cl
 △ 279 gr A 60 mm C 124 mm L 102 mm
 Ø 303 mm CAP. 303 ml
 △ 5/8 lbs H 2 3/8" L 4 7/8" W 4"
 Ø 11 5/8" CAP. 10 1/4 oz

EUROPA 21077744
 Chávena Pequeno Almoço 30cl
Breakfast Cup 30cl
Taza Desayuno 30cl
Tasse Petit Déjeuner 30cl
 △ 279 gr A 60 mm C 124 mm L 102 mm
 Ø 303 mm CAP. 303 ml
 △ 5/8 lbs H 2 3/8" L 4 7/8" W 4"
 Ø 11 5/8" CAP. 10 1/4 oz



EUROPA 21076459
 Chávena Chá com Pires 22cl
Tea Cup & Saucer 22cl
Taza Té con Platillo 22cl
Tasse et Sous-tasse Thé 22cl
 △ 212 gr A 57 mm C 113 mm L 92 mm CAP. 222 ml
 △ 4/8 lbs H 2 1/4" L 4 1/8" W 3 3/8" CAP. 7 1/2 oz

EUROPA 21076463
 Chávena Chá 22cl
Tea Cup 22cl
Taza Té 22cl
Tasse Thé 22cl
 △ 212 gr A 57 mm C 113 mm L 92 mm CAP. 222 ml
 △ 4/8 lbs H 2 1/4" L 4 1/8" W 3 3/8" CAP. 7 1/2 oz



EUROPA 22000572
 Chávena Chá com Pires 18cl
Tea Cup & Saucer 18cl
Taza Té con Platillo 18cl
Tasse et Sous-tasse Thé 18cl
 △ 179 gr A 57 mm C 105 mm L 84 mm CAP. 177 ml
 △ 3/8 lbs H 2 1/4" L 4 1/8" W 3 3/8" CAP. 6 oz

EUROPA 21076208
 Chávena Chá 18cl
Tea Cup 18cl
Taza Té 18cl
Tasse Thé 18cl
 △ 179 gr A 57 mm C 105 mm L 84 mm CAP. 177 ml
 △ 3/8 lbs H 2 1/4" L 4 1/8" W 3 3/8" CAP. 6 oz



EUROPA 22000571
 Chávena Café com Pires 10cl
Coffee Cup & Saucer 10cl
Taza Café con Platillo 10cl
Tasse et Sous-tasse Café 10cl
 △ 107 gr A 47 mm C 90 mm L 68 mm CAP. 104 ml
 △ 3/8 lbs H 1 5/8" L 3 3/8" W 2 3/8" CAP. 3 1/2 oz

EUROPA 22002528
 Chávena Café 10cl
Coffee Cup 10cl
Taza Café 10cl
Tasse Café 10cl
 △ 107 gr A 47 mm C 90 mm L 68 mm CAP. 104 ml
 △ 3/8 lbs H 1 5/8" L 3 3/8" W 2 3/8" CAP. 3 1/2 oz

EUROPA 21076276
 Pires Chá 18cl
Tea Saucer 18cl
Platillo Té 18cl
Sous-tasse Thé 18cl
 △ 234 gr A 24 mm Ø 149 mm
 △ 1/2 lbs H 1" Ø 5 7/8"

EUROPA 21077296
 Pires Café 10cl
Coffee Saucer 10cl
Platillo Café 10cl
Sous-tasse Café 10cl
 △ 144 gr A 20 mm Ø 121 mm
 △ 1/2 lbs H 7/8" Ø 4 3/4"



LUNA

Luna é um modelo abrangente concebido para satisfazer todos os requisitos dos melhores profissionais de restauração e hotelaria, consistindo numa gama completa de mais de 60 itens, que abrange serviço de mesa e diversos artigos para forno. Um clássico moderno, adaptável a qualquer ambiente, elegante e muito resistente, sendo todos os pratos reforçados para maior resistência ao impacto.

Luna is an all-round model, designed to meet every requirement of top catering professionals, comprising a full range of over 60 pieces, from tableware to various oven items. A modern classic, adaptable to any environment, elegant and very sturdy - all plates are reinforced for greater impact resistance.

Luna es un modelo amplio creado para satisfacer todos los requisitos de los mejores profesionales de la restauración y la hostelería que consiste en una gama completa de más de 60 piezas, incluyendo vajilla de mesa y varios accesorios para horno. Modelo clásico y a la vez moderno que se adapta a cualquier clase de ambiente, elegante y muy resistente, siendo reforzados todos los platos para una mayor resistencia al impacto.

Luna est un modèle complet, conçu pour répondre à toutes les exigences des meilleurs professionnels de la restauration et de l'hôtellerie, composé d'une gamme complète de plus de 60 articles, couvrant le service de table et divers plats à four. Un service classique, moderne, adaptable à tout environnement, élégant et très résistant, toutes les assiettes étant renforcées pour une plus grande résistance aux chocs.



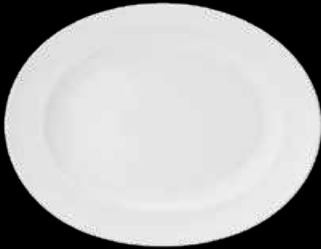

LUNA 21081872
Travessa Grande 40
Large platter 40
Fuente Grande 40
Plat à Servir Grand Modèle 40
△ 1712 gr A 43 mm C 391 mm L 346 mm
△ 3 7/8 lbs H 1 3/4" L 15 3/8" W 13 5/8"

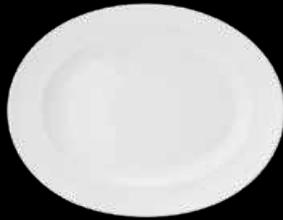

LUNA 21081873
Travessa Média 34
Medium Platter 34
Fuente Mediana 34
Plat à Servir Moyen 34
△ 1105 gr A 40 mm C 335 mm L 278 mm
△ 2 3/8 lbs H 1 3/4" L 13 1/8" W 11"



LUNA 21081874
Travessa Média 29
Medium Platter 29
Fuente Mediana 29
Plat à Servir Moyen 29
△ 704 gr A 33 mm C 288 mm L 237 mm
△ 1 3/8 lbs H 1 3/4" L 11 1/8" W 9 1/8"



LUNA 21081875
Travessa Pequena 26
Small Platter 26
Fuente Pequeña 26
Plat à Servir Petit Modèle 26
△ 532 gr A 32 mm C 256 mm L 216 mm
△ 1 1/8 lbs H 1 1/4" L 10 1/8" W 8 1/2"



LUNA 21081862
Prato Raso 30
Dinner Plate 30
Plato Llano 30
Assiette Plate 30
△ 931 gr A 33 mm Ø 299 mm
△ 2 lbs H 1 3/4" Ø 11 7/8"



LUNA 21081866
Prato Raso 28
Dinner Plate 28
Plato Llano 28
Assiette Plate 28
△ 871 gr A 32 mm Ø 281 mm
△ 1 5/8 lbs H 1 1/4" Ø 11 1/8"



LUNA 21081867
Prato Raso 26
Dinner Plate 26
Plato Llano 26
Assiette Plate 26
△ 637 gr A 29 mm Ø 261 mm
△ 1 3/8 lbs H 1 1/4" Ø 10 3/4"



LUNA 21081877
Prato Pasta 30
Pasta Plate 30
Plato Pasta 30
Assiette à Pâtes 30
△ 874 gr A 42 mm Ø 303 mm CAP. 592 ml
△ 1 5/8 lbs H 1 3/4" Ø 11 5/8" CAP. 20 oz



LUNA 21081871
Prato Sopa Grande 28
Large Soup Plate 28
Plato Hondo Grande 28
Assiette Creuse Grand Modèle 28
△ 886 gr A 41 mm Ø 280 mm CAP. 168 ml
△ 2 lbs H 1 3/4" Ø 11" CAP. 5 2/3 oz



LUNA 21081868
Prato Sopa Pequeno 24
Small Soup Plate 24
Plato Hondo Pequeño 24
Assiette Creuse Petit Modèle 24
△ 530 gr A 36 mm Ø 241 mm CAP. 288 ml
△ 1 1/8 lbs H 1 3/4" Ø 9 1/2" CAP. 9 3/4 oz



LUNA 21081869
Prato Sobremesa 22
Dessert Plate 22
Plato Postre 22
Assiette à Dessert 22
△ 415 gr A 25 mm Ø 218 mm
△ 8/8 lbs H 1" Ø 8 4/8"



LUNA 21081870
Prato Pão 17
Bread & Butter Plate 17
Plato Pan 17
Assiette à Pain 17
△ 220 gr A 21 mm Ø 167 mm
△ 1/2 lbs H 5/8" Ø 6 4/8"



LUNA 21081893
Prato Manteiga 10
Butter Plate 10
Plato Mantequilla 10
Assiette à Beurre 10
△ 83 gr A 21 mm Ø 101 mm
△ 1/8 lbs H 5/8" Ø 4"



LUNA 21091323
Prato Buffet 1/2 Lua
Buffet 1/2 Moon Plate
Plato Buffet 1/2 Luna
Assiette Buffet 1/2 Luna
△ 1196 gr A 61 mm C 292 mm L 205 mm
△ 2 3/8 lbs H 2 3/8" L 11 1/2" W 8 1/8"



LUNA 21091312
Prato Redondo Buffet 30
Buffet Round Plate 30
Plato Redondo Buffet 30
Assiette Ronde Buffet 30
△ 1614 gr A 60 mm C 292 mm L 300 mm CAP. 301 ml
△ 3 3/8 lbs H 2 3/8" L 11 1/2" W 11 5/8" CAP. 11 5/8 oz



LUNA 21091313
Prato Aperitivos 32
Aperitifs Plate 32
Plato Aperitivos 32
Palt A pèritifs 32
△ 1207 gr A 39 mm Ø 323 mm
△ 2 2/8 lbs H 1 5/8" Ø 12 5/8"



LUNA 21090838
Prato Oval Buffet 17
Buffet Oval Plate 17
Plato Oval Buffet 17
Assiette Ovale Buffet 17
△ 464 gr A 61 mm C 170 mm L 127 mm
△ 1 lbs H 2 3/8" L 6 5/8" W 5"



LUNA 21081880
Prato 1/2 Lua
Plate 1/2 Moon
Plato 1/2 Luna
Assiette 1/2 Luna
△ 373 gr A 28 mm C 223 mm L 148 mm
△ 3/6 lbs H 1 1/8" L 8 7/8" W 5 5/8"



LUNA 21090839
Conserveira
Olive Dish
Rabanera
Ravier
△ 227 gr A 32 mm C 177 mm L 118 mm
△ 1/2 lbs H 1 1/4" L 7" W 4 5/8"



LUNA 21081879
Terrina 337cl
Tureen 337cl
Sopera 337cl
Soupière 337cl
△ 1969 gr A 187 mm C 277 mm L 222 mm Ø 222 mm CAP. 3378 ml
△ 4 1/3 lbs H 7 3/8" L 10 9/16" W 8 3/4" Ø 8 3/4" CAP. 114 3/8 oz



LUNA 21081884
Saladeira Pequena 16
Small Salad Bowl 16
Ensaladera Pequeña 16
Saladier Petit Modèle 16
△ 369 gr A 61 mm Ø 161 mm CAP. 751 ml
△ 3/5 lbs H 2 3/8" Ø 6 1/8" CAP. 25 3/8 oz



LUNA 21081883
Saladeira Média 23
Medium Salad Bowl 23
Ensaladera Mediana 23
Saladier Moyen 23
△ 977 gr A 89 mm Ø 232 mm CAP. 2325 ml
△ 2 1/5 lbs H 3 1/2" Ø 9 1/8" CAP. 78 5/8 oz



LUNA 21081882
Saladeira Grande 28
Large Salad Bowl 28
Ensaladera Grande 28
Saladier Grand Modèle 28
△ 1515 gr A 100 mm Ø 280 mm CAP. 3778 ml
△ 3 1/5 lbs H 3 3/8" Ø 11" CAP. 127 3/4 oz



LUNA 21081878
Chávena Consomé com Pires Emp. 29cl
St Consomme Cup & Saucer 29cl
Taza Consomé con Platillo St 29cl
Tasset et Soucoupe Bouillon Emp. 29cl

LUNA 21082111
Chávena Consomé Emp. 29cl
St Consomme Cup 29cl
Taza Consomé St 29cl
Tasset Bouillon Emp. 29cl
△ 262 gr A 53 mm Ø 107 mm CAP. 295 ml
△ 3/7 lbs H 2 1/8" Ø 4 2/8" CAP. 10 oz



LUNA 21081885
Molheira com Prato 38cl
Sauceboat & Stand 38cl
Salsera con Platillo 38cl
Saucière avec Soucoupe 38cl

LUNA 21085420
Molheira 38cl
Sauceboat 38cl
Salsera 38cl
Saucière 38cl
△ 246 gr A 84 mm Ø 99 mm CAP. 378 ml
△ 3/9 lbs H 3 3/8" Ø 3 3/8" CAP. 12 7/8 oz

LUNA 21082118
Pires Consomé 29cl
St Consomme Saucer 29cl
Platillo Consomé St 29cl
Soucoupe Bouillon Emp. 29cl
△ 246 gr A 22 mm Ø 173 mm
△ 3/6 lbs H 7/8" Ø 6 4/8"

LUNA 21082114
Prato Molheira Nemp 38cl
Nst Sauceboat Stand 38cl
Platillo Salsera Nst 38cl
Soucoupe Saucière Nemp 38cl
△ 271 gr A 24 mm Ø 172 mm
△ 3/5 lbs H 1" Ø 6 7/8"



LUNA 21081902
Tigela Cereais Nemp 14
Nst Cereal Bowl 14
Bowl Cereales Nst 14
Bol Céréales Nemp 14
△ 291 gr A 59 mm Ø 143 mm CAP. 557 ml
△ 3/8 lbs H 2 1/8" Ø 5 5/8" CAP. 18 5/8 oz



LUNA 21081903
Tigela Cereais Emp. 13
St. Cereal Bowl 13
Bowl Cereales St. 13
Bol Céréales Emp. 13
△ 331 gr A 62 mm Ø 133 mm CAP. 556 ml
△ 3/7 lbs H 2 3/8" Ø 5 1/4" CAP. 18 1/8 oz



LUNA 21081904
Tigela Cereais Emp. 15
St. Cereal Bowl 15
Bowl Cereales St. 15
Bol Céréales Emp. 15
△ 420 gr A 64 mm Ø 146 mm CAP. 641 ml
△ 8/9 lbs H 2 1/2" Ø 5 3/4" CAP. 21 3/8 oz



LUNA 21090220
Tigela com Asas 11
Bowl with Handles 11
Bowl con Asas 11
Coupe avec Poignées 11
△ 224 gr A 46 mm C 136 mm L 118 mm CAP. 295 ml
△ 1/2 lbs H 1 1/8" L 5 3/8" W 4 5/8" CAP. 10 oz



LUNA 21081894
Leiteira Grande 35cl
Large Milk Jug 35cl
Lechera Grande 35cl
Crémier Grand Modèle 35cl
△287 gr A 108 mm C 128 mm L 86 mm CAP. 349 ml
△ $\frac{3}{8}$ lbs H 4 $\frac{1}{4}$ " L 5" W 3 $\frac{3}{8}$ " CAP. 11 $\frac{4}{5}$ oz



LUNA 21081895
Leiteira Pequena 11cl
Small Milk Jug 11cl
Lechera Pequeña 11cl
Crémier Petit Modèle 11cl
△226 gr A 94 mm C 108 mm L 73 mm CAP. 109 ml
△ $\frac{1}{2}$ lbs H 3 $\frac{5}{8}$ " L 4 $\frac{1}{4}$ " W 2 $\frac{7}{8}$ " CAP. 3 $\frac{2}{3}$ oz



LUNA 21081896
Açucareiro
Sugar Bowl
Azucarero
Sucrier
△306 gr A 89 mm Ø 95 mm CAP. 246 ml
△ $\frac{3}{5}$ lbs H 3 $\frac{1}{2}$ " Ø 3 $\frac{3}{4}$ " CAP. 8 $\frac{1}{3}$ oz



LUNA 21081897
Açucareiro Pacotes
Sugar Box
Azucarero Paquetes
Sucrier Sachets de Sucre
△231 gr A 57 mm C 110 mm L 80 mm CAP. 274 ml
△ $\frac{1}{2}$ lbs H 2 $\frac{1}{4}$ " L 4 $\frac{1}{8}$ " W 3 $\frac{1}{2}$ " CAP. 9 $\frac{1}{4}$ oz



LUNA 21081898
Bule Grande 90cl
Large Tea Pot 90cl
Tetera Grande 90cl
Théière Grand Modèle 90cl
△657 gr A 135 mm C 202 mm L 129 mm CAP. 846 ml
△1 $\frac{4}{5}$ lbs H 5 $\frac{1}{8}$ " L 8" W 5 $\frac{1}{8}$ " CAP. 28 $\frac{2}{3}$ oz



LUNA 21081899
Bule Pequeno 40cl
Small Tea Pot 40cl
Tetera Pequeña 40cl
Théière Petit Modèle 40cl
△965 gr A 113 mm C 170 mm L 104 mm CAP. 436 ml
△2 $\frac{1}{5}$ lbs H 4 $\frac{5}{8}$ " L 6 $\frac{5}{8}$ " W 4 $\frac{1}{8}$ " CAP. 14 $\frac{3}{4}$ oz



LUNA 21081900
Cafeteira Grande 90cl
Large Coffee Pot 90cl
Cafetera Grande 90cl
Cafetière Grand Modèle 90cl
△609 gr A 159 mm C 198 mm L 117 mm CAP. 937 ml
△1 $\frac{1}{3}$ lbs H 6 $\frac{1}{4}$ " L 7 $\frac{3}{4}$ " W 4 $\frac{3}{8}$ " CAP. 31 $\frac{2}{3}$ oz



LUNA 21081901
Cafeteira Pequena 45cl
Small Coffee Pot 45cl
Cafetera Pequena 45cl
Cafetière Petit Modèle 45cl
△409 gr A 129 mm C 156 mm L 95 mm CAP. 447 ml
△ $\frac{3}{5}$ lbs H 5 $\frac{1}{8}$ " L 6 $\frac{1}{8}$ " W 3 $\frac{3}{4}$ " CAP. 15 $\frac{1}{2}$ oz



LUNA 21081876
Caneca 30cl
Mug 30cl
Mug 30cl
Mug 30cl
△242 gr A 94 mm C 111 mm L 83 mm Ø 83 mm CAP. 307 ml
△ $\frac{3}{8}$ lbs H 3 $\frac{5}{8}$ " L 4 $\frac{3}{8}$ " W 3 $\frac{1}{4}$ " Ø 3 $\frac{1}{4}$ " CAP. 10 $\frac{3}{8}$ oz



LUNA 21081886
Chávena Pequeno Almoço com Pires Nemp 33cl
Nst Breakfast Cup & Saucer 33cl
Taza Desayuno con Platillo Nst 33cl
Tasse et Sous-tasse Petit Déjeuner Nemp 33cl

LUNA 21082106
Chávena Pequeno Almoço Nemp 33cl
Nst Breakfast Cup 33cl
Taza Desayuno Nst 33cl
Tasse Petit Déjeuner Nemp 33cl
△265 gr A 63 mm Ø 110 mm CAP. 330 ml
△ $\frac{4}{5}$ lbs H 2 $\frac{1}{2}$ " Ø 4 $\frac{1}{8}$ " CAP. 11 $\frac{1}{6}$ oz

LUNA 21082114
Pires Pequeno Almoço Nemp 33cl
Nst Breakfast Saucer 33cl
Platillo Desayuno Nst 33cl
Sous-tasse Petit Déjeuner Nemp 33cl
△271 gr A 24 mm Ø 171 mm
△ $\frac{3}{5}$ lbs H 1" Ø 6 $\frac{3}{4}$ "



LUNA 21081888
Chávena Chá com Pires Emp. 22cl
St Tea Cup & Saucer 22cl
Taza Té con Platillo St 22cl
Tasse et Sous-tasse Thé Emp. 22cl

LUNA 21082110
Chávena Chá Emp. 22cl
St Tea Cup 22cl
Taza Té St 22cl
Tasse Thé Emp. 22cl
△227 gr A 62 mm Ø 85 mm CAP. 223 ml
△ $\frac{1}{2}$ lbs H 2 $\frac{4}{8}$ " Ø 3 $\frac{1}{8}$ " CAP. 7 $\frac{5}{8}$ oz



LUNA 21081889
Chávena Chá com Pires Nemp 26cl
Nst Tea Cup & Saucer 26cl
Taza Té con Platillo Nst 26cl
Tasse et Sous-tasse Thé Nemp 26cl

LUNA 21082104
Chávena Chá Nemp 26cl
Nst Tea Cup 26cl
Taza Té Nst 26cl
Tasse Thé Nemp 26cl
△187 gr A 65 mm Ø 94 mm CAP. 260 ml
△ $\frac{3}{5}$ lbs H 2 $\frac{3}{8}$ " Ø 3 $\frac{5}{8}$ " CAP. 9 $\frac{3}{8}$ oz

LUNA 21082117
Pires Pequeno Emp. 22cl
St Tea Saucer 22cl
Platillo Té St 22cl
Sous-tasse Thé Emp. 22cl
△208 gr A 25 mm Ø 155 mm
△ $\frac{4}{5}$ lbs H 1" Ø 6 $\frac{1}{8}$ "

LUNA 21082113
Pires Chá Nemp 26cl
Nst Tea Saucer 26cl
Platillo Té Nst 26cl
Sous-tasse Thé Nemp 26cl
△220 gr A 25 mm Ø 157 mm
△ $\frac{1}{2}$ lbs H 1" Ø 6 $\frac{1}{8}$ "



LUNA 21081892
Chávena Café com Pires Alemão Emp. 15cl
Coffee Cup & Saucer German St. 15cl
Taza Café Cort. con Platillo St. 15cl
Tasse et Sous-tasse Café Allemand Emp. 15cl

LUNA 21082107
Chávena Café Alemão Emp. 15cl
St German Coffee Cup 15cl
Taza Café Cort. St 15cl
Tasse Café Allemand 15cl Emp. 15cl
△ 136 gr A 53 mm Ø 74 mm CAP. 150 ml
△ 3/8 lbs H 2 1/8" Ø 2 3/8" CAP. 5 oz



LUNA 21082112
Chávena Café Nemp. 9cl
Nst. Coffee Cup 9cl
Taza Café Nst. 9cl
Tasse Café Nemp. 9cl
△ 79 gr A 44 mm Ø 66 mm CAP. 85 ml
△ 1/6 lbs H 1 3/4" Ø 2 3/8" CAP. 2 7/8 oz

LUNA 21082115
Pires Café Alemão Emp. 15cl
St German Coffee Saucer 15cl
Platillo Café Cort. St 15cl
Sous-tasse Café Allemand 15cl Emp. 15cl
△ 165 gr A 22 mm Ø 138 mm
△ 3/8 lbs H 7/8" Ø 5 3/8"

LUNA 21081891
Chávena Café com Pires Nemp. 9cl
Nst. Coffee Cup & Saucer 9cl
Taza Café con Platillo Nst. 9cl
Tasse et Sous-tasse Café Nemp. 9cl

LUNA 21082119
Pires Café Nemp. 9cl
Nst. Coffee Saucer 9cl
Platillo Café Nst. 9cl
Sous-tasse Café Nemp 410/09
△ 98 gr A 21 mm Ø 114 mm
△ 3/8 lbs H 3/8" Ø 4 1/2"



LUNA 21081890
Chávena Café com Pires Emp. 9cl
St. Coffee Cup & Saucer 9cl
Taza Café con Platillo St. 9cl
Tasse et Sous-tasse Café Emp. 9cl

LUNA 21082108
Chávena Café Emp. 9cl
St. Coffee Cup 9cl
Taza Café St. 9cl
Tasse Café Emp. 9cl
△ 101 gr A 48 mm Ø 60 mm CAP. 85 ml
△ 3/8 lbs H 1 1/8" Ø 2 3/8" CAP. 2 7/8 oz



LUNA 21082116
Pires Café Emp. 9cl
St. Coffee Saucer 9cl
Platillo Café St. 9cl
Sous-tasse Café Emp. 9cl
△ 115 gr A 20 mm Ø 118 mm
△ 1/4 lbs H 7/8" Ø 4 3/8"

LUNA 21081906
Saleiro
Salt
Salero
Salière
△ 66 gr A 75 mm Ø 53 mm
△ 1/2 lbs H 3" Ø 2 1/8"

LUNA 21081907
Pimenteiro
Pepper
Pimentero
Poivrière
△ 66 gr A 75 mm Ø 53 mm
△ 1/2 lbs H 3" Ø 2 1/8"



LUNA 21081905
Oveiro
Egg Cup
Huevera
Coquetier
△ 138 gr A 23 mm Ø 121 mm
△ 3/8 lbs H 9/8" Ø 4 3/4"



LUNA 21081908
Paliteiro Aberto
Toothpick Container
Palillero Abierto
Porte Cure-dents Ouvert
△ 81 gr A 64 mm C 58 mm L 44 mm
△ 1/6 lbs H 2 1/2" L 2 3/4" W 1 3/4"



LUNA 21081909
Paliteiro
Toothpick Dispenser
Palillero
Porte Cure-dents
△ 125 gr A 95 mm C 63 mm L 45 mm
△ 3/8 lbs H 3 3/4" L 2 1/2" W 1 7/8"



LUNA 21081911
Cinzeiro
Ashtray
Cenicero
Cendrier
△ 175 gr A 23 mm Ø 120 mm
△ 3/8 lbs H 9/8" Ø 4 3/4"



LUNA 21081912
Cinzeiro Água
Water Ashtray
Cenicero Agua
Cendrier à Eau
△ 283 gr A 65 mm Ø 97 mm CAP. 232 ml
△ 5/8 lbs H 2 5/8" Ø 3 3/8" CAP. 7 5/8 oz



LUNA 21081913
Vaso
Vase
Florero
Vase
△ 376 gr A 121 mm Ø 85 mm
△ 3/6 lbs H 4 3/4" Ø 3 1/8"



LUNA 21081910
Castiçal
Candlestick
Cadelabro
Porte-bougies
△ 148 gr A 52 mm Ø 79 mm
△ 1/3 lbs H 2" Ø 3 1/8"





PERLA

Um modelo moderno de hotelaria com um toque clássico e requintado, desenvolvido para uso diário e exigente. As suas formas distintas e resistentes fazem de *Perla* a escolha certa para profissionais. Todas as peças ostentam pérolas ovais embutidas, criando uma original marca de distinção.

A modern hotel model with a touch of class and refinement, developed for demanding, every-day use. Its distinct and robust shapes make the Perla the right choice for professionals. All pieces bear an inlaid oval pearl, creating a unique mark of distinction.

Un modelo moderno de hostelería con un toque clásico y refinado, creado para uso diario y exigente. Sus variadas y resistentes formas hacen del modelo Perla la elección correcta para profesionales. Todas las piezas ostentan perlas ovales incrustadas, creando una original marca distintiva.

Un modèle moderne d'hôtellerie avec une touche de classique et raffiné, développé pour un usage quotidien et exigeant. Ses formes singulières et résistantes font de la collection Perla le bon choix pour les professionnels. Toutes les pièces exhibent des perles ovales incrustées, créant ainsi un signe de distinction original.



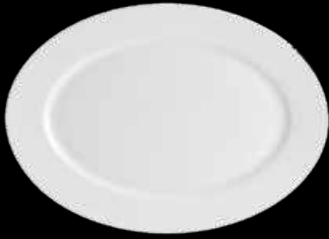

PERLA 21101972
Travessa Grande 37
Large Oval Platter 37
Fuente Oval Grande 37
Plat à Servir Ovale Grand Modèle 37
△1437 gr A 31 mm C 374 mm L 284 mm
△3 1/8 lbs H 1 3/8" L 14 5/8" W 11 1/8"



PERLA 21101973
Travessa Pequena 33
Small Oval Platter 33
Fuente Oval Pequeño 33
Plat à Servir Ovale Petit Modèle 33
△958 gr A 26 mm C 330 mm L 261 mm
△2 1/8 lbs H 1" L 13" W 10 3/8"



PERLA 21101960
Prato Marcador 32
Charger Plate 32
Plato Presentación 32
Assiette de Présentation 32
△1142 gr A 24 mm C 321 mm
△2 1/2 lbs H 1" L 12 5/8"



PERLA 21101961
Prato Raso 29,5
Dinner Plate 29,5
Plato Llano 29,5
Assiette Plate 29,5
△968 gr A 24 mm C 296 mm
△2 1/8 lbs H 1" L 11 3/8"



PERLA 21101962
Prato Raso 27
Dinner Plate 27
Plato Llano 27
Assiette Plate 27
△728 gr A 23 mm C 266 mm
△1 3/8 lbs H 8/8" L 10 1/2"



PERLA 21101963
Prato Raso 25
Prato Raso 25
Plato Llano 25
Assiette Plate 25
△595 gr A 21 mm C 249 mm
△1 1/8 lbs H 3/8" L 9 5/8"



PERLA 21116454
Prato Pasta 32
Pasta Plate 32
Plato Pasta 32
Assiette à Pâtes 32
△1160 gr A 70 mm C 320 mm CAP. 962 ml
△2 3/8 lbs H 2 3/4" L 12 3/8" CAP. 32 1/2 oz



PERLA 21101984
Prato Pasta 24
Pasta Plate 24
Plato Pasta 24
Assiette à Pâtes 24
△584 gr A 58 mm C 244 mm CAP. 443 ml
△1 3/8 lbs H 2 3/8" L 9 3/8" CAP. 15 oz



PERLA 21101964
Prato Sopa 24
Soup Plate 24
Plato Hondo 24
Assiette Creuse 24
△496 gr A 31 mm C 233 mm CAP. 237 ml
△1 1/8 lbs H 1 3/8" L 9 1/8" CAP. 8 oz



PERLA 21101965
Prato Sobremesa 21
Dessert Plate 21
Plato Postre 21
Assiette à Dessert 21
△378 gr A 18 mm C 209 mm
△8/8 lbs H 3/8" L 8 3/8"



PERLA 21101966
Prato Pão 17
Bread & Butter Plate 17
Plato Pan 17
Assiette à Pain 17
△239 gr A 18 mm C 166 mm
△1/2 lbs H 3/8" L 6 3/8"



PERLA 21101970
Saladeira 23
Salad Bowl 23
Ensaladera 23
Saladier 23
△1036 gr A 75 mm C 230 mm CAP. 2161 ml
△2 3/8 lbs H 3" L 9" CAP. 73 1/2 oz



PERLA 21101983
Châvena Consomé com Pires 26cl
Consomme Cup & Saucer 26cl
Taza Consomé con Platillo 26cl
Tasse et Soucoupe Bouillon 26cl

PERLA 21101982
Châvena Consomé 26cl
Consomme Cup 26cl
Taza Consomé 26cl
Tasse Bouillon 26cl
△256 gr A 55 mm C 143 mm L 100 mm CAP. 257 ml
△4/8 lbs H 2 1/8" L 5 5/8" W 3 3/8" CAP. 8 3/8 oz



PERLA 21108457
Molheira 20cl
Sauceboat 20cl
Salsera 20cl
Saucière 20cl
△209 gr A 77 mm C 128 mm L 73 mm CAP. 218 ml
△4/8 lbs H 3" L 5" W 2 7/8" CAP. 7 3/8 oz



PERLA 21101971
Tigela 12
Bowl 12
Bowl 12
Coupe 12
△338 gr A 63 mm C 123 mm CAP. 431 ml
△3/4 lbs H 2 1/2" L 4 3/8" CAP. 14 1/2 oz

PERLA 21101969
Pires Pequeno Consomé 26cl
Consomé Saucer 26cl
Platillo Consomé 26cl
Soucoupe Bouillon 26cl
△246 gr A 21 mm C 162 mm
△3/8 lbs H 8/8" L 6 3/8"



PERLA 21108001
Leiteira Grande 30cl
Large Creamer 30cl
Lechera Grande 30cl
Crémier Grand Modèle 30cl
△ 269 gr A 96 mm C 112 mm L 66 mm CAP. 297 ml
△ 3/5 lbs H 3 7/8" L 4 2/5" W 2 3/5" CAP. 10 oz



PERLA 21108441
Leiteira Pequena 12,5cl
Small Creamer 12,5cl
Lechera Pequeña 12,5cl
Crémier Petit Modèle 12,5cl
△ 150 gr A 75 mm C 85 mm L 51 mm CAP. 124 ml
△ 1/3 lbs H 3" L 3 1/5" W 2" CAP. 4 1/5 oz



PERLA 21108444
Açucareiro Pacotes
Sugar Box
Azucarero Paquetes
Sucrier Sachets de Sucre
△ 190 gr A 68 mm C 117 mm L 68 mm CAP. 199 ml
△ 3/7 lbs H 2 2/5" L 4 3/5" W 2 3/5" CAP. 6 5/8 oz



PERLA 21108436
Bule Grande 80cl
Large Tea Pot 80cl
Tetera Grande 80cl
Théière Grand Modèle 80cl
△ 798 gr A 145 mm C 219 mm L 109 mm CAP. 926 ml
△ 1 3/4 lbs H 5 5/8" L 8 5/8" W 4 3/8" CAP. 31 1/3 oz



PERLA 21108437
Bule Pequeno 40cl
Small Tea Pot 40cl
Tetera Pequeña 40cl
Théière Petit Modèle 40cl
△ 491 gr A 125 mm C 180 mm L 87 mm CAP. 455 ml
△ 1 1/5 lbs H 4 9/8" L 7 1/8" W 3 3/8" CAP. 15 3/8 oz



PERLA 21108000
Cafeteira Grande 80cl
Large Coffee Pot 80cl
Cafetera Grande 80cl
Cafetière Grand Modèle 80cl
△ 798 gr A 145 mm C 219 mm L 109 mm CAP. 926 ml
△ 1 3/4 lbs H 5 5/8" L 8 5/8" W 4 3/8" CAP. 31 1/3 oz



PERLA 21108439
Cafeteira Pequena 40cl
Small Coffee Pot 40cl
Cafetera Pequeña 40cl
Cafetière Petit Modèle 40cl
△ 491 gr A 125 mm C 180 mm L 87 mm CAP. 455 ml
△ 1 1/5 lbs H 4 9/8" L 7 1/8" W 3 3/8" CAP. 15 3/8 oz



PERLA 21108459
Caneca 40cl
Mug 40 cl
Mug 40 cl
Mug 40cl
△ 334 gr A 111 mm C 125 mm L 97 mm CAP. 396 ml
△ 3/4 lbs H 4 3/8" L 4 9/8" W 3 3/8" CAP. 13 3/8 oz



PERLA 21101981
Chávena Pequeno Almoço com Pires 26cl
Breakfast Cup & Saucer 26 cl
Taza Desayuno con Platillo 26 cl
Tasse et Sous-tasse Petit Déjeuner 26cl

PERLA 21101980
Chávena Pequeno Almoço 26cl
Breakfast Cup 26cl
Taza Desayuno 26cl
Tasse Petit Déjeuner 26cl
△ 268 gr A 67 mm C 114 mm L 89 mm CAP. 263 ml
△ 3/5 lbs H 2 3/8" L 4 1/2" W 3 1/2" CAP. 8 5/8 oz



PERLA 21101979
Chávena Chá com Pires 20cl
Tea Cup & Saucer 20cl
Taza Té con Platillo 20cl
Tasse et Sous-tasse Thé 20cl

PERLA 21101978
Chávena Chá 20cl
Tea Cup 20cl
Taza Té 20cl
Tasse Thé 20cl
△ 219 gr A 63 mm C 108 mm L 82 mm CAP. 206 ml
△ 1/2 lbs H 2 1/2" L 4 1/4" W 3 3/8" CAP. 7 oz

PERLA 21101969
Pires Pequeno Almoço 26cl
Breakfast Saucer 26cl
Platillo Desayuno 26cl
Sous-tasse Petit Déjeuner 26cl
△ 246 gr A 21 mm Ø 162 mm
△ 1/2 lbs H 5/8" Ø 6 3/8"

PERLA 21101968
Pires Chá 20cl
Tea Saucer 20cl
Platillo Té 20cl
Sous-tasse Thé 20cl
△ 220 gr A 21 mm Ø 152 mm
△ 1/2 lbs H 5/8" Ø 6"



PERLA 21101977
Chávena Café com Pires 13cl
Coffee Cup & Saucer 13cl
Taza Café Cortado con Platillo 13cl
Tasse et Sous-tasse Café 13cl

PERLA 21101976
Chávena Café 13cl
Coffee Cup 13cl
Taza Café Cortado 13cl
Tasse Café 13cl
△ 138 gr A 59 mm C 87 mm L 66 mm CAP. 125 ml
△ 3/7 lbs H 2 1/5" L 3 3/5" W 2 3/5" CAP. 4 3/8 oz



PERLA 21101975
Chávena Café com Pires 9cl
Coffee Cup & Saucer 9cl
Taza Café con Platillo 9cl
Tasse et Sous-tasse Café 9cl

PERLA 21101974
Chávena Café 9cl
Coffee Cup 9cl
Taza Café Cortado 9cl
Tasse Café 9cl
△ 122 gr A 50 mm C 87 mm L 66 mm CAP. 101 ml
△ 3/7 lbs H 2" L 3 3/5" W 2 3/5" CAP. 3 3/8 oz

PERLA 21101967
Pires Café 9cl
Coffee Saucer 9cl
Platillo Café Cortado 9cl
Sous-tasse Café 9cl
△ 129 gr A 17 mm Ø 123 mm
△ 3/7 lbs H 3/5" Ø 4 5/8"

PERLA 21101967
Pires Café 9cl
Coffee Saucer 9cl
Platillo Café Cortado 9cl
Sous-tasse Café 9cl
△ 129 gr A 17 mm Ø 123 mm
△ 3/7 lbs H 3/5" Ø 4 5/8"





PERLA 21107999
Chávena Pequeno Almoço com Pires 33cl
Breakfast Cup & Saucer 33cl
Taza Desayuno con Platillo 33cl
Tasse et Sous-tasse Petit Déjeuner 33cl

PERLA 21108454
Chávena Pequeno Almoço 33cl
Breakfast Cup 33cl
Taza Desayuno 33cl
Tasse Petit Déjeuner 33cl
△ 273 gr A 77 mm C 136 mm L 110 mm CAP. 334 ml
△ 3/5 lbs H 3" L 5 3/8" W 4 1/3" CAP. 11 2/3 oz



PERLA 21107998
Chávena Chá com Pires 21cl
Tea Cup & Saucer 21cl
Taza Té con Platillo 21cl
Tasse et Sous-tasse Thé 21cl

PERLA 21108451
Chávena Chá 21cl
Tea Cup 21cl
Taza Té 21cl
Tasse Thé 21cl
△ 192 gr A 65 mm C 117 mm L 95 mm CAP. 210 ml
△ 3/7 lbs H 2 5/8" L 4 3/8" W 3 3/4" CAP. 7 1/6 oz

PERLA 21108456
Pires Pequeno Almoço 33cl
Breakfast Saucer 33cl
Platillo Desayuno 33cl
Sous-tasse Petit Déjeuner 33cl
△ 267 gr A 24 mm Ø 172 mm
△ 3/5 lbs H 1" Ø 6 7/8"

PERLA 21108452
Pires Chá 21cl
Tea Saucer 21cl
Platillo Té 21cl
Sous-tasse Thé 21cl
△ 237 gr A 25 mm Ø 157 mm
△ 1/2 lbs H 1" Ø 6 1/8"



PERLA 21108446
Chávena Café com Pires 13cl
Coffee Cup & Saucer 13cl
Taza Café Cortado con Platillo 13cl
Tasse et Sous-tasse Café 13cl

PERLA 21108445
Chávena Café 13cl
Coffee Cup 13cl
Taza Café Cortado 13cl
Tasse Café 13cl
△ 139 gr A 61 mm C 98 mm L 79 mm CAP. 127 ml
△ 3/7 lbs H 2 3/8" L 3 9/8" W 3 1/8" CAP. 4 3/7 oz



PERLA 21107997
Chávena Café com Pires 9cl
Coffee Cup & Saucer 9cl
Taza Café con Platillo 9cl
Tasse et Sous-tasse Café 9cl

PERLA 21108447
Chávena Café 9cl
Coffee Cup 9cl
Taza Café 9cl
Tasse Café 9cl
△ 108 gr A 63 mm C 81 mm L 63 mm CAP. 84 ml
△ 1/4 lbs H 2 1/2" L 3 1/8" W 2 1/2" CAP. 2 5/6 oz

PERLA 21110260
Pires Café 13cl
Coffee Saucer 13cl
Platillo Café Cortado 13cl
Sous-tasse Café 13cl
△ 195 gr A 24 mm Ø 140 mm
△ 3/7 lbs H 1" Ø 5 1/2"

PERLA 21108449
Pires Café 9cl
Coffee Saucer 9cl
Platillo Café 9cl
Sous-tasse Café 9cl
△ 97 gr A 20 mm Ø 123 mm
△ 3/6 lbs H 7/8" Ø 4 3/8"



PERLA 21108442
Saleiro
Salt
Salero
Salière
△ 83 gr A 79 mm C 53 mm L 52 mm
△ 1/6 lbs H 3 1/8" L 2 1/8" W 2"

PERLA 21108443
Pimenteiro
Pepper
Pimentero
Poivrière
△ 83 gr A 79 mm C 53 mm L 52 mm
△ 1/6 lbs H 3 1/8" L 2 1/8" W 2"





SAGRES

Sagres é um modelo clássico e requintado, com motivos relevados na aba, formando um suave ondulado, evocativo do mar desbravado pelos nossos navegadores. Distinto, o serviço Sagres é a escolha certa para uma refeição serena e para servir um reconfortante chá.

Sagres is a classic and exquisite model with relief motifs on the edges, forming a soft wave evoking the sea, pioneered by our navigators. Sagres is a distinct set and is the right choice for a serene meal and for serving a soothing tea.

Sagres es un modelo clásico y exquisito, con motivos en relieve en el borde, formando una suave ondulación, evocando el mar amansado por nuestros navegadores. Diferente, el conjunto Sagres es la elección adecuada para una comida serena y para servir un reconfortante té.

Sagres est un modèle classique et raffiné, avec des motifs en relief sur les ailes, formant une douce ondulation, évocatrice de la mer qui a ouvert de nouvelles voies à nos navigateurs. Marquant la différence, le service Sagres est le bon choix pour un repas tranquille et pour servir un thé apaisant.





SAGRES PF179001
Travessa Oval Grande 41
Large Oval Platter 41
Fuente Oval Grande 41
Plat à Servir Ovale Grand Modèle 41
△ 1726 gr A 41 mm C 409 mm L 322 mm
△ 3 3/8 lbs H 1 3/8" L 16 1/2" W 12 3/8"



SAGRES PF179019
Travessa Oval Média 34
Medium Oval Platter 34
Fuente Oval Mediana 34
Plat à Servir Ovale Moyen 34
△ 1215 gr A 38 mm C 344 mm L 268 mm
△ 2 3/8 lbs H 1 1/2" L 13 3/8" W 10 3/8"



SAGRES PF179027
Travessa Oval Pequena 29
Small Oval Platter 29
Fuente Oval Pequena 29
Plat à Servir Ovale Petit Modèle 29
△ 757 gr A 33 mm C 296 mm L 233 mm
△ 1 3/8 lbs H 1 1/2" L 11 3/8" W 9 1/8"



SAGRES PF818283
Travessa Redonda Funda 33
Deep Round Plate 33
Fuente Redonda Honda 33
Plat à Servir Creux Rond 33
△ 1229 gr A 43 mm Ø 326 mm
△ 2 5/8 lbs H 1 5/8" Ø 12 5/8"



SAGRES PF195928
Travessa Redonda Rasa 32
Flat Round Plate 32
Fuente Redonda Llana 32
Plat à Servir Rond 32
△ 1291 gr A 48 mm Ø 328 mm
△ 2 5/8 lbs H 1 5/8" Ø 12 5/8"



SAGRES PF820946
Prato Raso 25
Dinner Plate 25
Plato Llano 25
Assiette Plate 25
△ 583 gr A 34 mm Ø 254 mm
△ 1 3/8 lbs H 1 1/2" Ø 10"



SAGRES PF820954
Prato Sopa 22
Soup Plate 22
Plato Hondo 22
Assiette Creuse 22
△ 455 gr A 38 mm Ø 226 mm CAP. 507 ml
△ 1 lbs H 1 1/2" Ø 8 5/8" CAP. 17 1/2 oz



SAGRES PF178896
Prato Sobremesa 21
Dessert Plate 21
Plato Postre 21
Assiette à Dessert 21
△ 431 gr A 25 mm Ø 219 mm
△ 1 lbs H 1" Ø 8 5/8"



SAGRES PF822922
Prato Doce 17
Bread & Butter Plate 17
Plato Pan 17
Petit Assiette à Dessert
△ 235 gr A 21 mm Ø 173 mm
△ 1/2 lbs H 5/8" Ø 6 3/4"



SAGRES PF179132
Prato Salada 22
Salad Plate 22
Plato Ensalada 22
Assiette à Salade 22
△ 351 gr A 23 mm Ø 223 mm
△ 7/8 lbs H 5/8" Ø 8 7/8"



SAGRES PF179043
Conserveira
Olive Dish
Rabanera
Ravier
△ 174 gr A 37 mm Ø 136 mm CAP. 255 ml
△ 3/8 lbs H 1 1/8" Ø 5 3/8" CAP. 8 3/8 oz



SAGRES PF179086
Terrina 232cl
Tureen 232cl
Sopera 232cl
Soupière 232cl
△ 1911 gr A 188 mm C 334 mm L 217 mm CAP. 2318 ml
△ 4 3/8 lbs H 7 3/8" L 13 1/2" W 8 5/8" CAP. 78 3/8 oz



SAGRES PF179078
Saladeira 21
Salad Bowl 21
Ensaladera 21
Saladier 21
△ 769 gr A 86 mm Ø 217 mm CAP. 1699 ml
△ 1 3/8 lbs H 3 3/8" Ø 8 5/8" CAP. 57 3/8 oz



SAGRES PF194468
Châvena Consomé com Pires 30cl
Consomme Cup & Saucer 30cl
Taza Consomé con Platillo 30cl
Tasse et Soucoupe Bouillon 30cl

SAGRES PF179035
Châvena Consomé 30cl
Consomme Cup 30cl
Taza Consomé 30cl
Tasse Bouillon 30cl
△ 183 gr A 51 mm C 159 mm L 121 mm CAP. 301 ml
△ 3/8 lbs H 2" L 6 1/4" W 4 3/4" CAP. 10 1/8 oz

SAGRES PF178918
Pires Consomé 30cl
Consomme Saucer 30cl
Platillo Consomé 30cl
Soucoupe Bouillon 30cl
△ 246 gr A 25 mm Ø 179 mm
△ 3/8 lbs H 1" Ø 7"



SAGRES PF179051
 Molheira com Prato 28cl
 Sauceboat & Stand 28cl
 Salsera con Platillo 28cl
 Saucière avec Soucoupe 28cl

SAGRES PF820377
 Molheira 28cl
 Sauceboat 28cl
 Salsera 28cl
 Saucière 28cl
 △ 312 gr A 93 mm C 222 mm L 95 mm CAP. 287 ml
 △ 3/5 lbs H 3 3/8" L 8 3/4" W 3 3/4" CAP. 9 5/8 oz



SAGRES PF053317
 Tigela Cereais 17
 Cereal Bowl 17
 Taza Cereales 17
 Bol Céréales 17
 △ 261 gr A 47 mm Ø 170 mm CAP. 586 ml
 △ 4/5 lbs H 1 1/2" Ø 6 5/8" CAP. 19 1/2 oz



SAGRES PF179124
 Leiteira 36cl
 Milk Jug 36cl
 Lechera 36cl
 Crémier 36cl
 △ 304 gr A 101 mm C 141 mm L 105 mm CAP. 363 ml
 △ 2/3 lbs H 4" L 5 5/8" W 4 1/8" CAP. 12 2/3 oz



SAGRES PF179094
 Açucareiro
 Sugar Bowl
 Azucarero
 Sucrier
 △ 337 gr A 123 mm C 145 mm L 106 mm CAP. 350 ml
 △ 3/4 lbs H 4 3/8" L 5 3/4" W 4 1/8" CAP. 11 5/8 oz



SAGRES PF179108
 Bule 152cl
 Tea Pot 152cl
 Tetera 152cl
 Théière 152cl
 △ 971 gr A 194 mm C 241 mm L 172 mm CAP. 1524 ml
 △ 2 1/2 lbs H 7 5/8" L 9 1/2" W 6 7/8" CAP. 51 5/8 oz



SAGRES PF179116
 Cafeteira 122cl
 Coffee Pot 122cl
 Cafetera 122cl
 Cafetière 122cl
 △ 740 gr A 208 mm C 213 mm L 146 mm CAP. 1217 ml
 △ 1 5/8 lbs H 8 1/8" L 8 3/8" W 5 3/4" CAP. 41 1/2 oz



SAGRES PF194719
 Chávena Pequeno Almoço com Pires 33cl
 Breakfast Cup & Saucer 33cl
 Taza Desayuno con Platillo 33cl
 Tasse et Sous-tasse Petit Déjeuner 33cl

SAGRES PF178969
 Chávena Pequeno Almoço 33cl
 Breakfast Cup 33cl
 Taza Desayuno 33cl
 Tasse Petit Déjeuner 33cl
 △ 198 gr A 68 mm C 136 mm L 109 mm CAP. 337 ml
 △ 5/8 lbs H 2 3/8" L 5 3/8" W 4 3/4" CAP. 11 3/8 oz



SAGRES PF193305
 Chávena Chá com Pires 21cl
 Tea Cup & Saucer 21cl
 Taza Té con Platillo 21cl
 Tasse et Sous-tasse Thé 21cl

SAGRES PF178977
 Chávena Chá 21cl
 Tea Cup 21cl
 Taza Té 21cl
 Tasse Thé 21cl
 △ 112 gr A 56 mm C 115 mm L 93 mm CAP. 212 ml
 △ 1/4 lbs H 2 1/8" L 4 1/2" W 3 3/8" CAP. 7 1/8 oz

SAGRES PF178926
 Pires Pequeno Almoço 33cl
 Breakfast Saucer 33cl
 Platillo Desayuno 33cl
 Sous-tasse Petit Déjeuner 33cl
 △ 207 gr A 25 mm Ø 170 mm
 △ 5/8 lbs H 1" Ø 6 5/8"

SAGRES PF178934
 Pires Chá 21cl
 Tea Saucer 21cl
 Platillo Té 21cl
 Sous-tasse Thé 21cl
 △ 155 gr A 23 mm Ø 150 mm
 △ 1/3 lbs H 5/8" Ø 5 5/8"



SAGRES PF193313
 Chávena Café com Pires 9cl
 Coffee Cup & Saucer 9cl
 Taza Café con Platillo 9cl
 Tasse et Sous-tasse Café 9cl

SAGRES PF178985
 Chávena Café 9cl
 Coffee Cup 9cl
 Taza Café 9cl
 Tasse Café 9cl
 △ 62 gr A 55 mm C 79 mm L 59 mm CAP. 87 ml
 △ 1/5 lbs H 2 1/8" L 3 1/8" W 2 1/2" CAP. 2 5/8 oz

SAGRES PF178942
 Pires Café 9cl
 Coffee Saucer 9cl
 Platillo Café 9cl
 Sous-tasse Café 9cl
 △ 103 gr A 20 mm Ø 117 mm
 △ 3/8 lbs H 7/8" Ø 4 3/8"





VIRTUAL

A geometria desafiante de Virtual evidencia-se nas diversas e singulares formas que convoca, revelando uma clara vocação contemporânea. O desenho evidencia a funcionalidade, mas as suas nuances estéticas conferem-lhe uma inegável sofisticação.

The provoking geometry of the Virtual emerges from its distinct and unique shapes, revealing a clear contemporary vocation. Its design emphasizes functionality, but its aesthetic nuances give it undeniable sophistication.

La geometría desafiante de Virtual se evidencia en las diversas y singulares formas que convoca, revelando una clara vocación contemporánea. El diseño pone en evidencia la funcionalidad, pero sus matices estéticos le confieren una innegable sofisticación.

La géométrie provoquante de Virtual est soulignée par des formes diverses et uniques qui marquent cette collection, révélant une claire vocation contemporaine. La conception met en évidence la fonctionnalité, mais ses nuances esthétiques lui donnent un raffinement indéniable.





VIRTUAL 21111222
Travessa Rectangular Grande 42
Large Rectangular Platter 42
Fuente Rectangular Grande 42
Plat à Servir Rectangulaire Grand Modèle 42
△ 1896 gr A 33 mm C 424 mm L 294 mm
△ 4 1/8 lbs H 1 3/8" L 16 5/8" W 11 3/8"



VIRTUAL 21111220
Travessa Rectangular Média 34
Medium Rectangular Platter 34
Fuente Rectangular Mediana 34
Plat à Servir Rectangulaire Moyen 34
△ 1139 gr A 28 mm C 344 mm L 238 mm
△ 2 1/2 lbs H 1 1/8" L 13 3/8" W 9 3/8"



VIRTUAL 21111221
Travessa Rectangular Pequena 30
Small Rectangular Platter 30
Fuente Rectangular Pequena 30
Plat à Servir Rectangulaire Petit Modèle 30
△ 829 gr A 31 mm C 302 mm L 210 mm
△ 1 3/8 lbs H 1 3/8" L 11 3/8" W 8 1/4"



VIRTUAL 21111243
Prato Marcador Redondo 32
Round Charger Plate 32
Plato Presentación Redondo 32
Assiette de Présentation Ronde 32
△ 1056 gr A 22 mm Ø 322 mm
△ 2 1/8 lbs H 7/8" Ø 12 3/8"



VIRTUAL 21111242
Prato Raso Redondo 30
Dinner Round Plate 30
Plato Llano Redondo 30
Assiette Plate Ronde 30
△ 944 gr A 25 mm Ø 300 mm
△ 2 1/8 lbs H 1" Ø 11 3/8"



VIRTUAL 21111241
Prato Raso Redondo 28
Dinner Round Plate 28
Plato Llano Redondo 28
Assiette Plate Ronde 28
△ 748 gr A 25 mm Ø 281 mm
△ 1 3/8 lbs H 1" Ø 11 1/8"



VIRTUAL 21111240
Prato Raso Redondo 25
Dinner Round Plate 25
Plato Llano Redondo 25
Assiette Plate Ronde 25
△ 644 gr A 24 mm Ø 251 mm
△ 1 3/8 lbs H 1" Ø 9 7/8"



VIRTUAL 21111244
Prato Pasta Redondo 29
Pasta Round Plate 29
Plato Pasta Redondo 29
Assiette Plate Ronde 29
△ 889 gr A 51 mm Ø 293 mm CAP. 624 ml
△ 2 lbs H 2" Ø 11 5/8" CAP. 21 1/8 oz



VIRTUAL 21111239
Prato Sopa Redondo 25
Round Soup Plate 25
Plato Hondo Redondo 25
Assiette Creuse Ronde 25
△ 631 gr A 39 mm Ø 250 mm CAP. 330 ml
△ 1 3/8 lbs H 1 3/8" Ø 9 3/8" CAP. 11 1/8 oz



VIRTUAL 21111238
Prato Sobremesa Redondo 21
Round Dessert Plate 21
Plato Postre Redondo 21
Assiette à Dessert Ronde 21
△ 435 gr A 24 mm Ø 208 mm
△ 1 lbs H 1" Ø 8 1/8"



VIRTUAL 21111237
Prato Pão Redondo 16
Round Bread & Butter Plate 16
Plato Pan Redondo 16
Assiette à Pain Ronde 16
△ 242 gr A 19 mm Ø 157 mm
△ 3/8 lbs H 3/4" Ø 6 1/8"



VIRTUAL 21111232
Prato Raso Quadrado 28
Square Dinner Plate 28
Plato Llano Cuadrado 28
Assiette Plate Carrée 28
△ 865 gr A 25 mm C 281 mm L 281 mm
△ 1 3/8 lbs H 1" L 11 1/8" W 11 1/8"



VIRTUAL 21111231
Prato Sobremesa Quadrado 21
Square Dessert Plate 21
Plato Postre Cuadrado 21
Assiette à Dessert Carré 21
△ 512 gr A 25 mm C 210 mm L 210 mm
△ 1 1/8 lbs H 1" L 8 1/4" W 8 1/4"



VIRTUAL 21111223
Prato Pão Quadrado 16
Square Bread & Butter Plate 16
Plato Pan Cuadrado 16
Assiette à Pain Carré 16
△ 256 gr A 20 mm C 160 mm L 160 mm
△ 4/8 lbs H 7/8" L 6 3/8" W 6 3/8"



VIRTUAL 21114028
Prato Divisórias 30
Divided Plate 30
Plato Divisorio 30
Plat avec Compartiments 30
△ 1316 gr A 27 mm C 304 mm L 304 mm
△ 2 3/8 lbs H 1 1/8" L 12" W 12"



VIRTUAL 21111236
Saladeira Quadrada 21
Square Salad Bowl 21
Ensaladera Cuadrada 21
Saladier Carré 21
△ 511 gr A 63 mm C 211 mm L 211 mm CAP. 1055 ml
△ 1 1/8 lbs H 2 1/2" L 8 3/8" W 8 3/8" CAP. 35 3/8 oz



VIRTUAL 21111233
Tigela Quadrada 13
Square Bowl 13
Bowl Cuadrada 13
Coupelle Carré 13
△ 171 gr A 42 mm C 129 mm L 129 mm CAP. 254 ml
△ 3/8 lbs H 1 3/8" L 5 1/8" W 5 1/8" CAP. 8 3/8 oz



A close-up photograph of several stacked plates with a light green, textured, scale-like pattern. A silver fork is visible in the upper right corner. The word "DECORATIONS" is overlaid in black, uppercase letters, with a thin orange horizontal line underneath it.

DECORATIONS



ARTVILLE *by Jakè*

Artville by Jakè é pura alegria! Licenciado pela Escola de Artes de Paris, Jakè aproximou o seu trabalho da street art, através de um estilo generoso e espontâneo, criando um universo lexical intenso e contemporâneo, facilmente reconhecível. *Artville* são histórias escondidas e jogos espelhados, onde se multiplicam planos e acumulam símbolos. Rodopios de emoções verdadeiras que saltam das peças para a sua mesa.

Artville by Jakè is an expression of pure happiness! With a degree from the School of Fine Arts, Paris, Jakè brought his work closer to street art, through his spontaneous and sweeping style, creating a world of intense and contemporary expression, easily recognizable. Artville holds hidden stories and mirrored games, where planes are multiplied and symbols come together. Spins on true emotions that jump out of the pieces and onto your table.

Artville by Jakè es pura alegría. Licenciado por la Escuela de Bellas Artes de París, Jakè aproximó su trabajo al arte urbano, recurriendo a un estilo generoso y espontáneo, creando un universo léxico intenso y contemporáneo fácilmente reconocible. Artville son historias escondidas y juegos de espejos, donde se multiplican planos y se acumulan símbolos. Un remolino de emociones verdaderas que saltan de las piezas directamente a su mesa.

Artville by Jakè, la joie en personne! Diplômé de l'école des beaux-arts à Paris, il a rapproché son travail de l'art de rue, à travers un style généreux et spontané, créant un univers lexical intense et contemporain, facilement reconnaissable. Artville, c'est des histoires cachées et des jeux de miroir, où se multiplient les plans et s'accroissent les symboles. Des pièces remplies d'émotions réelles qui s'invitent à votre table.





ARTVILLE 21130243
 Travessa Oval 39x24 Dog
 Oval Platter 39x24 Dog
 Fuente Oval 39x24 Dog
 Plat à Servir Ovale 39x24 Dog
 △ 1182 gr A 24 mm C 393 mm L 245 mm
 △ 2 3/8 lbs H 1" L 15 1/2" W 9 5/8"



ARTVILLE 21130238
 Prato Marcador Redondo 33 Octopus
 Round Charger Plate 33 Octopus
 Plato Presentación Redondo 33 Octopus
 Assiette de Présentation Ronde 33 Octopus
 △ 1121 gr A 21 mm Ø 329 mm
 △ 2 4/8 lbs H 5/8" Ø 13"



ARTVILLE 21130241
 Prato Raso 30 Sayings
 Dinner Plate 30 Sayings
 Plato Llano 30 Sayings
 Assiette Plate 30 Sayings
 △ 888 gr A 27 mm Ø 299 mm
 △ 2 lbs H 1 1/8" Ø 11 7/8"



ARTVILLE 21130242
 Prato Raso Centro Grande 30 Red Roses
 Dinner Plate Large Center 30 Red Roses
 Plato Llano Centro Grande 30 Red Roses
 Assiette Plate Grand Bassin 30 Red Roses
 △ 850 gr A 27 mm Ø 300 mm
 △ 1 7/8 lbs H 1 1/8" Ø 11 3/8"



ARTVILLE 21130244
 Prato Grande 28 Kiss
 Large Plate 28 Kiss
 Plato Grande 28 Kiss
 Assiette Grand Modèle 28 Kiss
 △ 1050 gr A 37 mm Ø 288 mm
 △ 2 1/8 lbs H 1 4/8" Ø 11 1/8"



ARTVILLE 21130245
 Prato Grande 28 Rose
 Large Plate 28 Rose
 Plato Grande 28 Rose
 Assiette Grand Modèle 28 Rose
 △ 1050 gr A 37 mm Ø 288 mm
 △ 2 1/8 lbs H 1 4/8" Ø 11 1/8"



ARTVILLE 21130239
 Prato Aba Larga 30 Little Roses
 Large Rim Plate 30 Little Roses
 Plato Ala Ancha 30 Little Roses
 Assiette Grand Bassin 30 Little Roses
 △ 1004 gr A 24 mm Ø 301 mm
 △ 2 3/8 lbs H 1" Ø 11 5/8"



ARTVILLE 21130240
 Taça Pequena Alta 13 Little Roses
 Small Bowl High 13 Little Roses
 Bowl Pequena Alta 13 Little Roses
 Coupe Petit Modèle Haute 13 Little Roses
 △ 413 gr A 56 mm Ø 134 mm CAP. 284 ml
 △ 9/8 lbs H 2 1/8" Ø 5 3/8" CAP. 9 3/8 oz



AZURE

Azure encontra a sua inspiração na azulejaria portuguesa, quer nos motivos, aos quais é dada uma releitura contemporânea, quer no muito característico lápis-lazúli, resultante do pigmento "ultramarine" da rocha metamórfica com o mesmo nome. Esta cor-rainha da arte cerâmica acentua a frescura e leveza da decoração, que nos transporta para um ambiente marcadamente mediterrânico.

Inspired by Portuguese tiles, the Azure collection features traditional designs, reinterpreted according to contemporary trends, and the deep ultramarine blue for which lapis lazuli is prized. This intense colour, widely used in ceramics, brings out the exquisite, dainty decorative motifs featured, transporting us to an archetypally Mediterranean universe.

Azure encuentra su inspiración en los azulejos portugueses, tanto en los motivos, a los cuales se otorga una relectura contemporánea, como en el característico lapislázuli, resultante del pigmento ultramarino de la roca metamórfica con el mismo nombre. Este color rey del arte cerámico acentúa la frescura y la ligereza de la decoración, que nos transporta a un ambiente marcadamente mediterráneo.

Azure trouve son inspiration dans l'art de l'azulejo portugais, aussi bien au niveau des motifs auxquels est apportée une réinterprétation contemporaine, qu'au niveau du très caractéristique lápis-lazúli, résultat du pigment «ultramarine» de la roche métamorphique du même nom. Cette couleur-reine de l'art céramique accentue la fraîcheur et la légèreté de la décoration qui nous transporte vers une atmosphère pleinement méditerranéenne.





AZURE 21118586
 Travessa Oval Grande 38
Large Oval Platter 38
Fuente Oval Grande 38
Plat à Servir Ovale Grand Modèle 38
 △ 1868 gr A 34 mm C 423 mm L 323 mm
 △ 4 1/8 lbs H 1 1/2" L 16 3/8" W 12 3/4"



AZURE 21118587
 Travessa Oval Média 35
Medium Oval Platter 35
Fuente Oval Mediana 35
Plat à Servir Ovale Moyen 35
 △ 1318 gr A 29 mm C 358 mm L 273 mm
 △ 3 lbs H 1 1/2" L 14" W 10 3/4"



AZURE 21120454
 Travessa Oval 29x18
Oval Platter 29x18
Fuente Oval 29x18
Plat à Servir Ovale 29x18
 △ 605 gr A 25 mm C 288 mm L 177 mm
 △ 1 1/8 lbs H 1" L 11 1/2" W 7"



AZURE 21120453
 Travessa Oval 25x16
Oval Platter 25x16
Fuente Oval 25x16
Plat à Servir Ovale 25x16
 △ 411 gr A 23 mm C 252 mm L 156 mm
 △ 1 lbs H 1" L 10" W 6 1/4"



AZURE 21118583
 Prato Marcador 32
Charger Plate 32
Plato Presentación 32
Assiette à Présentation 32
 △ 1179 gr A 24 mm Ø 319 mm
 △ 2 3/8 lbs H 1" Ø 12 3/8"



AZURE 21118584
 Prato Raso 27
Dinner Plate 27
Plato Llano 27
Assiette Plate 27
 △ 734 gr A 23 mm Ø 269 mm
 △ 1 3/8 lbs H 1" Ø 10 3/8"



AZURE 21125263
 Prato Pasta Pequeno 24
Small Pasta Plate 24
Plato Pasta Pequeño 24
Assiette à Pâtes Petit Modèle 24
 △ 599 gr A 59 mm Ø 244 mm CAP. 458 ml
 △ 1 1/8 lbs H 2 1/8" Ø 9 3/8" CAP. 15 1/2 oz



AZURE 21118588
 Prato Sopa 19
Soup Plate 19
Plato Sopa 19
Assiette Creuse 19
 △ 395 gr A 38 mm Ø 193 mm CAP. 553 ml
 △ 7/8 lbs H 1 1/2" Ø 7 3/8" CAP. 18 2/3 oz



AZURE 21118585
 Prato Sobremesa 21
Dessert Plate 21
Plato Postre 21
Assiette à Dessert 21
 △ 367 gr A 16 mm Ø 210 mm
 △ 4/8 lbs H 3/8" Ø 8 1/4"



AZURE 21128498
 Prato Pão 17
Bread & Butter Plate 17
Plato Pan 17
Assiette à Pain 17
 △ 231 gr A 25 mm Ø 170 mm
 △ 1/2 lbs H 1" Ø 6 3/4"



AZURE 21118591
 Bandeja Redonda com Asas
Round Tray with Handles
Bandeja Redonda con Alas
Plateau Rond avec Poignées
 △ 1177 gr A 34 mm C 375 mm L 334 mm
 △ 2 3/8 lbs H 1 1/2" L 14 3/4" W 13 1/4"



AZURE 21118590
 Bandeja Torta
Tart Tray
Bandeja Torta
Plat à Cake
 △ 637 gr A 19 mm C 394 mm L 152 mm
 △ 1 3/8 lbs H 3/4" L 25 1/2" W 6"



AZURE 21118589
Saladeira Pequena 16
Small Salad Bowl 16
Ensaladera Pequeña 16
Saladier Petit Modèle 16
△ 369 gr A 61 mm Ø 161 mm CAP. 751 ml
△ 1/5 lbs H 2 3/5" Ø 6 1/3" CAP. 25 3/5 oz



AZURE 21120452
Taça Tapas 10
Tapas Bowl 10
Bowl Tapas 10
Coupelle Tapas 10
△ 137 gr A 50 mm Ø 100 mm CAP. 195 ml
△ 1/3 lbs H 2" Ø 4" CAP. 6 3/5 oz



AZURE 21125262
Leiteira Grande 35cl
Large Milk Jug 35cl
Lechera Grande 35cl
Crémier Grand Modèle 35cl
△ 287 gr A 108 mm C 128 mm
L 86 mm CAP. 349 ml
△ 3/8 lbs H 4 1/4" L 5" W 3 3/5" CAP. 11 4/5 oz



AZURE 21125261
Açucareiro
Sugar Bowl
Azucarero
Sucrier
△ 306 gr A 89 mm Ø 95 mm CAP. 246 ml
△ 2/3 lbs H 3 1/2" Ø 3 3/4" CAP. 8 1/3 oz



AZURE 21120990
Bule Grande 90cl
Large Tea Pot 90cl
Tetera Grande 90cl
Théière Grand Modèle 90cl
△ 657 gr A 135 mm C 202 mm L 128 mm
Ø 129 mm CAP. 846 ml
△ 1 4/8 lbs H 5 1/3" L 8"
W 5" Ø 5" CAP. 28 3/5 oz



AZURE 21120451
Bule Pequeno 45cl
Small Tea Pot 45cl
Tetera Pequeña 45cl
Théière Petit Modèle 45cl
△ 965 gr A 113 mm C 170 mm
L 104 mm CAP. 436 ml
△ 2 1/8 lbs H 4 4/8" L 6 2/3"
W 4" CAP. 14 3/4 oz



AZURE 21125260
Chávena Chá com Pires Emp. 22cl
Tea Cup & Saucer St. 22cl
Taza Té con Platillo St. 22cl
Tasse et Sous-tasse Thé Emp. 22cl
△ 447 gr A 62 mm Ø 157 mm CAP. 223 ml
△ 1 lbs H 2 4/8" Ø 6 1/8" CAP. 7 1/2 oz



AZURE 21125259
Chávena Café com Pires Emp. 9cl
Coffee Cup & Saucer St. 9cl
Taza Café con Platillo St. 9cl
Tasse et Sous-tasse Café Emp. 9cl
△ 216 gr A 48 mm Ø 146 mm CAP. 85 ml
△ 1/2 lbs H 1 8/8" Ø 5 3/4" CAP. 2 7/8 oz





CARRARA HOTEL

O encontro entre a porcelana e os desenhos inspirados no nobre mármore Carrara Hotel, numa abordagem geométrica muito refinada, cria a ilusão que cada peça do conjunto pode transformar-se noutra.

La combinación entre porcelana y dibujos inspirados en el mármol de Carrara Hotel, con un refinado enfoque geométrico, crea la ilusión de que cada pieza del conjunto es intercambiable.

The combination between porcelain and drawings inspired by the noble marble of Carrara Hotel, a very refined, geometric approach, creates the illusion that each piece of the set is interchangeable.

La combinaison de la porcelaine et des motifs inspirés par le noble marbre de l'Hôtel Carrara, dans une approche géométrique très raffinée, crée l'illusion que chaque pièce de l'ensemble peut être transformée en une autre.





CARRARA HOTEL 21131040
 Travessa Oval 29x18
 Oval Platter 29x18
 Fuente Oval 29x18
 Plat à Servir Ovale 29x18
 △ 529 gr A 25 mm C 288 mm L 178 mm
 △ 1 1/8 lbs H 1 L 11 1/2" W 7"



CARRARA HOTEL 21131041
 Travessa Oval 25x16
 Oval Platter 25x16
 Fuente Oval 25x16
 Plat à Servir Ovale 25x16
 △ 420 gr A 25 mm C 252 mm L 156 mm
 △ 9/8 lbs H 1 L 9 9/8" W 6 1/4"



CARRARA HOTEL 21131036
 Prato Marcador Redondo 33
 Round Charger Plate 33
 Plato Presentación Redondo 33
 Assiette à Présentation 33
 △ 1170 gr A 23 mm Ø 330 mm
 △ 2 2/8 lbs H 3/8" Ø 13"



CARRARA HOTEL 21131037
 Prato Raso Redondo 28
 Round Dinner Plate 28
 Plato Llano Redondo 28
 Assiette Plate 28
 △ 770 gr A 24 mm Ø 280 mm
 △ 1 5/8 lbs H 1" Ø 11"



CARRARA HOTEL 21133136
 Prato Fundo 27
 Deep Plate 27
 Plato Hondo 27
 Assiette Creuse 27
 △ 748gr A 53 mm Ø 274 mm CAP. 222 ml
 △ 1 1/8 lbs H 2 Ø 10 9/8" CAP. 7 1/2"



CARRARA HOTEL 21131038
 Prato Sobremesa Redondo 22
 Round Dessert Plate 22
 Plato Postre Redondo 22
 Assiette à Dessert 22
 △ 440 gr A 21 mm Ø 220 mm
 △ 1 lbs H 3/8" Ø 8 3/8"



CARRARA HOTEL 21131039
 Prato Pão Redondo 16
 Round Bread & Butter Plate 16
 Plato Pan Redondo 16
 Assiette à Pain 16
 △ 228 gr A 18 mm Ø 162 mm
 △ 1/2 lbs H 3/8" Ø 6 3/8"



CARRARA HOTEL 21131042
 Taça Sopa 14
 Soup Bowl 14cm
 Tazón de Sopa 14
 Bol de Soupe 14cm
 △ 263 gr A 64 mm Ø 140 mm CAP. 541 ml
 △ 2/8 lbs H 2 1/2" Ø 5 1/2" CAP. 18 3/8 oz



CARRARA HOTEL 21131043
 Taça Arroz 11
 Rice Bowl 11cm
 Tazón de Arroz 11
 Bol à Riz 11cm
 △ 198 gr A 65 mm Ø 110 mm CAP. 334 ml
 △ 4/8 lbs H 2 5/8" Ø 4 1/8" CAP. 11 3/8 oz



CARRARA HOTEL 21131046
 Açucareiro
 Sugar Bowl
 Azucarero
 Sucrier
 △ 306 gr A 89 mm C 95 mm CAP. 246 ml
 △ 2/8 lbs H 3 1/2" L 0% CAP. 0% oz



CARRARA HOTEL 21131047
 Bule Grande 90cl
 Large Tea Pot 90cl
 Tetera Grande 90cl
 Thétière Grand Modèle 90cl
 △ 657 gr A 135 mm C 202 mm L 129 mm
 CAP. 846 ml
 △ 1 4/8 lbs H 5 1/8" L 8 W 5 1/8" CAP. 28 3/8 oz



CARRARA HOTEL 21131048
 Bule Pequeno 40cl
 Small Tea Pot 40cl
 Tetera Pequena 40cl
 Thétière Petit -Modèle 40cl
 △ 409 gr A 113 mm C 170 mm L 104 mm
 CAP. 436 ml
 △ 9/8 lbs H 4 9/8" L 6 5/8" W 4 1/8" CAP. 14 3/8 oz



CARRARA HOTEL 21131044
 Leiteira Grande 35cl
 Large Milk Jug 35cl
 Lechera Grande 35cl
 Crémier Grand Modèle 35cl
 △ 300 gr A 102 mm C 58 mm
 △ 2/8 lbs H 4 L 2 3/8"



CARRARA HOTEL 21131045
 Leiteira Pequena 11cl
 Small Milk Jug 11cl
 Lechera Pequena 11cl
 Crémier Petit Modèle 11cl
 △ 215 gr A 92 mm C 50 mm
 △ 1/2 lbs H 3 3/8" L 2"



CARRARA HOTEL 21133223
 Châvena Café Emp. 9cl
 St Coffee Cup 9cl
 Taza Café St 9cl
 Tasse Café Emp. 9cl
 △ 101 gr A 48 mm Ø 60 mm CAP. 85 ml
 △ 3/8 lbs H 1 3/8" Ø 2 mm CAP. 2 7/8 oz



CARRARA HOTEL 21133228
 Châvena Chã Emp. 22cl
 St Tea Cup 22cl
 Taza Té St 22cl
 Tasse Thé Emp. 22cl
 △ 227 gr A 62 mm Ø 85 mm CAP. 223 ml
 △ 1/2 lbs H 2 3/8" Ø 3 CAP. 7 3/8 oz

CARRARA HOTEL 21131049
 Châvena Café com Pires Emp. 9cl
 St. Coffee Cup & Saucer 9cl
 Taza Café c/ Platillo St 9cl
 Tasse et Sous-tasse Café Emp. 22cl
 △ 217 gr A 54 mm C 118 mm L 60 mm
 CAP. 82 ml
 △ 1/2 lbs H 2 1/8" L 4 3/8" W 2 3/8" CAP. 2 7/8 oz

CARRARA HOTEL 21133224
 Pires Café
 St Coffee Saucer 9cl
 Platillo Café St 9cl
 Sous-tasse Café Emp. 9cl
 △ 115 gr A 20 mm Ø 118 mm
 △ 1/4 lbs H 7/8" Ø 4"

CARRARA HOTEL 21131050
 Châvena Chã com Pires Emp. 22cl
 St. Tea Cup & Saucer 22cl
 Taza Té c/ Platillo St 22cl
 Tasse et Sous-tasse Thé Emp. 22cl
 △ 435 gr A 69 mm C 155 mm L 85 mm
 CAP. 223 ml
 △ 1 lbs H 2 3/8" L 6 1/8" W 3 1/8" CAP. 7 3/8 oz

CARRARA HOTEL 21133229
 Pires Chã
 St Tea Saucer 22cl
 Platillo Thé St 22cl
 Sous-tasse Thé Emp. 22cl
 △ 208 gr A 25 mm Ø 115 mm
 △ 4/8 lbs H 1" Ø 6"



MAR HOTEL

Inspirada nas texturas dos corais e das conchas, a linha *Mar Hotel* alia a poesia das profundezas do mar às exigências práticas da vida moderna. A sua capacidade de adaptação faz desta coleção uma excelente escolha para os mais variados ambientes e ocasiões.

Inspired by the textures of corals and shells, the Mar Hotel line combines poetry from the depths of the sea to the practical demands of modern life. Its adaptability to different environments makes it an excellent choice for a variety of occasions.

Inspirada en las texturas de los corales, y de las conchas, la línea Mar Hotel combina, la poesía de las profundidades del mar con las exigencias prácticas de la vida moderna. Su capacidad de adaptación a diversos ambientes hacen de ella una excelente elección para las más diversas ocasiones.

Inspirée des textures des coraux et des coquillages, la ligne Mar («Mer») Hotel combine la poésie des profondeurs aux exigences pratiques de la vie moderne. Son adaptabilité fait de cette collection un excellent choix pour une grande variété d'ambiances et d'occasions.





MAR HOTEL 21130433
Travessa Oval 29
Oval Platter 29
Fuente Oval 29
Plat à Servir Ovale 29
△ 529 gr A 25 mm C 288 mm L 178 mm
△ 1 1/8 lbs H 1" L 11 1/8" W 7"



MAR HOTEL 21130435
Travessa Oval 25
Oval Platter 25
Fuente Oval 25
Plat à Servir Ovale 25
△ 420 gr A 25 mm C 252 mm L 156 mm
△ 9/16 lbs H 1" L 9 7/8" W 6 1/8"

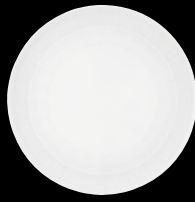

MAR HOTEL 21130428
Prato Marcador Redondo 33
Round Charger Plate 33
Plato Presentación Redondo 33
Assiette de Présentation Ronde 33
△ 1170 gr A 23 mm Ø 330 mm
△ 2 1/2 lbs H 3/8" Ø 13"

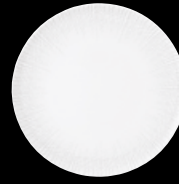

MAR HOTEL 21130430
Prato Raso Redondo 28
Round Dinner Plate 28
Plato Llano Redondo 28
Assiette Plate Ronde 28
△ 770 gr A 24 mm Ø 280 mm
△ 1 5/8 lbs H 1" Ø 11"



MAR HOTEL 21130431
Prato Sobremesa Redondo 22
Round Dessert Plate 22
Plato Postre Redondo 22
Assiette à Dessert Ronde 22
△ 440 gr A 21 mm Ø 220 mm
△ 1 lbs H 5/8" Ø 8 3/8"



MAR HOTEL 21130432
Prato Pão Redondo 16
Round Bread & Butter Plate 16
Plato Pan Redondo 16
Assiette à Pain Ronde 16
△ 228 gr A 18 mm Ø 162 mm
△ 1/2 lbs H 3/8" Ø 6 3/8"



MAR HOTEL 21133083
Prato Fundo 27
Deep Plate 27
Assiette Creuse 27
Assiette Creuse 27
△ 748 gr A 53 mm Ø 274 mm CAP. 222 ml
△ 1 2/3 lbs H 2 1/8" Ø 10 7/8" CAP. 7 1/2 oz



MAR HOTEL 21130443
Taça Sopa 14
Soup Bowl 14
Tazón de Sopa 14
Bol de Soupe 14
△ 263 gr A 64 mm Ø 141 mm CAP. 541 ml
△ 3/4 lbs H 2 1/2" Ø 5 5/8" CAP. 18 2/3 oz



MAR HOTEL 21130444
Taça Arroz 11
Rice Bowl 11
Tazón de Arroz 11
Bol à Riz 11
△ 198 gr A 65 mm Ø 110 mm CAP. 334 ml
△ 4/5 lbs H 2 3/8" Ø 4 1/8" CAP. 11 2/3 oz



MAR HOTEL 21130436
Leiteira Grande 35cl
Large Milk Jug 35cl
Lechera Grande 35cl
Crémier Grand Modèle 35cl
△ 300 gr A 102 mm C 58 mm
△ 2/3 lbs H 4" L 5"



MAR HOTEL 21130437
Leiteira Pequena 11cl
Small Milk Jug 11cl
Lechera Pequeña 11cl
Crémier Petit Modèle 11cl
△ 215 gr A 92 mm C 50 mm
△ 1/2 lbs H 3 3/8" L 2"



MAR HOTEL 21130438
Açucareiro
Sugar Bowl
Azucarero
Sucrier
△ 306 gr A 89 mm Ø 95 mm CAP. 246 ml
△ 2/3 lbs H 3 1/2" Ø 3 3/4" CAP. 8 1/2 oz



MAR HOTEL 21130439
Bule Grande 90cl
Large Tea Pot 90cl
Tetera Grande 90cl
Théière Grand Modèle 90cl
△ 657 gr A 135 mm C 202 mm L 129 mm CAP. 846 ml
△ 1 4/5 lbs H 5 1/8" L 8" W 5" CAP. 28 3/8 oz



MAR HOTEL 21130440
Bule Pequeno 40cl
Small Tea Pot 40cl
Tetera Pequeña 40cl
Théière Petit Modèle 40cl
△ 409 gr A 113 mm C 170 mm L 104 mm CAP. 436 ml
△ 3/4 lbs H 4 3/8" L 6 5/8" W 4 1/8" CAP. 14 3/4 oz



MAR HOTEL 21130442
Chávena Chá com Pires Emp. 22cl
St Tea Cup & Saucer 22cl
Taza Té con Platillo St 22cl
Tasse et Sous-tasse Thé Emp. 22cl
△ 435 gr A 69 mm C 155 mm L 85 mm CAP. 223 ml
△ 1 lbs H 2 3/8" L 6 1/8" W 3 1/8" CAP. 7 3/8 oz

MAR HOTEL 21133232
Chávena Chá 22cl
St Tea Cup 22cl
Taza Té St 22cl
Tasse Thé Emp. 22cl
△ 227 gr A 62 mm Ø 85 mm CAP. 223 ml
△ 1/2 lbs H 2 3/8" Ø 3 1/8" CAP. 7 3/8 oz



MAR HOTEL 21130441
Chávena Café com Pires Emp. 9cl
St. Coffee Cup & Saucer 9cl
Taza Café con Platillo St. 9cl
Tasse et Sous-tasse Café Emp. 9cl
△ 217 gr A 54 mm C 118 mm L 60 mm CAP. 82 ml
△ 1/2 lbs H 2 1/8" L 4 3/8" W 2 3/8" CAP. 2 7/8 oz

MAR HOTEL 21133230
Chávena Café 9cl
St Coffee Cup 9cl
Taza Café St 9cl
Tasse Café Emp. 9cl
△ 101 gr A 48 mm Ø 60 mm CAP. 85 ml
△ 3/8 lbs H 1 3/8" Ø 2 3/8" CAP. 2 7/8 oz

MAR HOTEL 21133231
Pires Café 9cl
St Coffee Saucer 9cl
Platillo Café St 9cl
Sous-tasse Café Emp. 9cl
△ 115 gr A 20 mm Ø 118 mm
△ 1/4 lbs H 7/8" Ø 4 3/8"

MAR HOTEL 21133233
Pires Chá 22cl
St Tea Saucer 22cl
Platillo Thé St 22cl
Sous-tasse Thé Emp. 22cl
△ 208 gr A 25 mm Ø 155 mm
△ 3/8 lbs H 1" Ø 6 1/8"



TILES

A palavra “azulejo” tem origem no árabe azzelij, “pequena pedra polida”, mas também é comumente associada com o termo persa lazward, “lâpis-lázuli”, visto grande parte da produção portuguesa de azulejo usar esta cor. A coleção *Tiles* homenageia essa herança árabe, que se tornaria uma das produções mais originais da cultura portuguesa, com os seus próprios motivos decorativos, geométricos, vegetalistas e muitos outros, ultrapassando a mera função utilitária e instituindo-se como arte. Um serviço prático com um forte sentido cenográfico.

The word “azulejo” [tile] comes from the Arabic “azzelij”, “a small polished stone”, also commonly associated with the Persian term “lazward”, “lapis lazuli”, due to the fact that a great part of the Portuguese tile production uses this colour. Tiles collection pays a tribute to this Arab heritage, which revealed to be one of the most original productions of Portuguese culture, with its own decorative, geometric, vegetal motifs, and many others features, surpassing simple utilitarian function and becoming art.

La palabra azulejo con origen árabe azzelij, que significa pequeña piedra pulida, aunque también se suele asociar al término persa lazward, que significa lapislázuli, por la fuerte presencia de este color en gran parte del azulejo portugués. La colección Tiles presta homenaje a este legado árabe, que se convertirá en una de las producciones artísticas más originales de la cultura portuguesa. La infinidad de motivos decorativos propios, no solo geométricos o vegetales, superando su sencilla función utilitaria y convirtiéndose en arte.

Le mot « azulejo » vient de l'arabe azzelij, « petite pierre polie », mais il est aussi souvent associé au terme persan lazward, « lapis lazuli », étant donné qu'une grande partie de la production portugaise de carreau de faïence utilise cette couleur. La collection Tiles rend hommage à cet héritage arabe, qui allait devenir l'une des productions les plus originales de la culture portugaise, avec ses propres motifs décoratifs, géométriques, végétales et bien d'autres, dépassant la simple fonction utilitaire et s'imposant comme objet d'art.





TILES 21128418
Travessa Oval 29x18
Oval Platter 29x18
Fuente Oval 29x18
Plat à Servir Ovale 29x18
△ 529 gr A 25 mm C 288 mm L 178 mm
△ 1 1/8 lbs H 1" L 11 1/2" W 7"



TILES 21128419
Travessa Oval 25x16
Oval Platter 25x16
Fuente Oval 25x16
Plat à Servir Ovale 25x16
△ 420 gr A 25 mm C 252 mm L 156 mm
△ 8/9 lbs H 1" L 9 5/8" W 6 1/2"

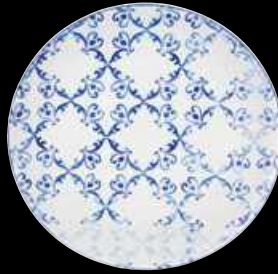

TILES 21128394
Prato Marcador 33
Charger Plate 33
Plato Presentación 33
Assiette de Présentation 33
△ 1170 gr A 23 mm Ø 330 mm
△ 2 2/3 lbs H 5/8" Ø 13"

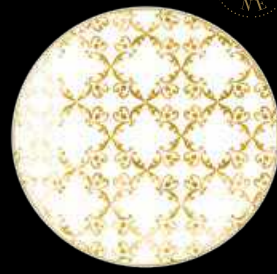

TILES 21135892
Prato Marcador 33
Round Charger Plate 33
Plato Presentación Redondo 33
Assiette de Présentation 33
△ 1170 gr A 23 mm Ø 330 mm
△ 2 2/3 lbs H 1" Ø 13"



TILES 21127529
Prato Raso 28
Dinner Plate 28
Plato Llano 28
Assiette Plate 28
△ 847 gr A 34 mm Ø 300 mm
△ 1 7/8 lbs H 1 1/2" Ø 11 1/2"



TILES 21127530
Prato Raso Redondo 28
Dinner Round Plate 28
Plato Llano Redondo 28
Assiette Plate Ronde 28
△ 770 gr A 24 mm Ø 280 mm
△ 1 3/4 lbs H 1" Ø 11"

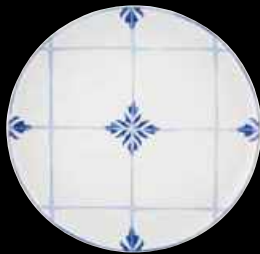

TILES 21128395
Prato Raso Redondo 28
Dinner Round Plate 28
Plato Llano Redondo 28
Assiette Plate Ronde 28
△ 770 gr A 24 mm Ø 280 mm
△ 1 3/4 lbs H 1" Ø 11"

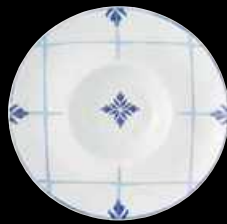

TILES 21127528
Prato Risotto
Risotto Plate
Plato Risotto
Assiette Risotto
△ 748 gr A 53 mm Ø 274 mm CAP: 222 ml
△ 1 2/3 lbs H 2 1/8" Ø 10 7/8" CAP: 7 1/2 oz



TILES 21128897
Prato Sopa Pequeno 24
Small Soup Plate 24
Plato Hondo Pequeno 24
Assiette Creuse Petit Modèle 24
△ 523 gr A 36 mm Ø 240 mm CAP: 288 ml
△ 1 1/4 lbs H 1 3/8" Ø 9 3/8" CAP: 9 3/4 oz



TILES 21128396
Prato Sobremesa Redondo Centro 22
Round Dessert Plate Center 22
Plato Postre Redondo Centro 22
Assiette à Dessert Centre 22
△ 440 gr A 21 mm Ø 220 mm
△ 1 lbs H 5/8" Ø 8 3/8"



TILES 21128397
Prato Sobremesa Redondo 22
Round Dessert Plate 22
Plato Postre Redondo 22
Assiette à Dessert 22
△ 440 gr A 21 mm Ø 220 mm
△ 1 lbs H 5/8" Ø 8 3/8"

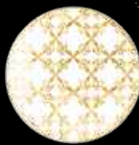

TILES 21135893
Prato Sobremesa Redondo 22
Round Dessert Plate 22
Plato Postre Redondo 22
Assiette à Dessert 22
△ 440 gr A 21 mm Ø 220 mm
△ 1 lbs H 5/8" Ø 8 3/8"



TILES 21128918
Prato Pão Redondo 16
Round Bread & Butter Plate 16
Plato Pan Redondo 16
Assiette à Pain Ronde 16
△ 228 gr A 18 mm Ø 161 mm
△ 1/2 lbs H 3/8" Ø 6 1/8"

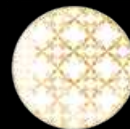

TILES 21135894
Prato Pão Redondo 16
Round Bread & Butter Plate 16
Plato Pan Redondo 16
Assiette à Pain Ronde 16
△ 228 gr A 18 mm Ø 161 mm
△ 1/2 lbs H 3/8" Ø 6 1/8"



TILES 21127531
Prato Pão Mot. A
Bread & Butter Plate Mot. A
Plato Pan Mot. A
Assiette à Pain Mot. A
△ 230 gr A 21 mm Ø 170 mm
△ 1 1/2 lbs H 5/8" Ø 6 5/8"



TILES 21127532
Prato Pão Mot. B
Bread & Butter Plate Mot. B
Plato Pan Mot. B
Assiette à Pain Mot. B
△ 230 gr A 21 mm Ø 170 mm
△ 1 1/2 lbs H 5/8" Ø 6 5/8"



TILES 21127533
Prato Pão Mot. C
Bread & Butter Plate Mot. C
Plato Pan Mot. C
Assiette à Pain Mot. C
△ 230 gr A 21 mm Ø 170 mm
△ 1 1/2 lbs H 5/8" Ø 6 5/8"

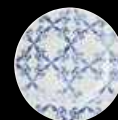

TILES 21127534
Prato Pão Mot. D
Bread & Butter Plate Mot. D
Plato Pan Mot. D
Assiette à Pain Mot. D
△ 230 gr A 21 mm Ø 170 mm
△ 1 1/2 lbs H 5/8" Ø 6 5/8"



TILES 21128421

Taça Sopa 14
Soup Bowl 14
Hondo Bowl 14
Tasse Creuse 14

△ 282 gr A 65 mm Ø 140 mm CAP. 541 ml
△ 3/8 lbs H 2 3/8" Ø 5 1/2" CAP. 18 7/8 oz



TILES 21128420

Taça Arroz 11
Rice Bowl 11
Tazón de Arroz 11
Tasse Riz 11

△ 200 gr A 65 mm Ø 110 mm CAP. 334 ml
△ 3/8 lbs H 2 3/8" Ø 4 1/3" CAP. 11 7/8 oz



TILES 21128422

Chávena Café com Pires Emp. 9cl
St. Coffee Cup & Saucer 9cl
Taza Café con Platillo St. 9cl
Tasse et Sous-tasse Café Emp. 9cl

△ 216 gr A 68 mm Ø 118 mm CAP. 85 ml
△ 1/2 lbs H 2 3/8" Ø 4 5/8" CAP. 2 7/8"

TILES 21133240

Chávena Café Emp. 9cl
St Coffee Cup 9cl
Taza Café St 9cl
Tasse Café Emp. 9cl

△ 101 gr A 48 mm Ø 60 mm CAP. 85 ml
△ 3/8 lbs H 1 3/8" Ø 2 3/8" CAP. 2 7/8 oz



TILES 21128423

Chávena Chá com Pires Emp. 22cl
St. Tea Cup & Saucer 22cl
Taza Té con Platillo St. 22cl
Tasse et Sous-tasse Thé Emp. 22cl

△ 435 gr A 87 mm Ø 155 mm CAP. 223 ml
△ 1 lbs H 3 3/8" Ø 6 1/8" CAP. 7 1/2"

TILES 21133242

Chávena Chá Emp. 22cl
St Tea Cup 22cl
Taza Té St 22cl
Tasse Thé Emp. 22cl

△ 227 gr A 62 mm Ø 85 mm CAP. 223 ml
△ 1/2 lbs H 2 3/8" Ø 3 1/3" CAP. 7 5/8 oz

TILES 21133243

Pires Chá 22cl
St Tea Saucer 22cl
Platillo Thé St 22cl
Sous-tasse Thé Emp. 22cl

△ 208 gr A 25 mm Ø 155 mm
△ 4/8 lbs H 2" Ø 6 1/8"





TRANSATLÂNTICA HOTEL



Transatlântica Hotel é uma obra repleta de simbologia: a caravela representa a descoberta do Brasil; a corneta os festejos do carnaval, com as suas escolas de samba; a estrela, elemento-chave da rosa dos ventos, evoca o mar e o espírito de descoberta; os azulejos refletem a arte e cultura portuguesas. Em Transatlântica Hotel encontramos dois países unidos pelo oceano que os separa.

Transatlântica Hotel is a work full of symbolism: the caravel represents the discovery of Brazil; the bugle from the Carnival festivities and its samba schools; the star, a key element of the compass, evokes the sea and the spirit of discovery; the tiles reflect the Portuguese art and culture. In "Transatlântica" we find two countries united by the ocean that separates them.

Transatlântica Hotel es una obra repleta de simbología: la carabela representa el descubrimiento de Brasil; la bocina las fiestas del carnaval, con sus escuelas de samba; la estrella, elemento clave de la rosa de los vientos, evoca el mar y el espíritu de descubrimiento; los azulejos reflejan el arte y la cultura portuguesa. En Transatlântica encontramos dos países unidos por el océano que los separa.

Transatlântica Hotel est une oeuvre pleine de symbolique: la caravelle représente la découverte du Brésil; la trompette les festivités du carnaval, avec ses écoles de samba; l'étoile, un élément clé de la rose des vents, évoque la mer et l'esprit de découverte; les azulejos reflètent l'art et la culture portugaises. Dans Transatlântica, on retrouve deux pays unis par l'océan qui les sépare.





TRANSATLÂNTICA HOTEL
21131025
Travessa Oval Média 29
Medium Oval Platter 29
Fuente Oval Mediana 29
Plat à Servir Ovale Moyen 29
△ 529 gr A 25 mm C 288 mm L 178 mm
△ 1 1/6 lbs H 1" L 11 1/8" W 7"

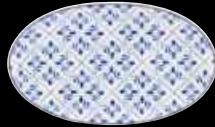

TRANSATLÂNTICA HOTEL
21131026
Travessa Oval Pequena 25
Small Oval Platter 25
Fuente Oval Pequeña 25
Plat à Servir Ovale Petit Modèle 25
△ 420 gr A 25 mm C 252 mm L 156 mm
△ 3/8 lbs H 1" L 9 9/16" W 6 1/2"



TRANSATLÂNTICA HOTEL
21131021
Prato Marcador Redondo 33
Round Charger Plate 33
Plato Presentación Redondo 33
△ 1170 gr A 23 mm Ø 330 mm
△ 2 1/2 lbs H 3/8" Ø 13"

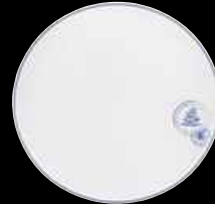

TRANSATLÂNTICA HOTEL
21131022
Prato Raso Redondo 28
Dinner Round Plate 28
Plato Llano Redondo 28
Assiette Plate Ronde 28
△ 770 gr A 24 mm Ø 280 mm
△ 1 3/4 lbs H 1" Ø 11"



TRANSATLÂNTICA HOTEL
21133137
Prato Fundo 27
Deep Plate 27
Plato Hondo 27
Assiette Creuse 27
△ 748 gr A 53 mm Ø 274 mm CAP. 222 ml
△ 1 1/2 lbs H 2" Ø 10 3/8" CAP. 7 1/2"



TRANSATLÂNTICA HOTEL
21131023
Prato Sobremesa Redondo 22
Round Dessert Plate 22
Plato Postre Redondo 22
Assiette à Dessert 22
△ 440 gr A 21 mm Ø 220 mm
△ 1 lbs H 3/8" Ø 8 3/8"



TRANSATLÂNTICA HOTEL
21131024
Prato Pão Redondo 16
Round Bread & Butter Plate 16
Plato Pan Redondo 16
Assiette à Pain Ronde 16
△ 228 gr A 18 mm Ø 162 mm
△ 1/2 lbs H 3/8" Ø 6 3/8"



TRANSATLÂNTICA HOTEL
21131027
Taça Sopa 14
Soup Bowl 14
Hondo Bowl 14
Tasse Creuse 14
△ 263 gr A 64 mm Ø 141 mm CAP. 541 ml
△ 3/4 lbs H 2 1/2" Ø 5 3/8" CAP. 18 3/4"



TRANSATLÂNTICA HOTEL
21131028
Tazón de Arroz 11
Rice Bowl 11
Tazón de Arroz 11
Tasse Riz 11
△ 198 gr A 65 mm Ø 110 mm CAP. 334 ml
△ 3/8 lbs H 2 3/8" Ø 4 1/8" CAP. 11 3/4"



TRANSATLÂNTICA HOTEL
21131029
Leiteira Grande 35cl
Large Milk Jug 35cl
Lechera Grande 35cl
Crémier Grand Modèle 35cl
△ 300 gr A 102 mm C 58 mm
△ 3/8 lbs H 4" L 2 3/8"



TRANSATLÂNTICA HOTEL
21131030
Leiteira Pequena 11cl
Small Milk Jug 11cl
Lechera Pequeña 11cl
Crémier Petit Modèle 11cl
△ 215 gr A 92 mm C 50 mm
△ 1/2 lbs H 3 5/8" L 2"



TRANSATLÂNTICA HOTEL
21131031
Açucareiro
Sugar Bowl
Azucarero
Sucrier
△ 306 gr A 89 mm C 95 mm CAP. 246 ml
△ 3/8 lbs H 3 1/2" L 3 3/4" CAP. 8 1/8" oz



TRANSATLÂNTICA HOTEL
21131032
Bule Grande 90cl
Large Tea Pot 90cl
Tetera Grande 90cl
Théière Grand Modèle 90cl
△ 657 gr A 135 mm C 202 mm L 129 mm CAP. 846 ml
△ 1 1/2 lbs H 5 1/8" L 8" W 5 1/8" CAP. 28 3/8" oz



TRANSATLÂNTICA HOTEL
21131033
Bule Pequeno 40cl
Small Tea Pot 40cl
Tetera Pequeña 40cl
Théière Petit Modèle 40cl
△ 409 gr A 113 mm C 170 mm L 104 mm CAP. 436 ml
△ 3/8 lbs H 4 1/8" L 6 3/8" W 4 1/8" CAP. 14 3/4" oz

TRANSATLÂNTICA HOTEL 21133246

Chávana Chá Emp. 22cl
St Tea Cup 22cl
Taza Té St 22cl
Tasse Thé Emp. 22cl
△ 227 gr A 62 mm Ø 85 mm CAP. 223 ml
△ 3/8 lbs H 2 3/8" Ø 3 1/8" CAP. 7 3/8"



TRANSATLÂNTICA HOTEL 21131035
Chávana Chá com Pires Emp. 22cl
St Tea Cup & Saucer 22cl
Taza Té con Platillo St 22cl
Tasse et Sous-tasse Thé Emp. 22cl
△ 435 gr A 69 mm C 155 mm L 85 mm CAP. 223 ml
△ 1 lbs H 2 3/8" L 6 1/8" W 3 1/8" CAP. 7 3/8" oz

TRANSATLÂNTICA HOTEL 21133247
Pires Chá 22cl
St Tea Saucer 22cl
Platillo Thé St 22cl
Sous-tasse Thé Emp. 22cl
△ 208 gr A 25 mm Ø 155 mm
△ 3/8 lbs H 1" Ø 6 1/8"



TRANSATLÂNTICA HOTEL 21131034
Chávana Café com Pires Emp. 9cl
St Coffee Cup & Saucer 9cl
Taza Café con Platillo St 9cl
Tasse et Sous-tasse Café Emp. 9cl
△ 217 gr A 54 mm C 188 mm L 60 mm CAP. 82 ml
△ 1/2 lbs H 2 1/8" L 4 3/8" W 2 3/8" CAP. 2 7/8" oz

TRANSATLÂNTICA HOTEL 21133244

Chávana Café Emp. 9cl
St Coffee Cup 9cl
Taza Café St 9cl
Tasse Café Emp. 9cl
△ 101 gr A 48 mm Ø 60 mm CAP. 85 ml
△ 3/8 lbs H 1 3/8" Ø 2 3/8" CAP. 2 7/8"

TRANSATLÂNTICA HOTEL 21133245
Pires Café 9cl
St Coffee Saucer 9cl
Platillo Café St 9cl
Sous-tasse Café Emp. 9cl
△ 115 gr A 20 mm Ø 118 mm
△ 1/4 lbs H 7/8" Ø 4 3/8"



TRASSO HOTEL

Trasso Hotel caracteriza-se por linhas arquitetônicas com motivos geométricos, que conferem a toda a coleção um caráter distintivo. A influência de diversas culturas, em particular da oriental, associada à sofisticação das linhas de tableware ocidentais, permite desfrutar de momentos de grande relaxamento e convivialidade.

Trasso Hotel is characterised by architectural lines with geometric patterns, endowing the entire collection with a distinctive appearance. The influence of various cultures, in particular those oriental, associated to the sophistication of western tableware lines, will allow you to enjoy moments of great relaxation and sociability.

Trasso Hotel se caracteriza por líneas arquitectónicas con motivos geométricos, que le dan a toda la colección un carácter distintivo. La influencia de diversas culturas, en particular de la oriental, asociada a la sofisticación de las líneas de tableware occidentales, le permitirá disfrutar de momentos de gran relax y convivencia.

Trasso Hotel se caractérise par des lignes architecturales aux motifs géométriques, qui donnent à cette collection un caractère distinctif. L'influence de différentes cultures, notamment l'orientale, associée à la sophistication des lignes de vaisselle de table occidentales, permet de profiter de moments de grande détente et de convivialité.





TRASSO HOTEL 21131055
Travessa Oval Média 29
Medium Oval Platter 29
Fuente Oval Mediana 29
Plat à Servir Ovale Moyen 29
△ 529 gr A 25 mm C 288 mm L 178 mm
△ 1 1/8 lbs H 1" L 11 1/8" W 7"



TRASSO HOTEL 21131056
Travessa Oval Pequena 25
Small Oval Platter 25
Fuente Oval Pequena 25
Plat à Servir Ovale Petit Modèle 25
△ 420 gr A 25 mm C 252 mm L 156 mm
△ 9/8 lbs H 1" L 9 7/8" W 6 1/8"

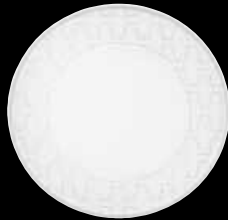

TRASSO HOTEL 21131051
Prato Marcador Redondo 33
Round Charger Plate 33
Plato Presentación Redondo 33
Assiette à Presentación 33
△ 1170 gr A 23 mm Ø 330 mm
△ 2 1/2 lbs H 9/8" Ø 13"

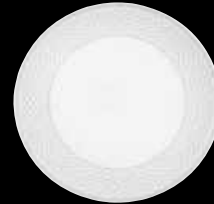

TRASSO HOTEL 21131052
Prato Raso Redondo 28
Dinner Round Plate 28
Plato Llano Redondo 28
Assiette Plate Ronde 28
△ 770 gr A 24 mm Ø 280 mm
△ 1 5/8 lbs H 1" Ø 11"



TRASSO HOTEL 21131053
Prato Sobremesa Redondo 22
Round Dessert Plate 22
Plato Postre Redondo 22
Assiette à Dessert 22
△ 440 gr A 21 mm Ø 220 mm
△ 1 lbs H 5/8" Ø 8 3/8"



TRASSO HOTEL 21133082
Prato Fundo 27
Deep Plate 27
Assiette Creuse 27
Assiette Creuse 27
△ 748 gr A 53 mm Ø 274 mm CAP. 222 ml
△ 1 3/8 lbs H 2 1/8" Ø 10 7/8" CAP. 7 1/2 oz



TRASSO HOTEL 21131054
Prato Pão Redondo 16
Round Bread & Butter Plate 16
Plato Pan Redondo 16
Assiette à Pain Ronde 16
△ 228 gr A 18 mm Ø 162 mm
△ 1/2 lbs H 5/8" Ø 6 3/8"



TRASSO HOTEL 21131057
Taça Sopa 14
Soup Bowl 14
Hondo Bowl 14
Tasse Creuse 14
△ 263 gr A 64 mm Ø 141 mm CAP. 541 ml
△ 9/8 lbs H 2 1/2" Ø 5 5/8" CAP. 18 3/4"



TRASSO HOTEL 21131058
Taça Arroz 11
Rice Bowl 11
Tazón de Arroz 11
Tasse Riz 11
△ 198 gr A 65 mm Ø 110 mm CAP. 334 ml
△ 4/8 lbs H 2 5/8" Ø 4 1/8" CAP. 11 3/8"



TRASSO HOTEL 21131059
Leiteira Grande 35cl
Large Milk Jug 35cl
Lechera Grande 35cl
Crémier Grand Modèle 35cl
△ 300 gr A 102 mm C 58 mm
△ 2/3 lbs H 4" L 2 3/4"



TRASSO HOTEL 21131060
Leiteira Pequena 11cl
Small Milk Jug 11cl
Lechera Pequena 11cl
Crémier Petit Modèle 11cl
△ 215 gr A 92 mm C 50 mm
△ 1/2 lbs H 3 3/8" L 2"



TRASSO HOTEL 21131061
Açucareiro
Sugar Bowl
Azucarero
Sucrier
△ 306 gr A 89 mm C 95 mm CAP. 246 ml
△ 2/3 lbs H 3 1/2" L 3 3/4" CAP. 8 1/2 oz



TRASSO HOTEL 21131062
Bule Grande 90cl
Large Tea Pot 90cl
Tetera Grande 90cl
Théière Grand Modèle 90cl
△ 657 gr A 135 mm C 202 mm L 129 mm CAP. 846 ml
△ 1 4/8 lbs H 5 1/8" L 8" W 5 1/8" CAP. 28 3/8 oz



TRASSO HOTEL 21131063
Bule Pequeno 40cl
Small Tea Pot 40cl
Tetera Pequena 40cl
Théière Petit Modèle 40cl
△ 409 gr A 113 mm C 170 mm L 104 mm CAP. 436 ml
△ 9/8 lbs H 4 3/8" L 6 3/8" W 4 1/8" CAP. 14 3/4 oz



TRASSO HOTEL 21131065
Chávena Chã com Pires Emp. 22cl
St Tea Cup & Saucer 22cl
Taza Té con Platillo St 22cl
Tasse et Sous-tasse Thé Emp. 22cl
△ 435 gr A 69 mm C 155 mm L 85 mm CAP. 223 ml
△ 1 lbs H 2 3/8" L 6 1/8" W 3 1/8" CAP. 7 9/8 oz

TRASSO HOTEL 21133250
Chávena Chã Emp. 22cl
St Tea Cup 22cl
Taza Té St 22cl
Tasse Thé Emp. 22cl
△ 227 gr A 62 mm Ø 85 mm CAP. 223 ml
△ 1/2 lbs H 2 4/8" Ø 3 1/8" CAP. 7 5/8"



TRASSO HOTEL 21131064
Chávena Café com Pires Emp. 9cl
St Coffee Cup & Saucer 9cl
Taza Café con Platillo St 9cl
Tasse et Sous-tasse Café Emp. 9cl
△ 217 gr A 54 mm C 188 mm L 60 mm CAP. 82 ml
△ 1/2 lbs H 2 1/8" L 4 3/8" W 2 3/8" CAP. 2 7/8 oz

TRASSO HOTEL 21133248
Chávena Café Emp. 9cl
St Coffee Cup 9cl
Taza Café St 9cl
Tasse Café Emp. 9cl
△ 101 gr A 48 mm Ø 60 mm CAP. 85 ml
△ 3/8 lbs H 1 3/8" Ø 2 3/8" CAP. 2 7/8"

TRASSO HOTEL 21133249
Pires Café 9cl
St Coffee Saucer 9cl
Platillo Café St 9cl
Sous-tasse Café Emp. 9cl
△ 115 gr A 20 mm Ø 118 mm
△ 1/4 lbs H 7/8" Ø 4 5/8"



VENEZIA HOTEL

A sofisticação das formas e da decoração contrastam com a delicadeza do relevo, finalizando com um toque de cor em degradê. Contemporaneidade prática para restaurantes e hotéis com pormenores de elegância e distinção.

The sophistication of the forms and decoration contrast with the delicacy of the relief, finished with a touch of colour in dégradé. Everyday modernity with details of elegance and distinction.

La sofisticación de las formas e de la decoración, contrasta con la delicadeza del relieve, finalizando con un toque de color en degradé. Contemporaneidad del día a día con detalles de elegancia y distinción.

La sophistication de la forme et de la décoration contraste avec la délicatesse du relief, finalisé par une touche de couleur en dégradé. Une contemporanéité pratique avec des détails élégants et distingués.





VENEZIA HOTEL 21130462
Travessa Oval 29
Oval Platter 29
Fuente Oval 29
Plat à Servir Ovale 29
△ 529 gr A 25 mm C 288 mm L 178 mm
△ 1 1/8 lbs H 1" L 11 1/8" W 7"



VENEZIA HOTEL 21130463
Travessa Oval 25
Oval Platter 25
Fuente Oval 25
Plat à Servir Ovale 25
△ 420 gr A 25 mm C 252 mm L 156 mm
△ 9/8 lbs H 1" L 9 7/8" W 6 1/2"



VENEZIA HOTEL 21130458
Prato Marcador Redondo 33
Round Charger Plate 33
Plato Presentación Redondo 33
Assiette de Présentation Ronde 33
△ 1170 gr A 23 mm Ø 330 mm
△ 2 1/2 lbs H 3/8" Ø 13"



VENEZIA HOTEL 21130459
Prato Raso Redondo 28
Round Dinner Plate 28
Plato Llano Redondo 28
Assiette Plate Ronde 28
△ 770 gr A 24 mm Ø 280 mm
△ 1 5/8 lbs H 1" Ø 11"



VENEZIA HOTEL 21130460
Prato Sobremesa Redondo 22
Round Dessert Plate 22
Plato Postre Redondo 22
Assiette à Dessert Ronde 22
△ 440 gr A 21 mm Ø 220 mm
△ 1 lbs H 5/8" Ø 8 3/4"



VENEZIA HOTEL 21130461
Prato Pão Redondo 16
Round Bread & Butter Plate 16
Plato Pan Redondo 16
Assiette à Pain Ronde 16
△ 228 gr A 18 mm Ø 162 mm
△ 1/2 lbs H 3/8" Ø 6 3/8"



VENEZIA HOTEL 21133081
Prato Fundo 27
Deep Plate 27
Plato Hondo 27
Assiette Creuse 27
△ 748 gr A 53 mm Ø 274 mm CAP. 222 ml
△ 1 2/3 lbs H 2 1/8" Ø 10 7/8" CAP. 7 1/2 oz



VENEZIA HOTEL 21130471
Taça Sopa 14
Soup Bowl 14
Tazón de Sopa 14
Bol de Soupe 14
△ 263 gr A 64 mm Ø 141 mm CAP. 541 ml
△ 7/8 lbs H 2 1/2" Ø 5 5/8" CAP. 18 2/3 oz



VENEZIA HOTEL 21130472
Taça Arroz 11
Rice Bowl 11
Tazón de Arroz 11
Bol à Riz 11
△ 198 gr A 65 mm Ø 110 mm CAP. 334 ml
△ 4/5 lbs H 2 5/8" Ø 4 1/8" CAP. 11 2/3 oz



VENEZIA HOTEL 21130464
Leiteira Grande 35cl
Large Milk Jug 35cl
Lechera Grande 35cl
Crémier Grand Modèle 35cl
△ 300 gr A 102 mm C 58 mm
△ 2/3 lbs H 4" L 5"



VENEZIA HOTEL 21130465
Leiteira Pequena 11cl
Small Milk Jug 11cl
Lechera Pequeña 11cl
Crémier Petit Modèle 11cl
△ 215 gr A 92 mm C 50 mm
△ 1/2 lbs H 3 5/8" L 2"



VENEZIA HOTEL 21130466
Açucareiro
Sugar Bowl
Azucarero
Sucrier
△ 306 gr A 89 mm Ø 95 mm CAP. 246 ml
△ 2/3 lbs H 3 1/2" Ø 3 3/4" CAP. 8 1/2 oz



VENEZIA HOTEL 21130467
Bule Grande 90cl
Large Tea Pot 90cl
Tetera Grande 90cl
Théière Grand Modèle 90cl
△ 657 gr A 135 mm C 202 mm L 129 mm CAP. 846 ml
△ 1 4/5 lbs H 5 1/8" L 8" W 5" CAP. 28 3/8 oz



VENEZIA HOTEL 21130468
Bule Pequeno 40cl
Small Tea Pot 40cl
Tetera Pequeña 40cl
Théière Petit Modèle 40cl
△ 409 gr A 113 mm C 170 mm L 104 mm CAP. 436 ml
△ 3/5 lbs H 4 1/8" L 6 5/8" W 4 1/8" CAP. 14 3/4 oz



VENEZIA HOTEL 21133254
Châvena Chã Emp. 22cl
St. Tea Cup 22cl
Taza Té St 22cl
Tasse Thé Emp. 22cl
△ 227 gr A 62 mm Ø 85 mm CAP. 223 ml
△ 1/2 lbs H 2 1/8" Ø 3 1/8" CAP. 7 5/8 oz



VENEZIA HOTEL 21133255
Pires Chã 22cl
St. Tea Saucer 22cl
Platillo Thé St 22cl
Sous-tasse Thé Emp. 22cl
△ 208 gr A 25 mm Ø 155 mm
△ 4/5 lbs H 1" Ø 6 1/8"

VENEZIA HOTEL 21130470
Châvena Chã com Pires Emp. 22cl
St. Tea Cup & Saucer 22cl
Taza Té con Platillo St 22cl
Tasse et Sous-tasse Thé Emp. 22cl
△ 435 gr A 69 mm C 155 mm L 85 mm CAP. 223 ml
△ 1 lbs H 2 5/8" L 6 1/8" W 3 1/8" CAP. 7 5/8 oz

VENEZIA HOTEL 21130469
Châvena Café com Pires Emp. 9cl
St. Coffee Cup & Saucer 9cl
Taza Café con Platillo St. 9cl
Tasse et Sous-tasse Café Emp. 9cl
△ 217 gr A 54 mm C 118 mm L 60 mm CAP. 82 ml
△ 1/2 lbs H 2 1/8" L 4 5/8" W 2 3/8" CAP. 2 7/8 oz

VENEZIA HOTEL 21133252
Châvena Café Emp. 9cl
St. Coffee Cup 9cl
Taza Café St 9cl
Tasse Café Emp. 9cl
△ 101 gr A 48 mm Ø 60 mm CAP. 85 ml
△ 3/5 lbs H 1 3/8" Ø 2 3/8" CAP. 2 7/8 oz

VENEZIA HOTEL 21133253
Pires Café 9cl
St. Coffee Saucer 9cl
Platillo Café St 9cl
Sous-tasse Café Emp. 9cl
△ 115 gr A 20 mm Ø 118 mm
△ 1/4 lbs H 7/8" Ø 4 5/8"



CONTEMPORARY





ACCESSORIES





COCKTAIL 21132700
Prato Cocktail 27
Cocktail Plate 27
Plato Cocktail 27
Assiette Cocktail 27
△ 491 gr A 26 mm C 280 mm L 185 mm
△ 1 lbs H 1" L 11" W 7 3/4"



COMPLEMENTS 21135388
Bandeja 6 Divisórias
Tray 6 Compartments
Fuente 6 Divisorias
Plateau 6 Compartiments
△ 950 gr A 30 mm C 270 mm L 210 mm
△ 2 lbs H 1 1/8" L 10 3/8" W 8 1/4"



COMPLEMENTS 21135902
Prato Pizza 32
Pizza Plate 32
Plato Pizza 32
Assiette Pizza 32
△ 1030 gr A 19 mm Ø 320 mm
△ 2 1/4 lbs H 3/4" Ø 12 3/8"



COMPLEMENTS 21120865
Prato Degustação Azeite
Olive Oil Tasting Dish
Plato Degustación Aceite Oliva
Assiette Dégustation Huile d'Olive
△ 275 gr A 36 mm Ø 154 mm
△ 3/8 lbs H 1 3/7" Ø 6"



COMPLEMENTS 21123920
Prato Risotto
Risotto Plate
Plato Risotto
Assiette Risotto
△ 748 gr A 53 mm Ø 274 mm CAP. 222 ml
△ 1 3/5 lbs H 2 1/8" Ø 10 7/8" CAP. 7 1/2 oz

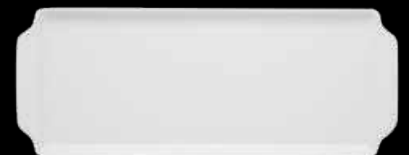

COMPLEMENTS 21123921
Pack 6 Prato Risotto
Pack 6 Risotto Plate
Pack 6 Plato Risotto
Pack 6 Assiette Risotto
△ 4488 gr A 125 mm Ø 274 mm CAP. 222 ml
△ 9 9/16 lbs H 4 9/16" Ø 10 7/8" CAP. 7 1/2 oz

COMPLEMENTS 21000636
Bandeja Torta
Tart Tray
Bandeja Torta
Plat à Cake
△ 637 gr A 19 mm C 394 mm L 152 mm
△ 1 2/5 lbs H 3/4" L 37" W 6"



ASIA

A cultura asiática é conhecida pela sua profunda ligação à natureza e pela forma como essa influência se manifesta no design. Desenhos orgânicos, subtis e inventivos, pensados ao pormenor para cumprir cada função, dão origem a objetos que apetece ver e manusear. Asia captura essa personalidade sensorial e sem tempo, sendo ideal tanto para conceitos de fusão como para abordagens mais tradicionais.

Asian culture is known for its deep connection to nature and the way such influence comes through in design. Thoughtfully conceived to serve each purpose, these organic, subtle and ingenious designs result in objects you want to look at and handle. Asia captures this sensory and timeless nature, and is ideal for fusion concepts and more traditional approaches alike.

La cultura asiática es conocida por su profunda conexión con la naturaleza y la forma en que esta influencia se manifiesta en el diseño. Diseños orgánicos, sutiles y creativos, diseñados en detalle para cumplir cada función, dan lugar a objetos que se quieren ver y manosear. Asia capta esta personalidad sensorial y atemporal, por lo que es ideal tanto para conceptos de fusión como para enfoques más tradicionales.

La culture asiatique est connue pour son lien profond avec la nature et pour la façon dont cette influence se manifeste dans le design. Des dessins organiques, simples et inventifs, pensés dans le moindre détail pour remplir chaque fonction, font naître des objets que l'on a envie de regarder et de manipuler. Asia capte cette personnalité sensorielle et intemporelle, laquelle est idéale pour les concepts de fusion comme pour les approches plus classiques.





ASIA 21134677
Garrafa Sake
Sake Bottle
Botella Sake
Bouteille à Sake
 △ 227 gr A 136 mm C 67 mm L 67 mm
 △ ½ lbs H 5 ½" L 2 ¾" W 2 ¾"



ASIA 21134708
Garrafa Sake Black
Sake Bottle Black
Botella Sake Black
Bouteille à Sake Black
 △ 227 gr A 136 mm C 67 mm L 67 mm
 △ ½ lbs H 5 ½" L 2 ¾" W 2 ¾"



ASIA 21134688
Pousa Pauzinhos
Spoon & Chopstick Rest
Posa Palillos & Cuchara
Repose Baguettes & Cuillère
 △ 20 gr A 80 mm C 82 mm L 35 mm
 △ 2 lbs H 1" L 12 ¾" W 9 ¾"



ASIA 21134713
Pousa Pauzinhos Black
Spoon & Chopstick Rest Black
Posa Palillos & Cuchara Black
Repose Baguettes & Cuillère Black
 △ 20 gr A 80 mm C 82 mm L 35 mm
 △ 2 lbs H 1" L 12 ¾" W 9 ¾"



ASIA 21134680
Tampa Tigela
Bowl Lid
Tapa Bowl
Bol Cloche
 △ 140 gr A 37 mm Ø 110 mm
 △ ½ lbs H 1 ½" Ø 4 ½"



ASIA 21134679
Jarro Soja
Soy Sauce Pitcher
Jarra Soja
Pitchet Soja
 △ 140 gr A 84 mm C 95 mm L 73 mm
 △ ½ lbs H 3 ½" L 3 ¾" W 2 ¾"



ASIA 21134710
Jarro Soja Black
Soy Sauce Pitcher Black
Jarra Soja Black
Pitchet Soja Black
 △ 140 gr A 84 mm C 95 mm L 73 mm
 △ ½ lbs H 3 ½" L 3 ¾" W 2 ¾"



ASIA 21134678
Copo Sake
Sake Cup
Vaso Sake
Verre à Sake
 △ 40 gr A 40 mm Ø 50 mm
 △ 1 ½ lbs H 1" L 1 ½" Ø 2"



ASIA 21134709
Copo Sake Black
Sake Cup Black
Vaso Sake Black
Verre à Sake Black
 △ 40 gr A 40 mm Ø 50 mm
 △ 1 ½ lbs H 1" L 1 ½" Ø 2"



ASIA 21134681
Bule 1L
Tea Pot 1L
Tetera 1L
Théière 1L
 △ 680 gr A 115 mm C 210 mm L 183 mm
 △ 1 ½ lbs H 4 ½" L 8 ¼" W 7 ½"



ASIA 21134686
Colher
Spoon
Cuchara
Cuillère
 △ 45 gr A 56 mm C 150 mm L 40 mm
 △ 2 lbs H 1" L 12 ¾" W 9 ¾"



ASIA 21134687
Suporte Colher
Spoon Holder
Soporte Cuchara
Support Cuillère
 △ 30 gr A 13 mm C 80 mm L 47 mm
 △ 2 lbs H 1" L 12 ¾" W 9 ¾"



ASIA 21134711
Colher Black
Spoon Black
Cuchara Black
Cuillère Black
 △ 45 gr A 56 mm C 150 mm L 40 mm
 △ 2 lbs H 1" L 12 ¾" W 9 ¾"



ASIA 21134712
Suporte Colher Black
Spoon Holder Black
Soporte Cuchara Black
Support Cuillère Black
 △ 30 gr A 13 mm C 80 mm L 47 mm
 △ 2 lbs H 1" L 12 ¾" W 9 ¾"



ASIA 21134683
Prato Divisórias Especial 34
Divided Plate Special 34
Plato Divisorias Especial 34
Plat Avec Compartiments 34
 △ 1520 gr A 24 mm Ø 340 mm
 △ 3 ½ lbs H 1" Ø 21 ¾"



ASIA 21134682
Tigela Wok
Wok Bowl 25
Bowl Wok 25
Bol Wok 25
 △ 730 gr A 66 mm Ø 250 mm
 △ 1 ¾ lbs H 2 ¾" Ø 9 ¾"



ASIA 21134684
Bandeja 2 Divisórias
Tray 2 Compartments
Fuente 2 Divisorias
Plateau 2 Compartiments
 △ 225 gr A 23 mm C 189 mm L 88 mm
 △ ½ lbs H 1" L 7 ¾" W 3 ½"



ASIA 21134685
Bandeja 3 Divisórias
Tray 3 Compartments
Fuente 3 Divisorias
Plateau 3 Compartiments
 △ 225 gr A 23 mm C 189 mm L 88 mm
 △ ½ lbs H 1" L 7 ¾" W 3 ½"



BROADWAY

A sua mesa é o palco de uma encenação elegante e intemporal. Seja qual for a ocasião, o serviço *Broadway* estará à altura. Um toque de contemporaneidade com a marca intemporal do melhor design.

Your table is the stage for an elegant and timeless performance. Whatever the occasion, the Broadway table set will give you a standing ovation. A touch of modernity with the timelessness of the best design.

Su mesa será el escenario de una escenografía elegante e intemporal. Sea cual sea el momento, la vajilla Broadway estará a la altura de la ocasión. Un toque de contemporaneidad con la marca intemporal del mejor diseño.

L'art de la table mis à votre service pour une élégance intemporelle. Pour une soirée à deux, un repas d'affaire, un événement familial, Broadway sera toujours à la hauteur. Une touche contemporaine avec la marque intemporelle du meilleur design.





BROADWAY 21085911
 Travessa Oval Grande 38
Large Oval Platter 38
Fuente Oval Grande 38
Plat à Servir Ovale Grand Modèle 38
 △1363 gr A 28 mm C 384 mm L 294 mm
 △3 lbs H 1 1/8" L 15 1/8" W 11 3/4"



BROADWAY 21085912
 Travessa Oval Média 35
Medium Oval Platter 35
Fuente Oval Mediana 35
Plat à Servir Ovale Moyen 35
 △1318 gr A 29 mm C 358 mm L 273 mm
 △2 3/8 lbs H 1 1/8" L 14 1/8" W 10 3/4"



BROADWAY 21085913
 Travessa Oval Pequena 32
Small Oval Platter 32
Fuente Oval Pequeña 32
Plat à Servir Ovale Petit Modèle 32
 △907 gr A 26 mm C 326 mm L 248 mm
 △2 lbs H 1" L 12 5/8" W 9 3/4"



BROADWAY 21085573
 Prato Marcador 33
Charger Plate 33
Plato Presentación 33
Assiette de Présentation 33
 △1241 gr A 33 mm Ø 330 mm
 △2 3/4 lbs H 1 1/8" Ø 13"



BROADWAY 21085576
 Prato Raso 28
Dinner Plate 28
Plato Llano 28
Assiette Plate 28
 △729 gr A 32 mm Ø 278 mm
 △1 3/8 lbs H 1 1/4" Ø 11"



BROADWAY 21093675
 Prato Pasta Grande 32
Large Pasta Plate 32
Plato Pasta Grande 32
Assiette à Pâtes Grand Modèle 32
 △1160 gr A 70 mm Ø 320 mm CAP. 962 ml
 △2 5/8 lbs H 2 3/4" Ø 12 3/8" CAP. 32 5/8 oz



BROADWAY 21121346
 Prato Pasta Médio 28
Medium Pasta Plate 28
Plato Pasta Mediano 28
Assiette à Pâtes Moyen 28
 △794 gr A 69 mm Ø 280 mm CAP. 636 ml
 △1 3/4 lbs H 2 3/8" Ø 11" CAP. 21 1/2 oz



BROADWAY 21093673
 Prato Pasta Pequeno 24
Small Pasta Plate 24
Plato Pasta Pequeño 24
Assiette à Pâtes Petit Modèle 24
 △599 gr A 59 mm Ø 244 mm CAP. 458 ml
 △1 1/8 lbs H 2 1/8" Ø 9 3/8" CAP. 15 1/2 oz



BROADWAY 21085574
 Prato Sopa 19
Soup Plate 19
Plato Sopa 19
Assiette Creuse 19
 △395 gr A 38 mm Ø 193 mm CAP. 553 ml
 △7/8 lbs H 1 1/2" Ø 7 3/8" CAP. 18 3/8 oz



BROADWAY 21085575
 Prato Sobremesa 23
Dessert Plate 23
Plato Postre 23
Assiette à Dessert 23
 △482 gr A 29 mm Ø 232 mm
 △1 1/8 lbs H 1 1/8" Ø 9 1/8"



BROADWAY 21085951
 Prato Doce 20
Bread & Butter Plate 20
Plato Pan 20
Petit Assiette à Dessert 20
 △310 gr A 21 mm Ø 197 mm
 △2/3 lbs H 3/8" Ø 7 3/4"



BROADWAY 21085916
 Conserveira
Olive Dish
Rabanera
Ravier
 △210 gr A 27 mm C 189 mm L 132 mm
 △3/8 lbs H 1 1/8" L 7 4/8" W 5 1/8"



BROADWAY 21085918
 Terrina 313cl
Tureen 313cl
Sopera 313cl
Soupière 313cl
 △2216 gr A 208 mm C 319 mm L 196 mm CAP. 3128 ml
 △4 3/8 lbs H 8 1/8" L 12 3/8" W 7 7/8" CAP. 105 7/8 oz



BROADWAY 21085910
 Saladeira 25
Salad Bowl 25
Ensaladera 25
Saladier 25
 △1334 gr A 107 mm Ø 250 mm CAP. 3195 ml
 △2 3/8 lbs H 4 3/8" Ø 9 9/8" CAP. 108 oz



BROADWAY 21085924
 Châvena Consomé com Pires 39cl
Consomme Cup & Saucer 39cl
Taza Consomé con Platillo 39cl
Tasse et Soucoupe Bouillon 39cl

BROADWAY 21096270
 Châvena Consomé 39cl
Consomme Cup 39cl
Taza Consomé 39cl
Tasse Bouillon 39cl
 △216 gr A 52 mm C 162 mm L 126 mm CAP. 388 ml
 △1/2 lbs H 2" L 6 3/8" W 5" CAP. 13 1/8 oz

BROADWAY 21096271
 Pires Consomé 39cl
Consomme Saucer 39cl
Platillo Consomé 39cl
Soucoupe Bouillon 39cl
 △232 gr A 23 mm Ø 167 mm
 △1/2 lbs H 3/8" Ø 6 4/8"



BROADWAY 21085917
 Molheira com Prato 36cl
 Sauceboat & Stand 36cl
 Salsera con Platillo 36cl
 Saucière avec Soucoupe 36cl
 △ 538 gr A 74 mm C 190 mm L 134 mm CAP. 362 ml
 △ 1 1/8 lbs H 2 7/8" L 7 1/2" W 5 3/4" CAP. 12 1/4 oz



BROADWAY 21085914
 Tigela Individual 13
 Individual Bowl 13
 Bowl 13
 Bol Individuel 13
 △ 291 gr A 60 mm Ø 129 mm CAP. 449 ml
 △ 3/8 lbs H 2 3/8" Ø 5" CAP. 15 1/2 oz



BROADWAY 21085909
 Leiteira 23cl
 Milk Jug 23cl
 Lechera 23cl
 Crémier 23cl
 △ 218 gr A 104 mm C 122 mm L 62 mm CAP. 234 ml
 △ 1/2 lbs H 4 1/8" L 4 7/8" W 2 3/8" CAP. 7 7/8 oz



BROADWAY 21085907
 Açucareiro
 Sugar Bowl
 Azucarero
 Sucrier
 △ 272 gr A 108 mm C 110 mm L 81 mm CAP. 252 ml
 △ 3/8 lbs H 4 1/4" L 4 1/8" W 3 1/8" CAP. 8 1/2 oz



BROADWAY 21085908
 Bule 90cl
 Tea Pot 90cl
 Tetera 90cl
 Thêière 90cl
 △ 693 gr A 154 mm C 251 mm L 119 mm CAP. 967 ml
 △ 1 3/8 lbs H 6 1/8" L 9 7/8" W 4 3/8" CAP. 32 3/4 oz



BROADWAY 21085915
 Cafeteira 100cl
 Coffee Pot 100cl
 Cafetera 100cl
 Cafetiêre 100cl
 △ 707 gr A 231 mm C 189 mm L 89 mm CAP. 1017 ml
 △ 1 5/8 lbs H 9 1/8" L 7 4/8" W 3 1/2" CAP. 34 2/6 oz



BROADWAY 21087824
 Caneca 32cl
 Mug 32cl
 Mug 32cl
 Mug 32cl
 △ 241 gr A 95 mm C 110 mm L 85 mm CAP. 317 ml
 △ 3/8 lbs H 3 3/4" L 4 1/8" W 3 1/8" CAP. 10 3/4 oz



BROADWAY 21085923
 Châvena Pequeno Almoço com Pires 35cl
 Breakfast Cup & Saucer 35cl
 Taza Desayuno con Platillo 35cl
 Tasse et Sous-tasse Petit Déjeuner 35cl

BROADWAY 21096272
 Châvena Pequeno Almoço 35cl
 Breakfast Cup 35cl
 Taza Desayuno 35cl
 Tasse Petit Déjeuner 35cl
 △ 217 gr A 62 mm C 133 mm L 108 mm CAP. 351 ml
 △ 1/2 lbs H 2 3/8" L 5 1/4" W 4 1/4" CAP. 11 7/8 oz



BROADWAY 21090400
 Châvena Chá 24cl
 Tea Cup 24cl
 Taza Té 24cl
 Tasse Thê 24cl
 △ 185 gr A 57 mm C 118 mm L 97 mm CAP. 241 ml
 △ 3/8 lbs H 2 1/4" L 4 3/8" W 3 3/8" CAP. 8 1/2 oz

BROADWAY 21096271
 Pires Pequeno Almoço 35cl
 Breakfast Saucer 35cl
 Platillo Desayuno 35cl
 Sous-tasse Petit Déjeuner 35cl
 △ 232 gr A 23 mm Ø 167 mm
 △ 1/2 lbs H 1" Ø 6 7/8"

BROADWAY 21085920
 Châvena Chá com Pires 24cl
 Tea Cup & Saucer 24cl
 Taza Té con Platillo 24cl
 Tasse et Sous-tasse Thê 24cl

BROADWAY 21091215
 Pires Chá 24cl
 Tea Saucer 24cl
 Platillo Té 24cl
 Sous-tasse Thê 24cl
 △ 198 gr A 22 mm Ø 157 mm
 △ 3/8 lbs H 7/8" Ø 6 1/8"



BROADWAY 21085919
 Châvena Café com Pires 8cl
 Coffee Cup & Saucer 8cl
 Taza Café con Platillo 8cl
 Tasse et Sous-tasse Café 8cl

BROADWAY 21096268
 Châvena Café 8cl
 Coffee Cup 8cl
 Taza Café 8cl
 Tasse Café 8cl
 △ 84 gr A 62 mm C 71 mm L 51 mm CAP. 78 ml
 △ 1/8 lbs H 2 3/8" L 2 3/8" W 2" CAP. 2 3/8 oz

BROADWAY 21096269
 Pires Café 8cl
 Coffee Saucer 8cl
 Platillo Café 8cl
 Sous-tasse Café 8cl
 △ 105 gr A 18 mm Ø 112 mm
 △ 3/8 lbs H 3/4" Ø 4 3/8"





BUFFET

A coleção *Buffet* da Vista Alegre estabelece um novo padrão criativo na apresentação gastronómica. Uma gama versátil de formas e tamanhos que vai ao encontro dos requisitos para apresentações de buffet, múltiplas ou individuais. Formas de uma elegância escultural na mais pura porcelana, robusta e prática, com um soberbo design.

The Vista Alegre Buffet collection sets a new standard in culinary presentation creativity. A versatile range of shapes and sizes that meets all the requirements of buffet presentations, multiple or individual. Shapes of sculptural elegance made from the purest porcelain, robust, practical and with superb design.

La colección Buffet de Vista Alegre establece un nuevo patrón creativo en la presentación gastronómica. Una gama versátil de formas y tamaños que corresponde a los requisitos para presentaciones de buffet, múltiples o individuales. Formas de una elegancia escultural en la más pura porcelana, robusta y práctica, con un diseño soberbio.

La collection Buffet de Vista Alegre marque un nouveau standard créatif dans la présentation culinaire. Une gamme variée de formes et de tailles qui répond aux exigences inhérentes aux présentations d'un buffet, individuelles ou multiples. Des formes d'une élégance sculpturale en porcelaine pure, résistante et pratique, avec un superbe design.





BUFFET 21107668
Prato Raso 33x25
Dinner Plate 33x25
Plato Llano 33x25
Assiette Plate 33x25
△ 1393 gr A 28 mm C 332 mm L 257 mm
△ 3 lbs H 1 1/8" L 13" W 10 1/8"



BUFFET 21103254
Bandeja Rectangular 39x30
Rectangular Tray 39x30
Fuente Rectangular 39x30
Plateau Rectangulaire 39x30
△ 2017 gr A 28 mm C 397 mm L 305 mm
△ 4 4/9 lbs H 1 1/8" L 15 5/8" W 12"



BUFFET 21103257
Bandeja Rectangular 50x15
Rectangular Tray 50x15
Fuente Rectangular 50x15
Plateau Rectangulaire 50x15
△ 1312 gr A 28 mm C 508 mm L 152 mm
△ 2 8/9 lbs H 1 1/8" L 20" W 6"



BUFFET 21103256
Bandeja Rectangular Funda 50x12
Deep Rectangular Tray 50x12
Fuente Rectangular Honda 50x12
Plateau Rectangulaire Creux 50x12
△ 1367 gr A 51 mm C 510 mm L 124 mm CAP. 832 ml
△ 3 lbs H 2" L 20" W 4 7/8" CAP. 28 1/8 oz



BUFFET 21103255
Bandeja Rectangular Funda 35x8
Deep Rectangular Tray 35x8
Fuente Rectangular Honda 35x8
Plateau Rectangulaire Creux 35x8
△ 606 gr A 36 mm C 355 mm L 88 mm CAP. 313 ml
△ 1 1/3 lbs H 1 3/8" L 14" W 3 1/2" CAP. 10 3/8 oz



BUFFET 21103251
Terrina 1,5L
Tureen 1,5L
Sopera 1,5L
Soupière
△ 1924 gr A 190 mm C 274 mm
L 208 mm CAP. 1562 ml
△ 4 1/4 lbs H 7 1/2" L 10 1/8" W 8 1/8" CAP. 52 4/5 oz



BUFFET 21103253
Saladeira Quadrada Grande 37
Large Square Salad Bowl 37
Ensaladera Cuadrada Grande 37
Saladier Carré Grand Modèle 37
△ 1820 gr A 117 mm C 337 mm
L 337 mm CAP. 3655 ml
△ 4 lbs H 4 3/8" L 13 1/4" W 13 1/4" CAP. 123 3/5 oz



BUFFET 21103252
Saladeira Quadrada Pequena 27
Small Square Salad Bowl 27
Ensaladera Cuadrada Pequeña 27
Saladier Carré Petit Modèle 27
△ 936 gr A 88 mm C 244 mm L 244 mm CAP. 1330 ml
△ 2 lbs H 3 1/2" L 9 3/8" W 9 3/8" CAP. 45 oz



BUFFET 21103260
Saladeira Grande 34
Large Salad Bowl 34
Ensaladera Grande 34
Saladier Grand Modèle 34
△ 1511 gr A 113 mm C 356 mm
L 223 mm CAP. 2311 ml
△ 3 1/3 lbs H 4 4/8" L 14" W 8 7/8" CAP. 78 1/2 oz



BUFFET 21103259
Saladeira Média 28
Medium Salad Bowl 28
Ensaladera Mediana 28
Saladier Moyen 28
△ 977 gr A 92 mm C 286 mm L 185 mm CAP. 1262 ml
△ 2 1/6 lbs H 3 5/8" L 11 1/4" W 7 3/8" CAP. 42 2/3 oz



BUFFET 21103258
Saladeira Pequena 22
Small Salad Bowl 22
Ensaladera Pequeña 22
Saladier Petit Modèle 22
△ 538 gr A 76 mm C 222 mm L 148 mm CAP. 533 ml
△ 1 1/5 lbs H 3" L 8 3/4" W 5 3/8" CAP. 18 oz



BUFFET 21115156
Centro Mesa Wave
Centrepiece Wave
Centro Mesa Wave
Centre de Table Wave
△ 2116 gr A 110 mm Ø 376 mm Cap. 4900 ml
△ 4 2/3 lbs H 4 1/8" Ø 14 1/8" Cap. 165 2/3 oz



BUFFET 21103263
Tigela 19
Bowl 19
Bowl 19
Coupelle 19
△ 460 gr A 69 mm C 194 mm L 141 mm CAP. 467 ml
△ 1 lbs H 2 5/8" L 7 3/8" W 5 3/8" CAP. 15 4/5 oz



BUFFET 21103262
Tigela 16
Bowl 16
Bowl 16
Coupelle 16
△ 304 gr A 59 mm C 163 mm L 119 mm CAP. 265 ml
△ 2/3 lbs H 2 1/2" L 6 3/8" W 4 3/8" CAP. 9 oz



BUFFET 21103261
Tigela 13
Bowl 13
Bowl 13
Coupelle 13
△ 182 gr A 48 mm C 132 mm L 97 mm CAP. 148 ml
△ 2/5 lbs H 1 9/8" L 5 3/8" W 3 3/8" CAP. 5 oz



CARRÉ

Carré é um modelo elegante em porcelana, de inspiração asiática. Distingue-se pela forma quadrada, uma alternativa prática e atrativa aos pratos convencionais redondos. Todas as peças possuem curvas suaves, beiras e esquinas bem definidas. A variedade de formas e tamanhos permite criar inúmeras combinações de grande elegância. Esta versatilidade torna *Carré*, serviço criado pela equipa de design da Vista Alegre, ideal para a apresentação de todos os tipos de cozinha moderna e internacional.

Carré is a stylish, Asian-inspired model in porcelain. It stands out by its square shape, an attractive and practical alternative to conventional round plates. All pieces have smooth curves and finely crafted borders and corners. The variety of shapes and sizes allows you to create endless combinations of outstanding elegance. Carré's versatility makes this table set, created by Vista Alegre's design team, ideal for presentation in all kinds of modern and international cuisine.

Carré es un modelo de porcelana, elegante y de inspiración asiática. Se distingue por su forma cuadrada, una alternativa práctica y atractiva a los convencionales platos redondos. Todas las piezas tienen curvas suaves con bordes y esquinas bien definidos. La variedad de formas y tamaños permite crear numerosas combinaciones de gran elegancia. Esta versatilidad hace de Carré, la vajilla creada por el equipo de diseño de Vista Alegre, la opción ideal para presentar todo tipo de cocina moderna e internacional.

Carré est un modèle élégant en porcelaine, d'inspiration asiatique. Cette collection se distingue par sa forme carrée, une alternative attrayante et pratique aux assiettes rondes classiques. Toutes les pièces ont des courbes lisses, des ailes et des coins bien définis. La variété de formes et de tailles vous permet de créer de nombreuses combinaisons d'une grande élégance. Carré, un service créé par l'équipe de design de Vista Alegre, est très polyvalent et l'idéal pour la présentation de tous les types de cuisine moderne et internationale.



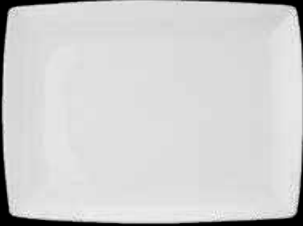

CARRÉ 21090488
Travessa Rectangular Grande 38
Rectangular Platter 38
Fuente Rectangular 38
Plat à Servir Rectangulaire Grand Modèle 38
△1513 gr A 27 mm C 387 mm L 286 mm
△3 1/8 lbs H 1 1/8" L 15 1/4" W 11 1/4"

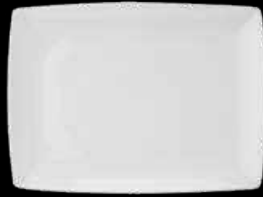

CARRÉ 21094114
Travessa Rectangular Média 32
Rectangular Platter 32
Fuente Rectangular 32
Plat à Servir Rectangulaire Petit Modèle 32
△857 gr A 28 mm C 317 mm L 201 mm
△1 9/16 lbs H 1 1/8" L 12 1/2" W 7 7/8"



CARRÉ 21083882
Prato Marcador 31
Charger Plate 31
Plato Presentacion 31
Assiette à Présentation 31
△1442 gr A 31 mm C 308 mm L 313 mm
△3 1/8 lbs H 1 3/8" L 12 1/8" W 12 1/8"



CARRÉ 21083883
Prato Raso 26
Dinner Plate 26
Plato Llano 26
Assiette Plate 26
△889 gr A 28 mm C 266 mm L 266 mm
△2 lbs H 1 1/8" L 10 1/2" W 10 1/2"



CARRÉ 21129089
Prato Fundo 18
Deep Plate 18
Plato Hondo 18
Plat Creux 18
△252 gr A 28 mm C 185 mm L 110 mm
△5/8 lbs H 1 1/8" L 7 7/8" W 4 1/8"



CARRÉ 21129090
Prato Raso Rectangular 21
Rectangular Dinner Plate 21
Plato Llano Rectangular 21
Assiette Rectangulaire Peu Profond 21
△264 gr A 16 mm C 210 mm L 117 mm
△4/8 lbs H 5/8" L 8 1/4" W 4 3/8"



CARRÉ 21083886
Prato Rectangular Grande 27
Large Rectangular Plate 27
Plato Rectangular Grande 27
Assiette Rectangulaire Grand Modèle 27
△777 gr A 30 mm C 274 mm L 191 mm
△1 5/8 lbs H 1 1/8" L 10 7/8" W 7 1/2"

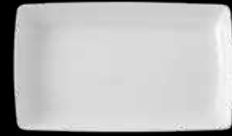

CARRÉ 21098407
Prato Rectangular Pequeno 21
Small Rectangular Plate 21
Plato Rectangular Pequeño 21
Assiette Rectangulaire Petit Modèle 21
△397 gr A 30 mm C 212 mm L 129 mm
△7/8 lbs H 1 1/8" L 8 1/2" W 5 1/8"



CARRÉ 21085627
Prato Sopa 19
Soup Plate 19
Plato Hondo 19
Assiette Creuse 19
△568 gr A 45 mm C 191 mm L 191 mm CAP. 789 ml
△1 1/4 lbs H 1 7/8" L 7 1/2" W 7 1/2" CAP. 26 2/3 oz



CARRÉ 21083884
Prato Sobremesa 21
Dessert Plate 21
Plato Postre 21
Assiette à Dessert 21
△544 gr A 26 mm C 212 mm L 212 mm
△1 1/8 lbs H 1" L 8 1/8" W 8 1/8"



CARRÉ 21090672
Prato Doce 17
Bread & Butter Plate 17
Plato Pan 17
Petit Assiette à Dessert 17
△315 gr A 24 mm C 164 mm L 164 mm
△5/8 lbs H 1" L 6 5/8" W 6 5/8"



CARRÉ 21100715
Prato Quente 16
Hot Dish 16
Plato Caliente 16
Assiette Chauffante 16
△268 gr A 27 mm C 159 mm L 159 mm
△3/8 lbs H 1" L 6 1/4" W 6 1/4"



CARRÉ 21098406
Prato Quadrado 13
Square Plate 13
Plato Cuadrado 13
Assiette Carrée 13
△197 gr A 28 mm C 129 mm L 129 mm
△3/8 lbs H 1 1/8" L 5 1/8" W 5 1/8"



CARRÉ 21094115
Prato Manteiga 9
Butter Plate 9
Plato Mantequilla 9
Assiette à Beurre 9
△91 gr A 20 mm C 94 mm L 94 mm
△1/8 lbs H 7/8" L 3 5/8" W 3 5/8"



CARRÉ 21094088
Bandeja Baguete 32
Baguete Tray 32
Fuente Baguete 32
Plat Baguettes 32
△643 gr A 30 mm C 325 mm L 146 mm
△1 3/8 lbs H 1 1/8" L 12 5/8" W 5 3/4"



CARRÉ 21090487
Bandeja Rectangular 19
Rectangular Tray 19
Fuente Rectangular 19
Plateau Rectangulaire 19
△209 gr A 25 mm C 190 mm L 89 mm
△3/8 lbs H 1" L 7 1/2" W 3 1/2"

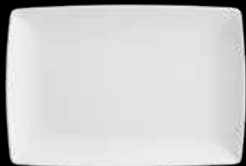

CARRÉ 21125422
Bandeja 22
Tray 22
Fuente 22
Plateau 22
△ 461 gr A 27 mm C 222 mm L 150 mm
△ 1 lbs H 1" L 8 3/4" W 6"



CARRÉ 21083885
Saladeira 22
Salad Bowl 22
Ensaladera 22
Saladier 22
△ 885 gr A 67 mm C 218 mm L 218 mm CAP. 1628 ml
△ 2 lbs H 2 5/8" L 8 4/8" W 8 4/8" CAP. 55 oz



CARRÉ 21098408
Prato Degustação Azeite
Olive Oil Tasting Dish
Plato Degustación Aceite Oliva
Assiette Dégustation Huile D'Olive
△ 157 gr A 25 mm C 106 mm L 106 mm
△ 1/3 lbs H 1" L 4 1/8" W 4 1/8"



CARRÉ 21098405
Colher Degustação
Tasting Spoon
Cuchara Degustación
Cuillère Dégustation
△ 51 gr A 70 mm C 139 mm L 43 mm
△ 1/6 lbs H 2 3/4" L 5 1/2" W 1 5/8"



CARRÉ 21094112
Châvena Consomé com Pires 32cl
Consomme Cup & Saucer 32cl
Taza Consomé con Platillo 32cl
Tasse et Soucoupe Bouillon 32cl

CARRÉ 21094113
Châvena Consomé 32cl
Consomme Cup 32cl
Taza Consomé 32cl
Tasse Bouillon 32cl
△ 260 gr A 62 mm C 163 mm L 109 mm CAP. 323 ml
△ 1/2 lbs H 2 1/8" L 6 3/8" W 4 3/8" CAP. 10 5/8 oz



CARRÉ 21103825
Molheira com Prato 41cl
Sauceboat & Stand 41cl
Salsera con Platillo 41cl
Saucière avec Soucoupe 41cl
△ 249 gr A 77 mm C 129 mm L 106 mm CAP. 412 ml
△ 5/8 lbs H 3" L 5 1/8" W 4 1/8" CAP. 13 5/8 oz

CARRÉ 21091820
Pires Consomé 32cl
Consomme Saucer 32cl
Platillo Consomé 32cl
Soucoupe Bouillon 32cl
△ 291 gr A 24 mm C 149 mm L 149 mm
△ 3/8 lbs H 1" L 5 7/8" W 5 7/8"



CARRÉ 21094116
Taça Sushi Quadrada 9
Square Sushi Bowl 9
Taza Sushi Cuadrada 9
Coupelle Sushi Carré 9
△ 115 gr A 36 mm C 86 mm L 86 mm CAP. 125 ml
△ 1/4 lbs H 1 3/8" L 3 3/8" W 3 3/8" CAP. 4 3/8 oz



CARRÉ 38001755
Taça Sushi Quadrada 9
Square Sushi Bowl 9
Taza Sushi Cuadrada 9
Coupelle Sushi Carré 9
△ 115 gr A 36 mm C 86 mm L 86 mm CAP. 125 ml
△ 1/4 lbs H 1 3/8" L 3 3/8" W 3 3/8" CAP. 4 3/8 ml



CARRÉ 21100716
Taça Sobremesa 11
Dessert Bowl 11
Taza Postre 11
Coupe Dessert 11
△ 150 gr A 42 mm C 107 mm L 107 mm CAP. 246 ml
△ 1/3 lbs H 1 3/8" L 4 3/8" W 4 3/8" CAP. 8 1/2 oz



CARRÉ 21103824
Leiteira 25cl
Milk Jug 25cl
Lechera 25cl
Crémier 25cl
△ 215 gr A 96 mm C 89 mm L 64 mm CAP. 249 ml
△ 1/2 lbs H 3 7/8" L 3 1/2" W 2 1/2" CAP. 8 3/8 oz



CARRÉ 21103830
Açucareiro
Sugar Bowl
Azucarero
Sucrier
△ 282 gr A 102 mm C 82 mm L 82 mm CAP. 271 ml
△ 5/8 lbs H 4" L 3 3/8" W 3 3/8" CAP. 9 1/8 oz



CARRÉ 21103827
Bule 110cl
Tea Pot 110cl
Tetera 110cl
Théière 110cl
△ 930 gr A 143 mm C 234 mm L 128 mm CAP. 1076 ml
△ 2 lbs H 5 5/8" L 9 3/8" W 5" CAP. 36 3/8 oz



CARRÉ 21103828
Cafeteira 100cl
Coffee Pot 100cl
Cafetera 100cl
Cafetière 100cl
△ 939 gr A 197 mm C 220 mm L 105 mm CAP. 1152 ml
△ 2 1/6 lbs H 7 3/4" L 8 3/8" W 4 1/8" CAP. 39 oz



CARRÉ 21094087
Bandeja com Caneca
Mug & Tray
Mug con Bandeja
Grand Sous-tasse et Mug

CARRÉ 21090489
Caneca 31cl
Mug 31cl
Mug 31cl
Mug 31cl
△ 200 gr A 97 mm C 113 mm L 80 mm Ø 80 mm CAP. 307 ml
△ ¼ lbs H 3 ¾" L 4 ¾" W 3 ½" Ø 3 ½" CAP. 10 ¾ oz

CARRÉ 21097651
Bandeja Caneca
Mug Tray
Fuente Mug
Grand Sous-tasse
△ 423 gr A 27 mm C 219 mm L 149 mm
△ 1 lbs H 1" L 8 ¾" W 5 7/8"



CARRÉ 21091794
Chávena Pequeno Almoço com Pires 35cl
Breakfast Cup & Saucer 35cl
Taza Desayuno con Platillo 35cl
Tasse et Sous-tasse Petit Déjeuner 35cl

CARRÉ 21091819
Chávena Pequeno Almoço 35cl
Breakfast Cup 35cl
Taza Desayuno 35cl
Tasse Petit Déjeuner 35cl
△ 260 gr A 63 mm C 163 mm L 109 mm CAP. 353 ml
△ ½ lbs H 2 ½" L 6 ¾" W 4 ¾" CAP. 11 ¾ oz



CARRÉ 21090484
Chávena Chá com Pires 24cl
Tea Cup & Saucer 24cl
Taza Té con Platillo 24cl
Tasse et Sous-tasse Thé 24cl

CARRÉ 21091816
Chávena Chá 24cl
Tea Cup 24cl
Taza Té 24cl
Tasse Thé 24cl
△ 171 gr A 56 mm Ø 99 mm CAP. 238 ml
△ ¾ lbs H 2 ½" Ø 3 ¾" CAP. 8 oz



CARRÉ 21094089
Chávena Café com Pires 13cl
Coffee Cup & Saucer 13cl
Taza Café Cortado con Platillo 13cl
Tasse et Sous-tasse Café 13cl

CARRÉ 21094111
Chávena Café 13cl
Coffee Cup 13cl
Taza Café Cortado 13cl
Tasse Café 13cl
△ 119 gr A 59 mm Ø 71 mm CAP. 138 ml
△ ¼ lbs H 2 ½" Ø 2 ¾" CAP. 4 ¾ oz



CARRÉ 21090485
Chávena Café com Pires 8cl
Coffee Cup & Saucer 8cl
Taza Café Cortado con Platillo 8cl
Tasse et Sous-tasse Café 8cl

CARRÉ 21091817
Chávena Café 8cl
Coffee Cup 18cl
Taza Café Cortado 8cl
Tasse Café 8cl
△ 81 gr A 62 mm C 75 mm L 51 mm Ø 51 mm CAP. 76 ml
△ ½ lbs H 2 ¾" L 3" W 2" Ø 2" CAP. 2 ½ oz

CARRÉ 21091202
Pires Café 13cl
Coffee Saucer 13cl
Platillo Café Cortado 13cl
Sous-tasse Café 13cl
△ 243 gr A 23 mm C 136 mm L 136 mm
△ ½ lbs H 1" L 5 ½" W 5 ½"

CARRÉ 21091818
Pires Café 8cl
Coffee Saucer 8cl
Platillo Café Cortado 8cl
Sous-tasse Café 8cl
△ 81 gr A 19 mm C 97 mm L 97 mm
△ ½ lbs H ¾" L 3 ¾" W 3 ¾"



FIORD



A coleção Fiord centra-se no minimalismo e na simplicidade das formas que caracterizam o design nórdico. O conceito de «menos é mais» alia-se a pormenores simples, proporcionando uma superfície máxima para servir a comida e para elaborar combinações fantásticas de decoração de mesa.

Fiord collection is all about minimalism and clean shapes that defines Nordic design. It's less is more combined with simple details provides maximum area for presenting food and great combinations for table setting.

La colección Fiord se caracteriza por el minimalismo y la simplicidad de las formas que definen el diseño nórdico. El concepto de «menos es más», aliado a sencillos detalles, ofrece una mayor superficie para presentar comida y grandes combinaciones a la hora de poner la mesa.

La collection Fiord est un modèle de minimalisme et de formes épurées qui caractérisent le design nordique. Le « moins devient un plus » en liaison avec des motifs simples permet de laisser un espace maximal pour la présentation de la nourriture et une grande variété de combinaisons pour la décoration de la table.





FIORD 21133893
Prato Marcador 32
Charger Plate 32
Plato Presentación 32
Assiette de Présentation 32
△ 935 gr A 19 mm Ø 320 mm
△ 2 1/6 lbs H 3/8" Ø 10 1/4"



FIORD 27020939
Prato Raso 26
Dinner Plate 26
Plato Llano 26
Assiette Plate 26
△ 980 gr A 21 mm Ø 260 mm
△ 2 1/6 lbs H 5/8" Ø 10 1/4"

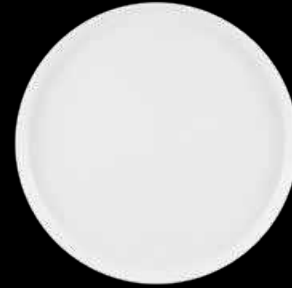

FIORD 21133894
Prato Raso 28
Dinner Plate 28
Plato Llano 28
Assiette Plate 28
△ 800 gr A 19 mm Ø 278 mm
△ 1 3/4 lbs H 3/8" Ø 11"



FIORD 21133895
Prato Sobremesa 22
Dessert Plate 22
Plato Postre 22
Assiette à Dessert 22
△ 545 gr A 19 mm Ø 220 mm
△ 1 1/5 lbs H 3/4" Ø 8 3/4"



FIORD 27020940
Prato Sobremesa 19
Dessert Plate 19
Plato Postre 19
Assiette à Dessert 19
△ 480 gr A 21 mm Ø 185 mm
△ 1 lbs H 5/8" Ø 7 3/4"

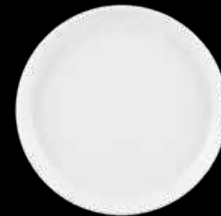

FIORD 21133896
Prato Pão 16
Bread & Butter Plate 16
Plato Pan 16
Assiette à Pain 16
△ 285 gr A 17 mm Ø 160 mm
△ 5/8 lbs H 3/8" Ø 6 1/4"



FIORD 21133890
Saladeira 25
Salad Bowl 25
Ensaladera 25
Saladier 25
△ 1350 gr A 103 mm Ø 249 mm
△ 3 lbs H 4" Ø 9 3/4"



FIORD 21133889
Tigela 18
Bowl 18
Bowl 18
Bol 18
△ 650 gr A 75 mm Ø 180 mm
△ 1 3/8 lbs H 3" Ø 7 1/8"



FIORD 21133888
Tigela 16
Bowl 16
Bowl 16
Bol 16
△ 350 gr A 59 mm Ø 139 mm
△ 7/8 lbs H 2 1/8" Ø 5 1/2"

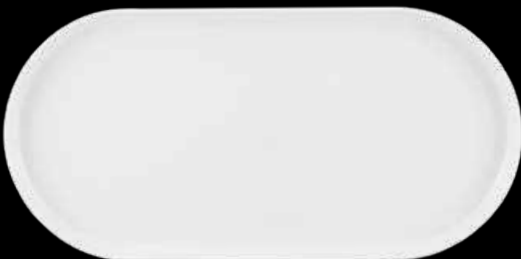

FIORD 21133891
Travessa Oval 40
Oval Platter 40
Fuente Oval 40
Plat à Servir Ovale 40
△ 1020 gr A 21 mm C 403 mm L 198 mm
△ 2 1/5 lbs H 5/8" L 15 5/8" W 7 7/8"

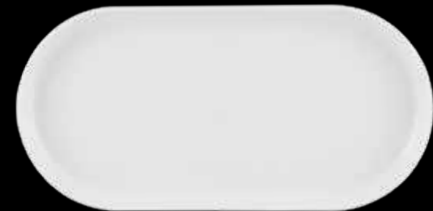

FIORD 21133892
Travessa Oval 32
Oval Platter 32
Fuente Oval 32
Plat à Servir Ovale 32
△ 700 gr A 21 mm C 323 mm L 159 mm
△ 1 1/2 lbs H 5/8" L 12 5/8" W 6 1/4"



GOURMET

Gourmet é um modelo elegante de design contemporâneo, destinado a restaurantes e hotéis com gastronomia de referência. Formas refinadas e inovadoras, dimensões generosas, elegância e funcionalidade permitem valorizar a arte de cada chef. Criado para satisfazer os requisitos tanto da cozinha tradicional como da cozinha moderna ao mais alto nível, *Gourmet* estabelece novos padrões de excelência.

The Gourmet is an elegant, contemporary model, designed for hotels and restaurants that value haute cuisine. Refined and innovative shapes, generous sizes and functionality that will surely add value to any chef's works of art. Designed to meet the highest requirements both of traditional and modern cuisine, the Gourmet sets new standards in excellence.

Gourmet es un modelo elegante de diseño contemporáneo, destinado a restaurantes y a hoteles puntos de referencia gastronómica. Formas refinadas e innovadoras, tamaño generoso, elegancia y funcionalidad permiten valorar el arte de cada chef. Creado para satisfacer los requisitos tanto de la cocina tradicional como los la cocina moderna al más alto nivel, Gourmet ha establecido nuevos niveles de excelencia.

Gourmet est un modèle de design contemporain élégant, destiné aux hôtels et restaurants avec une cuisine de référence. Des formes raffinées et innovantes, des dimensions généreuses, d'une élégance et fonctionnalité permettant de valoriser l'art de chaque chef. Créée pour répondre aux exigences de la cuisine traditionnelle et de la cuisine moderne au plus haut niveau, la collection Gourmet établit de nouveaux standards d'excellence.





GOURMET 21096358
 Travessa Grande 34
 Large Oval Platter 34
 Fuente Oval Grande 34
 Plat à Servir Oval Grand Modèle 34
 △1000 gr A 23 mm C 349 mm L 258 mm
 △2 1/2 lbs H 1" L 13 3/4" W 10 1/8"



GOURMET 21096359
 Travessa Pequena 28
 Small Oval Platter 28
 Fuente Oval Pequeña 28
 Plat à Servir Oval Petit Modèle 28
 △621 gr A 22 mm C 285 mm L 213 mm
 △1 3/8 lbs H 5/8" L 11 3/8" W 8 3/8"



GOURMET 21096347
 Prato Marcador 31
 Charger Plate 31
 Plato Presentación 31
 Assiette de Présentation 31
 △1032 gr A 23 mm C 313 mm
 △2 2/3 lbs H 1" Ø 12 1/2"



GOURMET 21096345
 Prato Raso 28
 Dinner Plate 28
 Plato Llano 28
 Assiette Plate 28
 △861 gr A 22 mm C 284 mm
 △1 8/8 lbs H 5/8" Ø 11 1/8"



GOURMET 21096349
 Prato Sopa 28
 Soup Plate 28
 Plato Hondo 28
 Assiette Creuse 28
 △763 gr A 47 mm C 280 mm CAP. 315 ml
 △1 2/3 lbs H 1 5/8" Ø 10 3/8" CAP. 11 oz



GOURMET 21096344
 Prato Sobremesa 22
 Dessert Plate 22
 Plato Postre 22
 Assiette à Dessert 22
 △472 gr A 18 mm C 227 mm
 △1 lbs H 3/8" Ø 9"



GOURMET 21096343
 Prato Doce 16
 Bread & Butter Plate 16
 Plato Pan 16
 Petit Assiette à Dessert 16
 △244 gr A 16 mm C 165 mm
 △1/2 lbs H 5/8" Ø 6 1/2"



GOURMET 21096346
 Prato Fundo 31
 Deep Plate 31
 Plato Hondo 31
 Plat Creux 31
 △949 gr A 41 mm C 312 mm CAP. 400 ml
 △2 lbs H 1 3/8" Ø 12 3/8" CAP. 13 1/2 oz



GOURMET 21096348
 Prato Apresentação 30
 Presentation Plate 30
 Plato Presentación 30
 Plat Présentation 30
 △934 gr A 28 mm C 301 mm
 △2 lbs H 1 1/8" Ø 11 5/8"



GOURMET 21096360
 Manteigueira
 Butter Dish
 Plato Mantequilla
 Beurrier
 △170 gr A 30 mm C 110 mm CAP. 131 ml
 △3/8 lbs H 1 1/8" Ø 4 1/8" CAP. 4 3/8 oz



GOURMET 21096357
 Conserveira
 Olive Dish
 Rabanera
 Ravier
 △218 gr A 27 mm C 202 mm L 102 ml
 △1/2 lbs H 1" L 8" W 4"



GOURMET 21111633
 Prato Sopa com Tampa 29
 Soup Plate & Cover 29
 Plato Hondo con Tapa 29
 Assiette Creuse avec Cloche 29

GOURMET 21111628
 Prato Sopa 29
 Soup Plate 29
 Plato Hondo 29
 Assiette Creuse 29
 △492 gr A 43 mm C 242 mm CAP. 338 ml
 △1 lbs H 1 3/8" Ø 9 1/2" CAP. 11 3/8 oz



GOURMET 21111635
 Prato Cocktail com Tampa 20
 Cocktail Plate & Cover 20
 Plato Cocktail con Tapa 20
 Assiette Cocktail avec Cloche 20

GOURMET 21111632
 Prato Cocktail 20
 Cocktail Plate 20
 Plato Cocktail 20
 Assiette Cocktail 20
 △324 gr A 42 mm C 202 mm CAP. 205 ml
 △5/8 lbs H 1 3/8" Ø 8" CAP. 7 oz

GOURMET 21111636
 Tampa Prato Sopa 29
 Cover Soup Plate 29
 Tapa Plato Hondo 29
 Cloche Assiette Creuse 29
 △396 gr A 87 mm C 169 mm
 △7/8 lbs H 3 3/8" Ø 6 3/8"

GOURMET 21111637
 Tampa Prato Cocktail 20
 Cover Cocktail Plate 20
 Tapa Plato Cocktail 20
 Cloche Assiette Cocktail 20
 △233 gr A 68 mm C 133 mm
 △1/2 lbs H 2 3/8" Ø 5 1/8"



GOURMET 21096351
Saladeira Grande 23
Large Salad Bowl 23
Ensaladera Grande 23
Saladier Grand Modèle 23
△ 781 gr A 91 mm C 249 mm L 206 mm CAP. 1514 ml
△ 1 3/4 lbs H 3 3/4" L 9 3/4" W 8 1/8" CAP. 51 1/2 oz



GOURMET 21096350
Saladeira Pequena 16
Small Salad Bowl 16
Ensaladera Pequeña 16
Saladier Petit Modèle 16
△ 387 gr A 76 mm C 177 mm L 139 mm CAP. 594 ml
△ 3/4 lbs H 3" L 7" W 5 1/2" CAP. 20 oz



GOURMET 21096352
Tigela Cereais 14
Cereal Bowl 14
Bowl Cereales 14
Bol Céréales 14
△ 295 gr A 64 mm Ø 141 mm CAP. 406 ml
△ 3/4 lbs H 2 1/2" Ø 5 5/8" CAP. 13 3/4 oz



GOURMET 21122346
Tigela Cereais 11
Cereal Bowl 11
Bowl Cereales 11
Bol Céréales 11
△ 136 gr A 44 mm C 110 mm L 90 mm CAP. 130 ml
△ 3/4 lbs H 1 3/4" L 4 1/4" W 3 1/2" CAP. 4 3/5 oz



GOURMET 21104462
Chávena Consomé com Pires 30cl
Consomme Cup & Saucer 30cl
Taza Consomé con Platillo 30cl
Tasse et Soucoupe Bouillon 30cl

GOURMET 21104440
Chávena Consomé 30cl
Consomme Cup 30cl
Taza Consomé 30cl
Tasse Bouillon 30cl
△ 313 gr A 64 mm C 158 mm L 121 mm CAP. 307 ml
△ 3/4 lbs H 2 1/2" L 6 3/8" W 3 4/8" CAP. 10 3/8 oz



GOURMET 21096335
Açucareiro
Sugar Bowl
Azucarero
Sucrier
△ 295 gr A 119 mm C 96 mm L 67 mm CAP. 191 ml
△ 3/4 lbs H 4 3/8" L 3 5/8" W 2 3/8" CAP. 6 1/2 oz



GOURMET 21096334
Açucareiro Pacotes
Sugar Box
Azucarero Paquetes
Sucrier Sachets de Sucre
△ 180 gr A 68 mm C 87 mm L 64 mm
△ 3/4 lbs H 2 3/4" L 3 3/8" W 2 1/2"



GOURMET 21096340
Leiteira 23cl
Milk Jug 23cl
Lechera 23cl
Crémier 23cl
△ 254 gr A 101 mm C 142 mm L 59 mm CAP. 232 ml
△ 3/6 lbs H 4" L 5 3/8" W 2 1/2" CAP. 7 3/8 oz



GOURMET 21096336
Bule 40cl
Tea Pot 40cl
Tetera 40cl
Théière 40cl
△ 481 gr A 160 mm C 181 mm L 69 mm CAP. 412 ml
△ 1 lbs H 6 3/8" L 7 1/8" W 2 5/8" CAP. 14 oz



GOURMET 21096354
Chávena Chá com Pires 18cl
Tea Cup & Saucer 18cl
Taza Té con Platillo 18cl
Tasse et Sous-tasse Thé 18cl

GOURMET 21096339
Chávena Chá 18cl
Tea Cup 18cl
Taza Té 18cl
Tasse Thé 18cl
△ 202 gr A 83 mm Ø 87 mm CAP. 183 ml
△ 3/6 lbs H 3 1/4" Ø 3 3/8" CAP. 6 1/2 oz



GOURMET 21096355
Chávena Café com Pires 13cl
Coffee Cup & Saucer 13cl
Taza Café Cortado con Platillo 13cl
Tasse et Sous-tasse Café 13cl

GOURMET 21096337
Chávena Café 13cl
Coffee Cup 13cl
Taza Café Cortado 13cl
Tasse Café 13cl
△ 155 gr A 65 mm C 105 mm L 51 mm CAP. 117 ml
△ 1/3 lbs H 2 3/8" L 4 1/8" W 2" CAP. 4 oz



GOURMET 21096353
Chávena Café com Pires 9cl
Coffee Cup & Saucer 9cl
Taza Café Cortado con Platillo 9cl
Tasse et Sous-tasse Café 9cl

GOURMET 21096338
Chávena Café 9cl
Coffee Cup 9cl
Taza Café Cortado 9cl
Tasse Café 9cl
△ 129 gr A 72 mm C 95 mm L 67 mm CAP. 88 ml
△ 3/6 lbs H 2 3/8" L 3 3/8" W 2 3/8" CAP. 3 oz

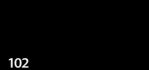

GOURMET 21096342
Pires Chá 18cl
Tea Saucer 18cl
Platillo Té 18cl
Sous-tasse Thé 18cl
△ 184 gr A 24 mm C 159 mm L 131 mm
△ 3/6 lbs H 1" L 6 1/4" W 5 1/8"

GOURMET 21096342
Pires Café 9cl
Coffee Saucer 9cl
Platillo Café Cortado 9cl
Sous-tasse Café 9cl
△ 102 gr A 17 mm C 125 mm L 102 mm
△ 3/6 lbs H 3/8" L 5" W 4"

GOURMET 21096341
Pires Café 9cl
Coffee Saucer 9cl
Platillo Café Cortado 9cl
Sous-tasse Café 9cl
△ 102 gr A 18 mm C 125 mm L 102 mm
△ 3/6 lbs H 3/8" L 5" W 4"

GOURMET 21096341
Pires Café 9cl
Coffee Saucer 9cl
Platillo Café Cortado 9cl
Sous-tasse Café 9cl
△ 102 gr A 18 mm C 125 mm L 102 mm
△ 3/6 lbs H 3/8" L 5" W 4"





KARMA

Uma linha orgânica com uma estética refinada e subtil. As suas linhas suaves sobressaem ao primeiro olhar. Karma é um modelo ideal para quem procura soluções ergonómicas e funcionais, sempre com um design inovador e a superior qualidade Vista Alegre.

An organic line with refined and subtle aesthetics. Its smooth lines quickly catch the eye. Karma is the ideal model for those looking for functional and ergonomic solutions, without compromising on innovative design, with the Vista Alegre superior quality seal.

Una línea orgánica con una estética refinada y sutil. Sus líneas suaves destacan a primera vista. Karma es un modelo ideal para quienes buscan soluciones ergonómicas y funcionales, siempre con un diseño innovador y la calidad superior Vista Alegre.

Une ligne organique avec une esthétique raffinée et subtile. Ses lignes douces se distinguent à première vue. Karma est le modèle idéal pour ceux qui cherchent des solutions fonctionnelles et ergonomiques, toujours avec un design innovant et la qualité supérieure de Vista Alegre.





KARMA 21108772
Prato Grande com Taça 38
Large Plate & Bowl 38
Plato Grande con Bowl 38
Grand Assiette avec Coupelle 38
△1529 gr A 51 mm C 385 mm L 307 mm CAP. 89 ml
△3 3/8 lbs H 2" L 15 1/8" W 12" CAP. 3 oz



KARMA 21108765
Prato Raso 28
Dinner Plate 28
Plato Llano 28
Assiette Plate 28
△813 gr A 28 mm Ø 276 mm
△1 1/8 lbs H 1 1/8" Ø 10 7/8"



KARMA 21108766
Prato Sopa 27
Soup Plate 27
Plato Hondo 27
Assiette Creuse 27
△763 gr A 43 mm Ø 264 mm CAP. 1277 ml
△1 7/8 lbs H 1 7/8" Ø 10 2/8" CAP. 43 1/8 oz



KARMA 21108767
Prato Sobremesa 22
Dessert Plate 22
Plato Postre 22
Assiette à Dessert 22
△467 gr A 25 mm C 223 mm L 218 mm
△1 lbs H 1" L 8 7/8" W 8 4/8"



KARMA 21108768
Prato 17
Plate 17
Plato 17
Assiette 17
△249 gr A 21 mm C 178 mm L 170 mm
△3/8 lbs H 3/8" L 7" W 6 3/8"



KARMA 21108770
Tigela 17
Bowl 17
Bowl 17
Coupe 17
△300 gr A 53 mm C 168 mm L 159 mm CAP. 584 ml
△2/8 lbs H 2" L 7" W 6 3/8" CAP. 19 3/4 oz



KARMA 21108775
Taça com Pires 7cl
Bowl & Saucer 7cl
Bowl con Platillo 7cl
Tasse et Sous-tasse 7cl
△198 gr A 56 mm C 142 mm L 129 mm
△3/8 lbs H 2 1/8" L 5 3/8" W 5"



KARMA 21122285
Taça 7cl
Bowl 7cl
Bowl 7cl
Tasse 7cl
△78 gr A 51 mm Ø 66 mm CAP. 89 ml
△1/8 lbs H 2" Ø 2 3/8" CAP. 3 oz



KARMA 21108773
Caneca 31cl
Mug 31cl
Mug 31cl
Mug 31cl
△228 gr A 72 mm C 126 mm L 94 mm CAP. 314 ml
△1/2 lbs H 2 3/8" L 5" W 3 3/8" CAP. 10 3/8 oz



KARMA 21108771
Châvena Café com Pires 9cl
Coffee Cup & Saucer 9cl
Taza Café Cortado con Platillo 9cl
Tasse et Sous-tasse Café 9cl

KARMA 21111284
Châvena Café 9cl
Coffee Cup 9cl
Taza Café Cortado 9cl
Tasse Café 9cl
△84 gr A 51 mm C 87 mm L 66 mm CAP. 88 ml
△1/8 lbs H 2" L 3 3/8" W 2 3/8" CAP. 3 oz

KARMA 21111892
Pires Café 9cl
Coffee Saucer 9cl
Platillo Café Cortado 9cl
Sous-tasse Café 9cl
△120 gr A 17 mm C 141 mm L 127 mm
△1/4 lbs H 2/8" L 5 3/8" W 5"



KYOTO

A tranquilidade e organicidade da cultura japonesas são refletidas em Kyoto, um conjunto concebido especialmente para desfrutar das iguarias orientais. Taças para sopa, arroz, vegetais e um pausa-pauzinhos fazem parte deste set em branco sereno, em harmonia perfeita com os alimentos consumidos e com o ambiente em que se enquadra a experiência gastronômica.

The tranquility and organic nature of Japanese culture are reflected in Kyoto White collection, a set specially designed to enjoy oriental delicacies. Soup, rice and vegetable bowls and chopstick rests are part of this set in serene white, in perfect harmony with the food served and with the atmosphere of the dining experience.

La tranquilidad y la organicidad de la cultura Japonesa se reflejen en la colección Kyoto White, un conjunto diseñado especialmente para saborear manjares orientales. Tazones de sopa, arroz, verduras y posa de palillos integran este conjunto. La serenidad de su color blanco en perfecta armonía con la comida combina con el ambiente en que el que se desarrolla esta experiencia culinaria.

La tranquillité et la nature organique de la culture japonaise sont présentes dans la collection Kyoto White, un ensemble spécialement conçu pour déguster les délices de l'orient. Bols de soupe, à riz, aux légumes et un repose-baguettes font partie de cet ensemble en blanc serein, en parfaite harmonie avec les aliments consommés et avec l'ambiance d'une expérience gastronomique.



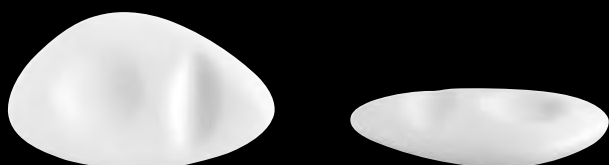

KYOTO 21130978
 Pousa Pausinhos
 Spoon & Chopstick Rest
 Posa Palillos
 Repose Baguettes
 △ 77 gr A 20 mm C 107 mm L 64 mm
 △ 1/6 lbs H 3/8" L 4 3/8" W 2 1/2"



KYOTO 21123704
 Taça Sopa 14
 Soup Bowl 14
 Tazón de Sopa 14
 Bol de Soupe 14
 △ 263 gr A 64 mm Ø 141 mm CAP. 541 ml
 △ 3/4 lbs H 2 1/2" Ø 5 5/8" CAP. 18 3/4 oz



KYOTO 21123706
 Taça Arroz 11
 Rice Bowl 11
 Tazón de Arroz 11
 Bol à Riz 11
 △ 198 gr A 65 mm Ø 110 mm CAP. 334 ml
 △ 3/8 lbs H 2 5/8" Ø 4 1/8" CAP. 11 3/4 oz



KYOTO 21130979
 Taça Vegetais
 Vegetables Bowl
 Tazón de Vegetables
 Bol aux Légumes
 △ 158 gr A 54 mm Ø 104 mm
 △ 1/3 lbs H 2 1/8" Ø 4 1/8"



MULTIFORMA by Mikaela Dörfel

Multiforma constitui um conceito de mesa da Vista Alegre, criado e concebido para satisfazer as necessidades e as aspirações dos chefs e restaurantes contemporâneos, direcionado a clientes que pretendem um posicionamento diferenciador com um impacto visual original. Este serviço de 40 itens apresenta três formas e estilos distintos – oval, redondo e gota – que podem combinar-se de forma criativa. *Multiforma* é um modelo com características únicas e inovadoras, criado pela designer Mikaela Dörfel, um dos nomes europeus mais reconhecidos na área da apresentação gastronómica.

Multiforma is a table set concept created by Vista Alegre, designed to meet the needs and aspirations of contemporary chefs and restaurants, aimed at customers who look for distinctive positioning, with a unique visual impact. This 40-piece set features three distinct styles and shapes – oval, round and drop – which can be combined in creative ways. The Multiforma is a model with unique and innovative features, created by designer Mikaela Dörfel, one of Europe's most prominent names in food presentation.

Multiforma constituye un concepto de mesa de Vista Alegre, creado y concebido para satisfacer las necesidades y las aspiraciones de los chefs y restaurantes contemporáneos, dirigido a clientes que pretenden un posicionamiento diferenciador con un impacto visual original. Esta vajilla de 40 piezas presenta tres formas y estilos distintos – oval, redondo y forma de gota – que se pueden combinar entre sí de forma creativa. Multiforma es un modelo con características únicas e innovadoras, creado por la diseñadora Mikaela Dörfel, uno de los nombres europeos más reconocidos en el área de la presentación gastronómica.

Multiforma est un concept d'art de la table de Vista Alegre, créé et conçu pour répondre aux besoins et aux aspirations des chefs et des restaurants contemporains, s'adressant à des clients qui souhaitent un positionnement distinctif avec un impact visuel unique. Ce service de 40 pièces est composé de trois formes et styles distincts – ovale, rond et goutte – qui peuvent être combinés de façon créative. Multiforma est un modèle avec des caractéristiques uniques et innovantes, créé par le designer Mikaela Dörfel, l'un des noms européens les plus reconnus dans le domaine de la présentation culinaire.





MULTIFORMA 21104684
 Travessa Oval 39x24
 Oval Platter 39x24
 Fuente Oval 39x24
 Plat à Servir Ovale 39x24
 △1182 gr A 24 mm C 393 mm L 245 mm
 △2 3/5 lbs H 1" L 15 1/2" W 9 3/8"



MULTIFORMA 21104683
 Travessa Oval 34x21
 Oval Platter 34x21
 Fuente Oval 34x21
 Plat à Servir Ovale 34x21
 △868 gr A 25 mm C 388 mm L 210 mm
 △2 lbs H 1" L 3 1/3" W 13 1/8"



MULTIFORMA 21104682
 Travessa Oval 29x18
 Oval Platter 29x18
 Fuente Oval 29x18
 Plat à Servir Ovale 29x18
 △605 gr A 25 mm C 288 mm L 177 mm
 △1 1/5 lbs H 1" L 11 1/3" W 7"



MULTIFORMA 21104681
 Travessa Oval 25x16
 Oval Platter 25x16
 Fuente Oval 25x16
 Plat à Servir Ovale 25x16
 △411 gr A 23 mm C 252 mm L 156 mm
 △1 lbs H 1" L 10" W 6 1/2"



MULTIFORMA 21104686
 Travessa Peixe Gota 42x20
 Drop Fish Platter 42x20
 Fuente Pescado Gota 42x20
 Plat à Servir Poisson Goutte 42x20
 △1177 gr A 48 mm C 418 mm L 204 mm
 △2 3/5 lbs H 1 3/8" L 16 1/2" W 8"



MULTIFORMA 21104671
 Travessa Funda Gota 35x17
 Drop Deep Platter 35x17
 Fuente Honda Gota 35x17
 Plat à Servir Creux Goutte 35x17
 △733 gr A 48 mm C 350 mm L 166 mm
 △1 3/8 lbs H 1 3/8" L 13 7/8" W 6 1/2"



MULTIFORMA 21104685
 Prato Gourmet Gota 39x27
 Drop Gourmet Plate 39x27
 Plato Gourmet Gota 39x27
 Assiette Gourmet Goutte 39x27
 △1394 gr A 54 mm C 384 mm L 277 mm
 △3 lbs H 2 1/8" L 15 1/8" W 11"



MULTIFORMA 21104677
 Prato Raso Gota 32x28
 Drop Dinner Plate 32x28
 Plato Llano Gota 32x28
 Assiette Plate Goutte 32x28
 △1024 gr A 35 mm C 319 mm L 274 mm
 △2 1/4 lbs H 1 3/8" L 12 5/8" W 10 3/8"



MULTIFORMA 21104675
 Prato Raso Gota 28x24
 Drop Dinner Plate 28x24
 Plato Llano Gota 28x24
 Assiette Plate Goutte 28x24
 △685 gr A 34 mm C 276 mm L 234 mm
 △1 1/2 lbs H 1 1/2" L 10 5/8" W 9 1/2"



MULTIFORMA 21104676
 Prato Pasta Gota 33x28
 Drop Pasta Plate 33x28
 Plato Pasta Gota 33x28
 Assiette à Pâtes Goutte 33x28
 △1137 gr A 61 mm C 326 mm
 L 276 mm CAP. 1026 ml
 △2 1/2 lbs H 2 3/8" L 12 5/8" W 10 5/8" CAP. 34 3/5 oz



MULTIFORMA 21104673
 Prato Sopa Gota 26x22
 Drop Soup Plate 26x22
 Plato Sopa Gota 26x22
 Assiette Creuse Goutte 26x22
 △551 gr A 44 mm C 255 mm L 219 mm
 △1 2/9 lbs H 1 3/4" L 10" W 8 3/8"



MULTIFORMA 21104672
 Prato Pão Gota 20x17
 Drop Bread & Butter Plate 20x17
 Plato Pan Gota 20x17
 Assiette à Pain Goutte 20x17
 △319 gr A 30 mm C 198 mm L 168 mm
 △3/7 lbs H 1 1/8" L 7 4/8" W 6 3/8"



MULTIFORMA 21104678
 Prato Manteiga Gota 11x10
 Drop Butter Plate 11x10
 Plato Mantequilla Gota 11x10
 Assiette à Beurre Goutte 11x10
 △80 gr A 20 mm C 109 mm L 91 mm
 △1/6 lbs H 4/8" L 4 3/8" W 3 4/8"



MULTIFORMA 21104670
 Prato Entrada Gota 28x14
 Drop Starter Plate 28x14
 Plato Entrantes Gota 28x14
 Assiette Hors D'Oeuvres Goutte 28x14
 △453 gr A 36 mm C 279 mm L 137 mm
 △1 lbs H 1 3/8" L 11" W 5 3/8"



MULTIFORMA 21104669
 Prato Acepipes Gota 24x12
 Drop Appetiser Plate 24x12
 Plato Aperitivos Gota 24x12
 Assiette Apéritifs Goutte 24x12
 △308 gr A 35 mm C 236 mm L 119 mm
 △3/5 lbs H 1 3/8" L 9 3/8" W 4 3/8"



MULTIFORMA 21104680
Prato Marcador Redondo 33
Round Charger Plate 33
Plato Presentación Redondo 33
Assiette de Présentation Ronde 33
△ 1121 gr A 21 mm Ø 329 mm
△ 2 ½ lbs H ¾" Ø 13"



MULTIFORMA 21104679
Prato Raso Redondo 28
Round Dinner Plate 28
Plato Llano Redondo 28
Assiette Plate Ronde 28
△ 784 gr A 23 mm Ø 281 mm
△ 1 ¾ lbs H 1" Ø 11"



MULTIFORMA 21109342
Prato Redondo Raso 25
Round Dinner Plate 25
Plato Redondo Llano 25
Assiette Plate Ronde 25
△ 591 gr A 24 mm Ø 246 mm
△ 1 ½ lbs H 1" Ø 9 ¾"



MULTIFORMA 21104674
Prato Sobremesa Redondo 22
Round Dessert Plate 22
Plato Postre Redondo 22
Assiette à Dessert Ronde 22
△ 433 gr A 20 mm Ø 220 mm
△ 1 lbs H ¾" Ø 8 ¾"



MULTIFORMA 21109317
Prato Pão Redondo 16
Round Bread & Butter Plate 16
Plato Pan Redondo 16
Assiette à Pain Ronde 16
△ 228 gr A 18 mm Ø 161 mm
△ ½ lbs H ½" Ø 6 ¼"



MULTIFORMA 21104687
Conserveira
Olive Dish
Rabanera
Ravier
△ 173 gr A 37 mm C 239 mm C 61 mm
△ ¾ lbs H 1 ½" L 9 ¾" L 2 ¾"



MULTIFORMA 21104702
Saladeira Redonda 21
Round Salad Bowl 21
Ensaladera Redonda 21
Saladier Rond 21
△ 746 gr A 76 mm Ø 215 mm CAP. 1320 ml
△ 1 ¾ lbs H 3" Ø 8 ½" CAP. 44 ¾ oz



MULTIFORMA 21104711
Molheira 20cl
Sauceboat 20cl
Salsera 20cl
Saucière 20cl
△ 211 gr A 80 mm C 136 mm L 82 mm CAP. 215 ml
△ ½ lbs H 3 ¼" L 5 ½" W 3 ¾" CAP. 7 ¼ oz



MULTIFORMA 21104700
Tigela Gota 16
Drop Bowl 16
Bowl Gota 16
Coupe Goutte 16
△ 300 gr A 60 mm C 165 mm L 138 mm CAP. 360 ml
△ ¾ lbs H 2 ½" L 6 ½" W 5 ¾" CAP. 12 ½ oz



MULTIFORMA 21104701
Tigela Redonda 16
Round Bowl 16
Bowl Redonda 16
Coupe Ronde 16
△ 303 gr A 44 mm Ø 159 mm CAP. 413 ml
△ ¾ lbs H 1 ¾" Ø 6 ¼" CAP. 14 oz



MULTIFORMA 21104706
Leiteira Grande 30cl
Large Milk Jug 30cl
Lechera Grande 30cl
Crémier Grand Modèle 30cl
△ 301 gr A 113 mm C 149 mm L 77 mm CAP. 328 ml
△ ¾ lbs H 4 ¾" L 5 ¾" W 3" CAP. 11 oz



MULTIFORMA 21104705
Leiteira Pequena 15cl
Small Milk Jug 15cl
Lechera Pequeña 15cl
Crémier Petit Modèle 15cl
△ 178 gr A 92 mm C 116 mm L 61 mm CAP. 153 ml
△ ¾ lbs H 3 ¾" L 4 ¾" W 2 ¾" CAP. 5 ¼ oz



MULTIFORMA 21104789
Açucareiro
Sugar Bowl
Azucarero
Sucrier
△ 259 gr A 98 mm Ø 92 mm CAP. 303 ml
△ ¾ lbs H 3 ¾" Ø 3 ¾" CAP. 10 ¼ oz



MULTIFORMA 21104712
Açucareiro Pacotes
Sugar Box
Azucarero Paquetes
Sucrier Sachets de Sucre
△ 207 gr A 75 mm C 142 mm L 82 mm CAP. 334 ml
△ ½ lbs H 3" L 5 ¾" W 3 ¾" CAP. 8 oz



MULTIFORMA 21104710
Bule Grande 80cl
Large Tea Pot 80cl
Tetera Grande 80cl
Théière Grand Modèle 80cl
△ 800 gr A 134 mm C 204 mm L 129 mm CAP. 835 ml
△ 1 ¾ lbs H 5 ¾" L 8" W 5" CAP. 28 ¼ oz



MULTIFORMA 21104709
Bule Pequeno 40cl
Small Tea Pot 40cl
Tetera Pequeña 40cl
Théière Petit Modèle 40cl
△ 462 gr A 108 mm C 162 mm L 104 mm CAP. 411 ml
△ 1 lbs H 4 ¼" L 6 ¾" W 4" CAP. 13 ¾ oz





MULTIFORMA 21104708
Cafeteira Grande 80cl
Large Coffee Pot 80cl
Cafeteira Grande 80cl
Cafetière Grand Modèle 80cl
△ 831 gr A 162 mm C 201 mm L 104 mm CAP. 790 ml
△ 1 3/8 lbs H 6 3/8" L 8" W 4" CAP. 26 3/4 oz



MULTIFORMA 21104707
Cafeteira Pequena 40cl
Small Coffee Pot 40cl
Cafeteira Pequena 40cl
Cafetière Petit Modèle 40cl
△ 441 gr A 133 mm C 161 mm L 84 mm CAP. 418 ml
△ 1 lbs H 5 1/4" L 6 1/8" W 3 1/8" CAP. 14 1/2 oz



MULTIFORMA 21104697
Châvena Consomé com Pires 30cl
Consomme Cup & Saucer 30cl
Taza Consomé con Platillo 30cl
Tasse et Soucoupe Bouillon 30cl

MULTIFORMA 21104696
Châvena Consomé 30cl
Consomme Cup 30cl
Taza Consomé 30cl
Tasse Bouillon 30cl
△ 259 gr A 52 mm C 152 mm L 103 mm CAP. 282 ml
△ 1/2 lbs H 2" L 6" W 4" CAP. 9 1/2 oz

MULTIFORMA 21104698
Pires Consomé 30cl
Consomme Saucer 30cl
Platillo Consomé 30cl
Soucoupe Bouillon 30cl
△ 213 gr A 28 mm C 170 mm L 152 mm
△ 1/2 lbs H 1 1/8" L 6 3/8" W 6"



MULTIFORMA 21104695
Châvena Pequeno Almoço com Pires 35cl
Breakfast Cup & Saucer 35cl
Taza Desayuno con Platillo 35cl
Tasse et Sous-tasse Petit Déjeuner 35cl

MULTIFORMA 21104694
Châvena Pequeno Almoço 35cl
Breakfast Cup 35cl
Taza Desayuno 35cl
Tasse Petit Déjeuner 35cl
△ 294 gr A 76 mm C 122 mm L 90 mm CAP. 333 ml
△ 3/8 lbs H 3" L 4 1/8" W 3 1/2" CAP. 11 1/4 oz



MULTIFORMA 21104693
Châvena Chá com Pires 20cl
Tea Cup & Saucer 20cl
Taza Té con Platillo 20cl
Tasse et Sous-tasse Thé 20cl

MULTIFORMA 21104692
Châvena Chá 20cl
Tea Cup 20cl
Taza Té 20cl
Tasse Thé 20cl
△ 214 gr A 56 mm C 114 mm L 88 mm CAP. 224 ml
△ 1/2 lbs H 2 1/8" L 4 1/2" W 3 1/2" CAP. 7 4/7 oz

MULTIFORMA 21104698
Pires Chá 20cl
Tea Saucer 20cl
Platillo Te 20cl
Sous-tasse Thé 20cl
△ 213 gr A 28 mm C 170 mm L 152 mm
△ 1/2 lbs H 1 1/8" L 6 3/8" W 6"



MULTIFORMA 21104691
Châvena Café com Pires 13cl
Coffee Cup & Saucer 13cl
Taza Café Cortado con Platillo 13cl
Tasse et Sous-tasse Café 13cl

MULTIFORMA 21104690
Châvena Café 13cl
Coffee Cup 13cl
Taza Café Cortado 13cl
Tasse Café 13cl
△ 138 gr A 50 mm C 94 mm L 69 mm CAP. 114 ml
△ 1/8 lbs H 2" L 3 3/8" W 2 5/8" CAP. 3 9/8 oz



MULTIFORMA 21104689
Châvena Café com Pires 9cl
Coffee Cup & Saucer 9cl
Taza Café con Platillo 9cl
Tasse et Sous-tasse Café 9cl

MULTIFORMA 21104688
Châvena Café 9cl
Coffee Cup 9cl
Taza Café 9cl
Tasse Café 9cl
△ 116 gr A 58 mm C 79 mm L 55 mm CAP. 87 ml
△ 1/4 lbs H 2 3/8" L 6" W 2 1/8" CAP. 3 oz

MULTIFORMA 21104699
Pires Café 9cl
Coffee Saucer 9cl
Platillo Café 9cl
Sous-tasse Café 9cl
△ 118 gr A 23 mm C 127 mm L 111 mm
△ 1/4 lbs H 1" L 5" W 4 3/8"



MULTIFORMA 21104703
Saleiro
Salt
Salero
Salière
△ 76 gr A 66 mm C 58 mm L 48 mm
△ 1/6 lbs H 2 3/8" L 2 3/8" W 1 9/8"



MULTIFORMA 21104704
Pimenteiro
Pepper
Pimentero
Poivrière
△ 67 gr A 60 mm C 59 mm L 58 mm
△ 1/8 lbs H 2 1/8" L 2 1/8" W 2 1/8"





NATURA LINE by Chef Vitor Matos

Em colaboração com a Vista Alegre, o Chef Vitor Matos procurou transpor os elementos essenciais da natureza para uma nova coleção com caráter na forma, mas mantendo a harmonia da sua inspiração orgânica no design.

In collaboration with Vista Alegre, Chef Vitor Matos aimed to transpose the essential elements of nature to a new collection with a shape character, while maintaining the harmony of its organic inspiration in the design.

En colaboración con Vista Alegre, el Chef Vitor Matos trató de incorporar los elementos esenciales de la naturaleza a una nueva colección con enfoque en la forma, pero mantenimiento la armonía de su inspiración orgánica en su diseño.

En collaboration avec Vista Alegre, le chef Vitor Matos a cherché à transposer les éléments essentiels de la nature en une nouvelle collection avec caractère dans la forme, tout en maintenant l'harmonie de son inspiration organique en sa conception.





NATURA LINE 21133211
Prato Raso 28
Dinner Plate 28
Plato Llano 28
Assiette Plate 28
△ 747 gr A 28 mm Ø 278 mm
△ 1 3/8 lbs H 1 1/8" Ø 11"



NATURA LINE 21133212
Prato Sopa 27
Soup Plate 27
Plato Sopa 27
Assiette Creuse 27
△ 731 gr A 42 mm Ø 269 mm
△ 1 3/8 lbs H 1 3/8" Ø 10 3/8"



NATURA LINE 21133213
Prato Sobremesa 24
Dessert Plate 24
Plato Postre 24
Assiette à Dessert 24
△ 516 gr A 26 mm Ø 237 mm
△ 1 1/8 lbs H 1" Ø 9 1/8"



NATURA LINE 21135887
Chávena Chá 20cl
Tea Cup 20cl
Taza Té 20cl
Tasse Thé 20cl
△ 200 gr A 67 mm C 104 mm L 78 mm
△ 3/8 lbs H 2 3/8" L 4" W 3"



NATURA LINE 21135898
Chávena Café 13cl
Coffee Cup 13cl
Taza Café 13cl
Tasse Café 13cl
△ 150 gr A 60 mm C 89 mm L 68 mm
△ 1/3 lbs H 2 1/8" L 3 1/8" W 2 3/8"



NATURA LINE 21133216
Caneca Emp
St Mug
St Mug
Mug Emp
△ 270 gr A 94 mm C 110 mm L 84 mm
△ 3/8 lbs H 3 3/8" L 4 1/8" W 3 3/8"



NATURA LINE 21135899
Pires Oval 25
Oval Saucer 25
Platillo Oval 25
Sous-tasse Ovale 25
△ 398 gr A 23 mm C 250 mm L 154 mm
△ 3/8 lbs H 1" L 9 3/8" W 6"



NATURA LINE 21135900
Pires Redondo 15
Round Saucer 15
Platillo Redondo 15
Sous-tasse Ronde 15
△ 200 gr A 21 mm Ø 150 mm
△ 3/8 lbs H 3/8" Ø 6"



NATURA LINE 21133214
Açucareiro
Sugar Bowl
Azucarero
Sucrier
△ 150 gr A 72 mm Ø 66 mm
△ 1/3 lbs H 2 3/8" Ø 2 3/8"



NATURA LINE 21133215
Tigela 30 cl
Bowl 30 cl
Bowl 30 cl
Bol 30 cl
△ 280 gr A 65 mm Ø 138 mm
△ 3/8 lbs H 2 3/8" Ø 5 3/8"



OPTIMA

A vitalidade e irreverência de *Optima* expressam-se num pires redondo e num pires oval, numa chávena tulipa e numa chávena triangular, que podem ser combinados, dando origem a quatro conjuntos originais e convidativos, ideias para servir o café após qualquer refeição.

Optima expresses vitality and irreverence in a round saucer and an oval one, a tulip cup and a triangular cup, which can all be combined, resulting in four original and inviting sets, ideal for serving coffee after every meal.

La vitalidad e irreverencia de Optima se expresan en un platillo para taza redondo y otro oval, en una taza en forma de tulipán y otra en forma triangular, que se pueden combinar, formando cuatro conjuntos originales y atractivos, ideales para servir el café después de la comida.

La vitalité et l'audace de la collection Optima sont exprimées dans une sous-tasse ronde et une sous-tasse ovale, une tasse tulipe et une tasse triangulaire, qui peuvent être combinées, donnant lieu à quatre ensembles originaux et attractifs, des idées différentes pour servir le café après le repas.





OPTIMA 21108924
 Chávena Café Tulipa 9cl
 Coffee Cup Tulip 9cl
 Taza Café Tulipán 9cl
 Tasse Café Tulipe 9cl
 Δ 110 gr A 67 mm C 77 mm L 52 mm CAP. 88 ml
 Δ ¼ lbs H 2 ¾" L 3" W 2" CAP. 3 oz



OPTIMA 21108924
 Chávena Café Tulipa 9cl
 Coffee Cup Tulip 9cl
 Taza Café Tulipán 9cl
 Tasse Café Tulipe 9cl
 Δ 110 gr A 67 mm C 77 mm L 52 mm CAP. 88 ml
 Δ ¼ lbs H 2 ¾" L 3" W 2" CAP. 3 oz

OPTIMA 21109145
 Chávena Café com Pires Oval 9cl
 Coffee Cup & Saucer Oval 9cl
 Taza Café con Platillo Oval 9cl
 Tasse et Sous-tasse Ovale Café 9cl

OPTIMA 21109147
 Pires Café Oval 9cl
 Coffee Saucer Oval 9cl
 Platillo Café Oval 9cl
 Sous-tasse Café Ovale 9cl
 Δ 104 gr A 16 mm Ø 118 mm
 Δ ¾ lbs H ¾" Ø 4 ¾"

OPTIMA 21108926
 Chávena Café com Pires Redondo 9cl
 Coffee Cup & Saucer Round 9cl
 Taza Café con Platillo Redondo 9cl
 Tasse et Sous-tasse Café Ronde 9cl

OPTIMA 21082119
 Pires Café Nemp. 9cl
 Nst. Coffee Saucer 9cl
 Platillo Café Nst. 9cl
 Sous-tasse Café Nemp. 9cl
 Δ 98 gr A 21 mm Ø 114 mm
 Δ ¾ lbs H ¾" Ø 4 ½"



OPTIMA 21108925
 Chávena Café Triangular 8cl
 Coffee Cup Triangular 8cl
 Taza Café Triangular 8cl
 Tasse Café Triangulaire 8cl
 Δ 103 gr A 71 mm C 76 mm L 57 mm CAP. 78 ml
 Δ ¾ lbs H 2 ½" L 3" W 2 ¼" CAP. 2 ¾ oz



OPTIMA 21108925
 Chávena Café Triangular 8cl
 Coffee Cup Triangular 8cl
 Taza Café Triangular 8cl
 Tasse Café Triangulaire 8cl
 Δ 103 gr A 71 mm C 76 mm L 57 mm CAP. 78 ml
 Δ ¾ lbs H 2 ½" L 3" W 2 ¼" CAP. 2 ¾ oz

OPTIMA 21109146
 Chávena Café com Pires Oval 8cl
 Coffee Cup & Saucer Oval 8cl
 Taza Café con Platillo Oval 8cl
 Tasse et Sous-tasse Café Ovale 8cl

OPTIMA 21109147
 Pires Café Oval 9cl
 Coffee Saucer Oval 9cl
 Platillo Café Oval 9cl
 Sous-tasse Café Ovale 9cl
 Δ 104 gr A 16 mm Ø 118 mm
 Δ ¾ lbs H ¾" Ø 4 ¾"

OPTIMA 21108927
 Chávena Café com Pires Redondo 8cl
 Coffee Cup & Saucer Round 8cl
 Taza Café con Platillo Redondo 8cl
 Tasse Café et Sous-tasse Ronde 8cl

OPTIMA 21082119
 Pires Café Nemp. 9cl
 Nst. Coffee Saucer 9cl
 Platillo Café Nst. 9cl
 Sous-tasse Café Nemp. 9cl
 Δ 98 gr A 21 mm Ø 114 mm
 Δ ¾ lbs H ¾" Ø 4 ½"



ORGANIC

Uma coleção única de formas peculiares, *Organic* foi concebido para a gastronomia moderna. A variedade de formas desta gama – quadradas, ovais, circulares e triangulares – permite obter inúmeras soluções inovadoras e harmoniosas de empratamentos. Criado pela equipa de Design da Vista Alegre, a filosofia do seu design assenta na assimetria das formas. Este modelo em porcelana, apropriado para buffets e para servir à mesa, constitui um estímulo à criatividade dos melhores chefs.

A unique collection of peculiar shapes, Organic was designed for modern cuisine. The variety of shapes in this range – square, oval, circular and triangular – allows for countless innovative and harmonious plate arrangements. Created by Vista Alegre's design team, the philosophy of its design is based on the asymmetry of shapes. This porcelain model, suitable either for buffets or table service, will stimulate the creativity of the best chefs.

Una colección única de formas peculiares, Organic fue creada pensando en la gastronomía moderna. La variedad de formas de esta gama – cuadradas, ovales, circulares y triangulares – permite obtener numerosas soluciones innovadoras y armoniosas de presentaciones de platos. Creada por el equipo de Diseño de Vista Alegre, la filosofía de su dibujo se basa en la asimetría de las formas. Este modelo de porcelana, apropiado para buffets y para servir a la mesa, constituye un estímulo a la creatividad de los mejores chefs.

Une collection unique aux formes particulières, Organic a été conçue pour la gastronomie moderne. La variété des formes de cette gamme – carrée, ovale, circulaire et triangulaire – permet de nombreuses présentations de plats, assez innovantes et harmonieuses. Créée par l'équipe de design de Vista Alegre, la philosophie de sa conception repose sur l'asymétrie des formes. Ce modèle en porcelaine, adapté pour le buffet et pour servir à table, est un stimulant pour la créativité des meilleurs chefs.





ORGANIC 21087656
 Travessa Oval 48
 Oval Platter 48
 Fuente Oval 48
 Plat à Servir Ovale 48
 △ 1758 gr A 36 mm C 480 mm L 292 mm
 △ 3 7/8 lbs H 1 3/4" L 18 5/8" W 11 1/2"



ORGANIC 21094085
 Travessa Triangular 40
 Triangular Platter 40
 Fuente Triangular 40
 Plat à Servir Triangulaire 40
 △ 1357 gr A 23 mm C 404 mm L 404 mm
 △ 3 lbs H 1" L 16" W 16"



ORGANIC 21094083
 Travessa Folha 36
 Leaf Platter 36
 Fuente Hoja 36
 Plat à Servir Feuille 36
 △ 938 gr A 24 mm C 364 mm L 233 mm
 △ 2 lbs H 1" L 14 1/8" W 9 1/8"



ORGANIC 21085929
 Prato Marcador 32
 Charger Plate 32
 Plato Presentación 32
 Assiette de Prêsetation 32
 △ 1388 gr A 29 mm C 327 mm L 327 mm
 △ 3 lbs H 1 1/2" L 12 7/8" W 12 7/8"



ORGANIC 21085928
 Prato Raso 28
 Dinner Plate 28
 Plato Llano 28
 Assiette Plate 28
 △ 817 gr A 22 mm Ø 279 mm
 △ 1 4/5 lbs H 5/8" Ø 11"



ORGANIC 21085925
 Prato Sopa 21
 Soup Plate 21
 Plato Hondo 21
 Assiette Creuse 21
 △ 338 gr A 43 mm C 210 mm L 145 mm CAP. 460 ml
 △ 3/4 lbs H 1 3/8" L 8 1/4" W 5 5/8" CAP. 15 5/8 oz

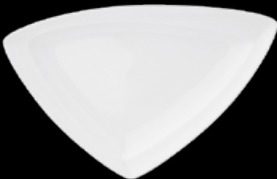

ORGANIC 21085926
 Prato Sobremesa 25
 Dessert Plate 25
 Plato Postre 25
 Assiette à Dessert 25
 △ 405 gr A 23 mm C 256 mm L 171 mm
 △ 5/8 lbs H 1" L 10" W 6 3/4"



ORGANIC 21085927
 Prato Doce 21
 Bread & Butter Plate 21
 Plato Pan 21
 Petit Assiette à Dessert 21
 △ 232 gr A 22 mm C 210 mm L 120 mm
 △ 1/2 lbs H 5/8" L 8 1/4" W 4 3/4"



ORGANIC 21090842
Saladeira Grande 25
Large Salad Bowl 25
Ensaladera Grande 25
Saladier Grand Modèle 25
△ 1217 gr A 106 mm C 254 mm
L 254 mm CAP. 3030 ml
△ 2 2/3 lbs H 4 1/8" L 10" W 10" CAP. 102 1/2 oz



ORGANIC 21094637
Saladeira Média 19
Medium Salad Bowl 19
Ensaladera Mediana 19
Saladier Moyen 19
△ 530 gr A 73 mm C 191 mm L 191 mm CAP. 1234 ml
△ 1 1/6 lbs H 2 7/8" L 7 1/2" W 7 1/2" CAP. 41 5/7 oz



ORGANIC 21094081
Saladeira Pequena 13
Small Salad Bowl 13
Ensaladera Pequeña 13
Saladier Petit Modèle 13
△ 161 gr A 45 mm C 137 mm L 137 mm CAP. 285 ml
△ 1/3 lbs H 1 7/8" L 5 3/8" W 5 3/8" CAP. 9 3/4 oz



ORGANIC 21094636
Molheira 11cl
Sauce Boat 11cl
Salsera 11cl
Saucière 11cl
△ 135 gr A 54 mm C 124 mm L 69 mm CAP. 113 ml
△ 3/7 lbs H 2 1/8" L 4 7/8" W 2 3/4" CAP. 3 5/8 oz



ORGANIC 21094078
Chávena Consomé com Pires 31cl
Consomme Cup & Saucer 31cl
Taza Consomé con Platillo 31cl
Tasse et Soucoupe Bouillon 31cl

ORGANIC 21094080
Chávena Consomé 31cl
Consomme Cup 31cl
Taza Consomé 31cl
Tasse Bouillon 31cl
△ 218 gr A 50 mm C 165 mm L 117 mm CAP. 310 ml
△ 1/2 lbs H 2" L 6 1/2" W 4 3/8" CAP. 10 1/2 oz



ORGANIC 21094082
Taça Sushi 15
Sushi Bowl 15
Taza Sushi 15
Coupelle Sushi 15
△ 114 gr A 21 mm C 153 mm L 78 mm
△ 1/4 lbs H 1 3/8" L 6" W 3"



ORGANIC 21098409
Taça Molhos 8
Sauce Bowl 8
Bowl Salsa 8
Coupelle Sauce 8
△ 67 gr A 34 mm C 80 mm L 70 mm
△ 1/4 lbs H 1 1/8" L 3 1/4" W 2 3/4"



ORGANIC 21090840
Chávena Chá com Pires 26cl
Tea Cup & Saucer 26cl
Taza Té con Platillo 26cl
Tasse et Sous-tasse Thé 26cl

ORGANIC 21091821
Chávena Chá 26cl
Tea Cup 26cl
Taza Té 26cl
Tasse Thé 26cl
△ 181 gr A 61 mm C 122 mm L 97 mm CAP. 258 ml
△ 3/5 lbs H 2 3/8" L 4 3/8" W 3 3/8" CAP. 8 5/8 oz



ORGANIC 21094073
Chávena Café com Pires 13cl
Coffee Cup & Saucer 13cl
Taza Café Cortado con Platillo 13cl
Tasse et Sous-tasse Café 13cl

ORGANIC 21094074
Chávena Café 13cl
Coffee Cup 13cl
Taza Café Cortado 13cl
Tasse Café 13cl
△ 112 gr A 51 mm C 100 mm L 75 mm CAP. 133 ml
△ 1/4 lbs H 2" L 4" W 3" CAP. 4 1/2 oz



ORGANIC 21090841
Chávena Café com Pires 8cl
Coffee Cup & Saucer 8cl
Taza Café Cortado con Platillo 8cl
Tasse et Sous-tasse Café 8cl

ORGANIC 21091823
Chávena Café 8cl
Coffee Cup 8cl
Taza Café Cortado 8cl
Tasse Café 8cl
△ 79 gr A 58 mm C 77 mm L 55 mm CAP. 81 ml
△ 1/6 lbs H 2 3/8" L 3" W 2 1/8" CAP. 2 3/4 oz

ORGANIC 21091824
Pires Café 8cl
Coffee Saucer 8cl
Platillo Café Cortado 8cl
Sous-tasse Café 8cl
△ 91 gr A 19 mm C 120 mm L 90 mm
△ 1/5 lbs H 3/4" L 4 3/8" W 3 1/2"





RIN

by Reiko Kaneko

A forma base foi inspirada nas taças cerimoniais em bronze usadas pelos monges japoneses, criando um som ressonante que acompanhava os cânticos. Nas taças *Rin* (“digno” em japonês) Vista Alegre, um ligeiro toque com uma colher permite reproduzir o som correspondente em porcelana. Mantendo uma aura espiritual, todos os cinco tamanhos possuem um pé distinto que os faz parecer flutuar sobre a mesa. Graças às dimensões cuidadosamente estudadas, cada peça desta coleção é feita para se adaptar aos gostos e hábitos de refeição modernos.

The basic shape was inspired by ceremonial Rin Bowls used by Japanese monks for their resonant sound, and all five sizes of bowl in this new collection have a distinctive foot that makes them look as if they are floating just above the table. With a carefully considered range of sizes, each bowl in the collection is made to work with our modern dining habits and taste.

La forma base se inspiró en los cuencos ceremoniales de bronce utilizados por los monjes japoneses, creando un sonido resonante que acompañaba los canticos. En cuencos Rin (“digno” en japonés) Vista Alegre un ligero toque con una cuchara permite reproducir el sonido correspondiente en porcelana. Manteniendo un aura espiritual, los cinco tamaños tienen un pie distinto que hace que parezcan flotar sobre la mesa. Gracias a las dimensiones cuidadosamente estudiadas, cada pieza de esta colección está hecha para adaptarse a los gustos y hábitos alimentarios modernos.

La forme a été inspirée des Bols de Cérémonie en bronze utilisés par les moines japonais. Leurs sons accompagnaient les cantiques. Vous retrouverez ce son en frappant les bols RIN («digne» en japonais) de Vista Alegre avec une cuillère. Chacune des 5 tailles possède une base différente qui nous laisse l'impression qu'ils lévitent sur la table, leur gardant ainsi cette aura spirituelle. Les dimensions de chaque pièce ont été soigneusement étudiées pour s'adapter aux goûts et aux habitudes de nos repas modernes.





RIN 21126245
 Tigela 27
 Bowl 27
 Taza 27
 Coupe 27
 △ 780 gr A 66 mm Ø 272 mm CAP. 1546 ml
 △ 1 5/8 lbs H 2 3/8" Ø 10 5/8" W 52 3/4 oz



RIN 21126244
 Tigela 18
 Bowl 18
 Taza 18
 Coupe 18
 △ 440 gr A 64 mm Ø 180 mm CAP. 828 ml
 △ 1 lbs H 2 1/2" Ø 7" W 28 oz



RIN 21126243
 Tigela 15
 Bowl 15
 Taza 15
 Coupe 15
 △ 375 gr A 71 mm Ø 148 mm CAP. 781 ml
 △ 3/4 lbs H 2 1/4" Ø 5 7/8" W 26 3/4 oz



RIN 21126242
 Tigela 12
 Bowl 12
 Taza 12
 Coupe 12
 △ 200 gr A 56 mm Ø 118 mm CAP. 358 ml
 △ 3/8 lbs H 2 1/8" Ø 4 3/8" W 12 1/4 oz



RIN 21126241
 Tigela 11
 Bowl 11
 Taza 11
 Coupe 11
 △ 165 gr A 50 mm Ø 105 mm CAP. 254 ml
 △ 3/8 lbs H 2" Ø 4 1/8" W 8 3/4 oz



SPIRIT HOTEL

Um modelo desenvolvido especificamente para clientes distintos de hotéis e restaurantes. *Spirit Hotel* apresenta um design moderno, com linhas curvas concêntricas que fluem ao longo de cada peça, sublinhado por um relevo sutil. A cartografia destas linhas é diferente em cada item da coleção, resultando num serviço único e harmonioso. *Spirit Hotel* foi especialmente concebido para responder às exigências de funcionalidade do dia-a-dia dos profissionais do setor, oferecendo uma linha abrangente e uma vasta seleção de acessórios de mesa.

A model developed specifically for distinguished hotel guests and restaurant customers. The Spirit Hotel features modern design, with concentric curved lines flowing throughout each piece, underlined by a subtle relief. The mapping of these lines is different for each item in the collection, resulting in a unique and harmonious table set. The Spirit Hotel was specially designed to meet the functionality requirements of day-to-day industry professionals, comprising a comprehensive range and a wide selection of tableware accessories.

Un modelo creado específicamente para ilustres clientes de hoteles y restaurantes. Spirit Hotel presenta un diseño moderno, con líneas curvas concéntricas a lo largo de cada pieza, destacado por un sutil relieve. La cartografía de estas líneas es diferente en cada pieza de la colección, resultando en una vajilla única y armoniosa. Spirit Hotel ha sido diseñado para el exigente uso diario y funcional de los profesionales del sector, ofreciendo una línea amplia y una gran selección de accesorios de mesa.

Un modèle spécifiquement développé pour les clients d'hôtels et de restaurants. Spirit Hotel révèle un design moderne, avec des lignes courbes concentriques qui se prolongent tout au long de chaque pièce, souligné par un relief subtil. La cartographie de ces lignes est différente pour chaque pièce de la collection, le résultat étant un service unique et harmonieux. Spirit Hotel a été spécialement conçu pour répondre aux exigences de fonctionnalité du quotidien des professionnels du secteur, offrant une gamme complète et une large sélection d'accessoires de table.





SPIRIT HOTEL 21002756
 Travessa Oval Grande 43
Large Oval Platter 43
Fuente Oval Grande 43
Plat à Servir Ovale Grand Modèle 43
 △ 1842 gr A 33 mm C 430 mm L 328 mm
 △ 4 lbs H 1 3/4" L 17" W 13"



SPIRIT HOTEL 21002757
 Travessa Oval Média 37
Medium Oval Platter 37
Fuente Oval Mediana 37
Plat à Servir Ovale Moyen 37
 △ 1373 gr A 29 mm C 371 mm L 284 mm
 △ 3 lbs H 1 1/2" L 14 3/8" W 11 1/8"



SPIRIT HOTEL 21002758
 Travessa Oval Pequena 33
Small Oval Platter 33
Fuente Oval Pequena 33
Plat à Servir Ovale Petit Modèle 33
 △ 898 gr A 28 mm C 328 mm L 251 mm
 △ 2 lbs H 1 1/8" L 13" W 9 7/8"



SPIRIT HOTEL 21002759
 Prato Redondo Raso 34
Flat Round Platter 34
Fuente Redonda Llana 34
Assiette Plate Ronde 34
 △ 1311 gr A 32 mm Ø 336 mm
 △ 2 3/4 lbs H 1 1/4" Ø 13 3/8"



SPIRIT HOTEL 21002760
 Travessa Redonda Funda 33
Deep Round Platter 33
Fuente Redonda Honda 33
Plat à Servir Creux Rond 33
 △ 1405 gr A 53 mm Ø 330 mm CAP. 1345 ml
 △ 3 lbs H 2" Ø 13" CAP. 45 1/2 oz

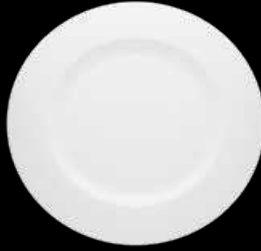

SPIRIT HOTEL 21102323
 Prato Marcador 32
Charger Plate 32
Plato Presentación 32
Assiette de Présentation 32
 △ 1146 gr A 24 mm Ø 321 mm
 △ 2 1/2 lbs H 1" Ø 12 3/8"



SPIRIT HOTEL 21096372
 Prato Raso 29,5
Dinner Plate 29,5
Plato Llano 29,5
Assiette Plate 29,5
 △ 942 gr A 23 mm Ø 296 mm
 △ 2 lbs H 1" Ø 11 3/8"



SPIRIT HOTEL 21096371
 Prato Raso 28
Dinner Plate 28
Plato Llano 28
Assiette Plate 28
 △ 776 gr A 23 mm Ø 275 mm
 △ 1 3/4 lbs H 1" Ø 10 5/8"



SPIRIT HOTEL 21107552
 Prato Raso 25
Dinner Plate 25
Plato Llano 25
Assiette Plate 25
 △ 589 gr A 22 mm Ø 249 mm
 △ 1 3/4 lbs H 9/8" Ø 9 7/8"



SPIRIT HOTEL 21002761
 Prato Pasta Grande 32
Large Pasta Plate 32
Plato Pasta Grande 32
Assiette à Pâtes Grand Modèle 32
 △ 1176 gr A 69 mm Ø 320 mm CAP. 990 ml
 △ 2 3/8 lbs H 2 3/4" Ø 12 3/8" CAP. 33 1/2 oz



SPIRIT HOTEL 21002762
 Prato Pasta Pequeno 24
Small Pasta Plate 24
Plato Pasta Pequeno 24
Assiette à Pâtes Petit Modèle 32
 △ 618 gr A 58 mm Ø 244 mm CAP. 457 ml
 △ 1 1/4 lbs H 2 3/4" Ø 9 3/8" CAP. 15 3/4 oz



SPIRIT HOTEL 21096373
 Prato Sopa 23
Soup Plate 23
Plato Hondo 23
Assiette Creuse 23
 △ 499 gr A 32 mm Ø 233 mm CAP. 256 ml
 △ 1 1/4 lbs H 1 1/4" Ø 9 1/8" CAP. 8 3/4 oz



SPIRIT HOTEL 21096370
 Prato Sobremesa 21
Dessert Plate 21
Plato Postre 21
Assiette à Dessert 21
 △ 407 gr A 19 mm Ø 212 mm
 △ 3/8 lbs H 3/4" Ø 8 1/2"



SPIRIT HOTEL 21096369
 Prato Doce 17
Bread & Butter Plate 17
Plato Pan 17
Petit Assiette à Dessert 17
 △ 236 gr A 19 mm Ø 166 mm
 △ 1/2 lbs H 3/4" Ø 6 1/2"



SPIRIT HOTEL 21002755
 Conserveira
Olive Dish
Rabanera
Ravier
 △ 200 gr A 26 mm C 151 mm L 151 mm
 △ 3/8 lbs H 1" L 6" W 6"



SPIRIT HOTEL 21002752
 Terrina 348cl
Tureen 348cl
Sopera 348cl
Soupière 348cl
 △ 2194 gr A 183 mm Ø 288 mm CAP. 3479 ml
 △ 4 3/4 lbs H 7 1/2" Ø 11 1/2" CAP. 117 2/3 oz



SPIRIT HOTEL 21002753
Saladeira 23
Salad Bowl 23
Ensaladera 23
Saladier 23
△ 1024 gr A 108 mm Ø 238 mm CAP. 2774 ml
△ 2 ¼ lbs H 4 ¼" Ø 9 ¾" CAP. 93 ½ oz



SPIRIT HOTEL 21096377
Chávena Consomé com Pires 35cl
Consomme Cup & Saucer 35cl
Taza Consome con Platico 35cl
Tasse et Soucoupe Bouillon 35cl

SPIRIT HOTEL 21096363
Chávena Consomé 35cl
Consomme Cup 35cl
Taza Consome 35cl
Tasse Bouillon 35cl
△ 215 gr A 52 mm C 160 mm L 125 mm CAP. 353 ml
△ ½ lbs H 2" L 6 ¾" W 5" CAP. 12 oz



SPIRIT HOTEL 21002754
Molheira com Prato 40cl
Sauceboat & Stand 40cl
Salsera con Platico 40cl
Saucière avec Soucoupe 40cl
△ 330 gr A 70 mm C 186 mm L 113 mm CAP. 400 ml
△ ¾ lbs H 2 ¾" L 7 ½" W 4 ½" CAP. 13 ½ oz



SPIRIT HOTEL 21096374
Tigela Cereais 17,5
Cereal Bowl 17,5
Bowl Cereales 17,5
Col Céréales 17,5
△ 330 gr A 49 mm Ø 175 mm CAP. 586 ml
△ ¾ lbs H 2" Ø 6 ¾" CAP. 19 ½ oz

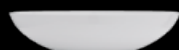

SPIRIT HOTEL 21002750
Tigela Cereais 17
Cereal Bowl 17
Bowl Cereales 17
Col Céréales 17
△ 303 gr A 48 mm Ø 172 mm CAP. 569 ml
△ ¾ lbs H 1 ¾" Ø 6 ¾" CAP. 19 ¼ oz

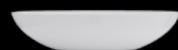

SPIRIT HOTEL 21105895
Tigela Cereais 14
Cereal Bowl 14
Bowl Cereales 14
Col Céréales 14
△ 233 gr A 41 mm Ø 144 mm CAP. 321 ml
△ ½ lbs H 1 ¾" Ø 5 ¾" CAP. 10 ¾ oz



SPIRIT HOTEL 21002763
Leiteira Grande 31cl
Large Milk Jug 31cl
Lechera Grande 31cl
Crémier Grand Modèle 31cl
△ 263 gr A 95 mm C 142 mm L 86 mm CAP. 305 ml
△ ½ lbs H 3 ¾" L 5 ¾" W 3 ¾" CAP. 10 ½ oz



SPIRIT HOTEL 21096365
Leiteira Pequena 14cl
Small Milk Jug 14cl
Lechera Pequeña 14cl
Crémier Petit Modèle 14cl
△ 152 gr A 70 mm C 109 mm L 66 mm CAP. 135 ml
△ ½ lbs H 2 ¾" L 4 ¾" W 2 ¾" CAP. 4 ½ oz



SPIRIT HOTEL 21002764
Açucareiro
Sugar Bowl
Azucarero
Sucrier
△ 349 gr A 111 mm Ø 106 mm CAP. 409 ml
△ ¾ lbs H 4 ¾" Ø 4 ½" CAP. 13 ¾ oz



SPIRIT HOTEL 21002765
Bule 130cl
Tea Pot 130cl
Tetera 130cl
Théière 130cl
△ 996 gr A 148 mm C 263 mm
L 162 mm CAP. 1294 ml
△ 2 ½ lbs H 5 ¾" L 10 ½" W 6 ¾" CAP. 43 ¾ oz



SPIRIT HOTEL 21096380
Bule 40cl
Tea Pot 40cl
Tetera 40cl
Théière 40cl
△ 483 gr A 106 mm C 170 mm L 105 mm CAP. 452 ml
△ 1 lbs H 4 ½" L 6 ¾" W 4 ½" CAP. 15 ¾ oz



SPIRIT HOTEL 21002766
Cafeteira 125cl
Coffee Pot 125cl
Cafetera 125cl
Cafetière 125cl
△ 872 gr A 188 mm C 236 mm L 134 mm CAP. 1246 ml
△ 2 lbs H 7 ¾" L 9 ¾" W 5 ¾" CAP. 42 ½ oz



SPIRIT HOTEL 21096381
Cafeteira 40cl
Coffee Pot 40cl
Cafetera 40cl
Cafetière 40cl
△ 433 gr A 134 mm C 157 mm L 86 mm CAP. 425 ml
△ 1 lbs H 5 ¾" L 6 ½" W 3 ¾" CAP. 14 ¾ oz



SPIRIT HOTEL 21096378
Chávena Pequeno Almoço com Pires 35cl
Breakfast Cup & Saucer 35cl
Taza Desayuno con Platico 35cl
Tasse et Sous-tasse Petit Déjeuner 35cl

SPIRIT HOTEL 21096364
Chávena Pequeno Almoço 35cl
Breakfast Cup 35cl
Taza Desayuno 35cl
Tasse Petit Déjeuner 35cl
△ 290 gr A 64 mm C 137 mm L 107 mm CAP. 346 ml
△ ¾ lbs H 2 ½" L 5 ¾" W 4 ½" CAP. 11 ¾ oz

SPIRIT HOTEL 21096368
Pires Consomé/ Pequeno Almoço
Consomme/ Breakfast Saucer
Platico Consome/ Desayuno
Soucoupe Bouillon/ Petit Déjeuner
△ 259 gr A 23 mm Ø 170 mm
△ ½ lbs H 1" Ø 6 ¾"





SPIRIT HOTEL 21096376
Chávena Chá com Pires 23cl
Tea Cup & Saucer 23cl
Taza Té con Platillo 23cl
Tasse et Sous-tasse Thé 23cl

SPIRIT HOTEL 21096362
Chávena Chá 23cl
Tea Cup 23cl
Taza Té 23cl
Tasse Thé 23cl
△ 203 gr A 64 mm C 118 mm L 89 mm CAP. 233 ml
△ ¾ lbs H 2 ½" L 4 ¾" W 3 ½" CAP. 7 ¾ oz



SPIRIT HOTEL 21096379
Chávena Café com Pires 13cl
Coffee Cup & Saucer 13cl
Taza Café Cortado con Platillo 13cl
Tasse et Sous-tasse Café 13cl

SPIRIT HOTEL 21096382
Chávena Café 13cl
Coffee Cup 13cl
Taza Café Cortado 13cl
Tasse Café 13cl
△ 167 gr A 56 mm C 100 mm L 77 mm CAP. 142 ml
△ ¾ lbs H 2 ½" L 4" W 3" CAP. 4 ¾ oz

SPIRIT HOTEL 21096367
Pires Chá
Tea Cup Saucer
Platillo Taza Té
Sous-tasse Thé
△ 215 gr A 22 mm Ø 158 mm
△ ½ lbs H ¾" Ø 6 ¾"

SPIRIT HOTEL 21096383
Pires Café 13cl
Coffee Saucer 13cl
Platillo Café Cortado 13cl
Sous-tasse Café 13cl
△ 179 gr A 21 mm Ø 148 mm
△ ¾ lbs H ¾" Ø 5 ¾"



SPIRIT HOTEL 21096375
Chávena Café com Pires 9cl
Coffee Cup & Saucer 9cl
Taza Café Cortado con Platillo 9cl
Tasse et Sous-tasse Café 19cl

SPIRIT HOTEL 21096361
Chávena Café 9cl
Coffee Cup 9cl
Taza Café Cortado 9cl
Tasse Café 19cl
△ 114 gr A 52 mm C 89 mm L 65 mm CAP. 90 ml
△ ¼ lbs H 2" L 3 ½" W 2 ¾" CAP. 3 oz

SPIRIT HOTEL 21096366
Pires Café 9cl
Coffee Saucer 9cl
Platillo Café 9cl
Sous-tasse Café 19cl
△ 118 gr A 18 mm Ø 116 mm
△ ¼ lbs H ¾" Ø 5 ¼"



SPIRIT HOTEL 21002767
Chávena Pequeno Almoço Nemp
Nst Breakfast Cup
Taza Desayuno Nst
Tasse Petit Déjeuner Nemp
△ 453 gr A 72 mm Ø 170 mm CAP. 435 ml
△ 1 lbs H 2 ¾" Ø 6 ¾" CAP. 14 ¾ oz



SPIRIT HOTEL 21002768
Chávena Chá Nemp
Nst Tea Cup
Taza Té Nst
Tasse Thé Nemp
△ 378 gr A 66 mm C 157 mm CAP. 267 ml
△ ¾ lbs H 2 ¾" L 6 ½" CAP. 9 oz



SPIRIT HOTEL 21002769
Chávena Café Nemp
Nst Coffee Cup
Taza Café Nst
Tasse Café Nemp
△ 170 gr A 46 mm C 113 mm CAP. 88 ml
△ ¾ lbs H 1 ¾" L 4 ¾" CAP. 3 oz





SYNERGY

Para que inicie o seu dia de forma inspiradora sugerimos-lhe uma sinergia excepcional de elementos. Bom gosto, funcionalidade, resistência e modernidade. Nunca o chá ou o café tiveram tanto charme.

For an inspiring start to your day, we suggest an exceptional synergy of elements. Good taste, functionality, toughness and modernity. Your tea or coffee have never shown more charm.

Para que comience su día de forma inspiradora le sugerimos una sinergia excepcional de elementos. Buen gusto, funcionalidad, resistencia y modernidad. Tomar el té o el café nunca había tenido tanto estilo.

Pour un début de journée inspirant, nous vous suggérons une synergie exceptionnelle d'éléments. Le bon goût, la fonctionnalité, la résistance et la modernité. Le thé ou le café n'ont jamais eu autant de charme.





SYNERGY 21107727
 Molheira com Prato 21cl
 Sauceboat & Stand 21cl
 Salsera con Platillo 21cl
 Saucière avec Soucoupe 21cl

SYNERGY 21107726
 Molheira 21cl
 Sauceboat 21cl
 Salsera 21cl
 Saucière 21cl
 △ 209 gr A 77 mm C 129 mm
 L 73 mm CAP. 218 ml
 △ ½ lbs H 3" L 5" W 2 7/8" CAP. 7 3/8 oz



SYNERGY 21107475
 Leiteira Grande 30cl
 Large Milk Jug 30cl
 Lechera Grande 30cl
 Crémier Grand Modèle 30cl
 △ 269 gr A 96 mm C 112 mm
 L 66 mm CAP. 297 ml
 △ 3/8 lbs H 3 3/8" L 4 3/8" W 2 3/8" CAP. 10 oz



SYNERGY 21107474
 Leiteira Pequena 12,5cl
 Small Milk Jug 12,5cl
 Lechera Pequeña 12,5cl
 Crémier Petit Modèle 12,5cl
 △ 150 gr A 75 mm C 85 mm
 L 51 mm CAP. 124 ml
 △ 1/8 lbs H 3" L 3 1/8" W 2" CAP. 4 1/8 oz



SYNERGY 21107478
 Açucareiro Pacotes
 Sugar Box
 Azucarero Paquetes
 Sucrier Sachets de Sucre
 △ 190 gr A 69 mm C 117 mm
 L 68 mm CAP. 199 ml
 △ 3/8 lbs H 2 3/8" L 4 3/8" W 2 3/8" CAP. 6 3/4 oz



SYNERGY 21107467
 Bule Grande 90cl
 Large Tea Pot 90cl
 Tetera Grande 90cl
 Thêière Grand Modèle 90cl
 △ 798 gr A 145 mm C 219 mm
 L 109 mm CAP. 926 ml
 △ 1 3/4 lbs H 5 3/8" L 8 3/8" W 4 3/8" CAP. 31 1/3 oz



SYNERGY 21107471
 Bule Pequeno 40cl
 Small Tea Pot 40cl
 Tetera Pequeño 40cl
 Thêière Petit Modèle 40cl
 △ 491 gr A 126 mm C 180 mm
 L 87 mm CAP. 455 ml
 △ 1 lbs H 5" L 7" W 3 3/8" CAP. 15 3/8 oz



SYNERGY 21107472
 Cafeteira Grande 90cl
 Large Coffee Pot 90cl
 Cafetera Grande 90cl
 Cafetière Grand Modèle 90cl
 △ 735 gr A 191 mm C 100 mm
 L 75 mm CAP. 945 ml
 △ 1 5/8 lbs H 7 1/2" L 4" W 3" CAP. 32 oz



SYNERGY 21107473
 Cafeteira Pequeno 40cl
 Small Coffee Pot 40cl
 Cafetera Pequeño 40cl
 Cafetière Petit Modèle 40cl
 △ 448 gr A 159 mm C 147 mm
 L 69 mm CAP. 419 ml
 △ 1 lbs H 6 1/4" L 5 9/8" W 2 5/8" CAP. 14 1/6 oz



SYNERGY 21107960
 Caneca 40cl
 Mug 40cl
 Mug 40cl
 Mug 40cl
 △ 334 gr A 111 mm C 125 mm
 L 97 mm CAP. 396 ml
 △ 3/4 lbs H 4 3/8" L 5" W 3 3/8" CAP. 13 2/5 oz



SYNERGY 21107480
 Chávena Pequeno Almoço
 com Pires 33cl
 Breakfast Cup & Saucer 33cl
 Taza Desayuno con Platillo 33cl
 Tasse et Sous-tasse Petit
 Déjeuner 33cl

SYNERGY 21107479
 Chávena Pequeno Almoço 33cl
 Breakfast Cup 33cl
 Taza Desayuno 33cl
 Tasse Petit Déjeuner 33cl
 △ 273 gr A 77 mm C 136 mm
 L 110 mm CAP. 334 ml
 △ 3/8 lbs H 3" L 5 1/8" W 4 1/8" CAP. 11 2/7 oz



SYNERGY 21107722
 Chávena Chá com Pires 21cl
 Tea Cup & Saucer 21cl
 Taza Té con Platillo 21cl
 Tasse et Sous-tasse Thé 21cl

SYNERGY 21107721
 Chávena Chá 21cl
 Tea Cup 21cl
 Taza Té 21cl
 Tasse Thé 21cl
 △ 192 gr A 65 mm C 117 mm
 L 95 mm CAP. 210 ml
 △ 3/8 lbs H 2 3/8" L 4 3/8" W 3 3/4" CAP. 7 1/8 oz



SYNERGY 21107476
 Saleiro
 Salt
 Salero
 Salière
 △ 83gr A 79 mm C 53 mm L 52 mm
 △ 1/8 lbs H 3 1/8" L 2" W 2"



SYNERGY 21109016
 Chávena Café com Pires 13cl
 Coffee Cup & Saucer 13cl
 Taza Café Cortado con Platillo 13cl
 Tasse et Sous-tasse Café 13cl

SYNERGY 21108002
 Chávena Café 13cl
 Coffee Cup 13cl
 Taza Café Cortado 13cl
 Tasse Café 13cl
 △ 139 gr A 61 mm C 98 mm
 L 79 mm CAP. 127 ml
 △ 1/8 lbs H 2 3/8" L 3 3/8" W 3 1/8" CAP. 4 3/7 oz



SYNERGY 21107720
 Chávena Café com Pires 9cl
 Coffee Cup & Saucer 9cl
 Taza Café Cortado con Platillo 9cl
 Tasse et Sous-tasse Café 9cl

SYNERGY 21107719
 Chávena Café 9cl
 Coffee Cup 9cl
 Taza Café Cortado 9cl
 Tasse Café 9cl
 △ 108 gr A 63 mm C 82 mm
 L 63 mm CAP. 84 ml
 △ 1/4 lbs H 2 1/2" L 3 3/8" W 2 1/2" CAP. 2 3/8 oz



SYNERGY 21107477
 Pimenteiro
 Pepper
 Pimentero
 Poivrière
 △ 83gr A 79 mm C 53 mm L 52 mm
 △ 1/8 lbs H 3 1/8" L 2" W 2"



TAPAS & SUSHI

Com combinações versáteis e linhas contemporâneas, a coleção *Tapas & Sushi* intensifica a exuberância dos sabores e induz sensações fortes. Deixe-se conduzir pelo prazer da degustação e da criatividade. A sua imaginação é o limite.

With versatile combinations and a contemporary shape, Tapas & Sushi Collection allows the enjoyment of the exuberant flavours and induces intensive sensations. Let yourself be carried by the pleasure of taste and creativity. The limit is your imagination.

Con combinaciones versátiles y líneas contemporáneas, la colección Tapas & Sushi permite disfrutar de la exuberancia de los sabores e inducir sensaciones intensas. Déjese llevar por el placer de la degustación y la creatividad, el limite es su imaginación.

Avec des combinaisons de lignes souples et contemporaines, la collection Tapas & Sushi intensifie l'exubérance de saveurs et induit des sensations fortes. Laissez-vous guider par le plaisir de la dégustation et de la créativité. Votre imagination est la limite.



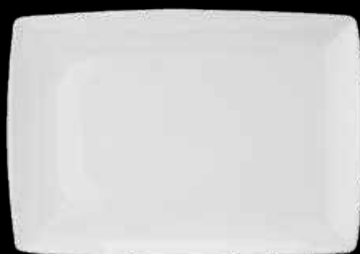

TAPAS & SUSHI 21090488
Travessa Rectangular Grande 38
Rectangular Platter 38
Fuente Rectangular 38
Plat à Servir Rectangulaire Grand Modèle 38
△ 1597 gr A 29 mm C 384 mm L 383 mm
△ 3 1/2 lbs H 1 1/2" L 15 1/8" W 15"



TAPAS & SUSHI 21083886
Prato Rectangular Grande 27
Large Rectangular Plate 27
Plato Rectangular Grande 27
Grande Assiette Rectangulaire 27
△ 777 gr A 30 mm C 274 mm L 191 mm
△ 1 3/4 lbs H 1 1/8" L 10 3/8" W 7 1/2"



TAPAS & SUSHI 21098407
Prato Rectangular Pequeno 21
Small Rectangular Plate 21
Plato Rectangular Pequeño 21
Petit Assiette Rectangulaire 21
△ 397 gr A 30 mm C 212 mm L 129 mm
△ 7/8 lbs H 1 1/8" L 8 1/8" W 5"



TAPAS & SUSHI 21100714
Prato Rectangular 14
Rectangular Plate 14
Plato Rectangular 14
Assiette Rectangulaire 14
△ 218 gr A 21 mm C 140 mm L 110 mm
△ 1/2 lbs H 3/8" L 5 1/2" W 4 1/8"



TAPAS & SUSHI 21100715
Prato Quente 16
Hot Dish 16
Plato Caliente 16
Assiette Chauffante 16
△ 268 gr A 27 mm C 159 mm L 159 mm
△ 3/8 lbs H 1" L 6 1/4" W 6 1/4"



TAPAS & SUSHI 21098406
Prato Quadrado 13
Square Plate 13
Plato Cuadrado 13
Assiette Carrée 13
△ 197 gr A 28 mm C 129 mm L 129 mm
△ 3/8 lbs H 1 1/8" L 5" W 5"



TAPAS & SUSHI 21100716
Taça Sobremesa 11
Dessert Bowl 11
Bowl Postre 11
Coupe Dessert 11
△ 150 gr A 42 mm C 107 mm L 107 mm CAP. 246 ml
△ 1/8 lbs H 1 3/8" L 4 1/8" W 4 1/8" CAP. 8 1/2 oz



TAPAS & SUSHI 21094088
Bandeja Baguete 32
Baguete Tray 32
Fuente Baguete 32
Plat Baguettes 32
△ 639 gr A 28 mm C 323 mm L 145 mm
△ 1 3/8 lbs H 1 1/8" L 12 3/8" W 5 3/8"



TAPAS & SUSHI 21100713
Tigela Redonda 15
Round Bowl 15
Bowl Redonda 15
Coupelle Ronde 15
△ 218 gr A 42 mm ∅ 148 mm
△ 1/2 lbs H 1 3/8" ∅ 5 3/8"



TAPAS & SUSHI 21090487
Bandeja 19
Tray 19
Fuente 19
Plateau 19
△ 200 gr A 23 mm C 190 mm L 88 mm
△ 4/8 lbs H 1" L 7 1/2" W 3 1/2"



TAPAS & SUSHI 21094116
Taça Sushi 9
Sushi Bowl 9
Taza Sushi 9
Coupelle Sushi 9
△ 114 gr A 36 mm C 86 mm L 86 mm
1/4 lbs H 1 3/8" L 3 3/8" W 3 3/8"



TAPAS & SUSHI 21094081
Saladeira Pequena 13
Small Salad Bowl 13
Ensaladera Pequeña 13
Saladier Petit Modèle 13
△ 158 gr A 46 mm C 133 mm L 133 mm
△ 1/2 lbs H 1 3/8" L 5 1/4" W 5 1/4"



TAPAS & SUSHI 21098408
Prato Degustação Azeite
Olive Oil Tasting Dish
Plato Degustación Aceite Oliva
Assiette Dégustation Huile d'Olive
△ 158 gr A 25 mm C 106 mm L 106 mm
△ 1/3 lbs H 1" L 4 1/8" W 4 1/8"



TAPAS & SUSHI 21098405
Colher Degustação
Tasting Spoon
Cuchara Degustación
Cuillère Dégustation
△ 51 gr A 70 mm C 106 mm L 106 mm
△ 1/9 lbs H 2 3/4" L 4 1/8" W 4 1/8"



TAPAS & SUSHI 21097651
Bandeja Caneca 22
Mug Tray 22
Fuente Mug 22
Grande Sous-tasse Mug 22
△ 431 gr A 26 mm C 221 mm L 149 mm
△ 1 lbs H 1" L 8 5/8" W 5 5/8"



TAPAS & SUSHI 21098409
Taça Molhos 7
Sauce Bowl 7
Bowl Salsa 7
Coupelle Sauce 7
△ 69 gr A 35 mm C 69 mm L 69 mm
△ 1/2 lbs H 1 3/8" L 2 5/8" W 2 5/8"



TAPAS & SUSHI 21100717
Manteigueira
Butter Dish
Bowl Mantequilla
Beurrier

△ 44 gr A 33 mm Ø 60 mm CAP. 46 ml
△ 1/10 lbs H 1 3/4" Ø 2 1/2" CAP. 1 5/8 oz



TAPAS & SUSHI 21098404
Taça Tapas 17
Tapas Bowl 17
Bowl Tapas 17
Coupelle Tapas 17

△ 446 gr A 79 mm Ø 162 mm CAP. 914 ml
△ 1 lbs H 3 1/8" Ø 6 3/8" CAP. 31 oz



TAPAS & SUSHI 21098403
Taça Tapas 13
Tapas Bowl 13
Bowl Tapas 13
Coupelle Tapas 13

△ 230 gr A 64 mm Ø 130 mm CAP. 467 ml
△ 1/2 lbs H 2 1/2" Ø 5 1/8" CAP. 15 4/5 oz



TAPAS & SUSHI 21098402
Taça Tapas 10
Tapas Bowl 10
Bowl Tapas 10
Coupelle Tapas 10

△ 137 gr A 50 mm Ø 100 mm CAP. 195 ml
△ 1/5 lbs H 2" Ø 4" CAP. 6 3/5 oz



TAPAS & SUSHI 21098401
Taça Tapas 7
Tapas Bowl 7
Bowl Tapas 7
Coupelle Tapas 7

△ 66 gr A 39 mm Ø 71 mm CAP. 77 ml
△ 1/7 lbs H 1 1/2" Ø 2 3/4" CAP. 2 3/5 oz



TAPAS & SUSHI 21098400
Taça Tapas 5
Tapas Bowl 5
Bowl Tapas 5
Coupelle Tapas 5

△ 37 gr A 33 mm Ø 51 mm CAP. 35 ml
△ 1/10 lbs H 1 3/4" Ø 2" CAP. 1 1/5 oz



TAPAS & SUSHI 21090483
Taça Cubo 5
China Cube 5
Bowl Cubo 5
Coupelle Cube 5

△ 80 gr A 40 mm C 50 mm L 50 mm
△ 1/6 lbs H 1 1/2" L 2" W 2"



TAPAS & SUSHI 21094082
Taça Sushi 15
Sushi Bowl 15
Taza Sushi 15
Coupelle Sushi 15

△ 114 gr A 21 mm C 153 mm L 78 mm
△ 1/4 lbs H 1 3/8" L 6" W 3"



TAPAS & SUSHI BLACK 38001754
Taça Tapas 17
Tapas Bowl 17
Bowl Tapas 17
Coupelle Tapas 17

△ 446 gr A 79 mm Ø 162 mm CAP. 914 ml
△ 1 lbs H 3 1/8" Ø 6 3/8" CAP. 31 oz



TAPAS & SUSHI BLACK 38001753
Taça Tapas 13
Tapas Bowl 13
Bowl Tapas 13
Coupelle Tapas 13

△ 230 gr A 64 mm Ø 130 mm CAP. 467 ml
△ 1/2 lbs H 2 1/2" Ø 5 1/8" CAP. 15 4/5 oz



TAPAS & SUSHI BLACK 38001752
Taça Tapas 10
Tapas Bowl 10
Bowl Tapas 10
Coupelle Tapas 10

△ 137 gr A 50 mm Ø 100 mm CAP. 195 ml
△ 1/5 lbs H 2" Ø 4" CAP. 6 3/5 oz



TAPAS & SUSHI BLACK 38001751
Taça Tapas 7
Tapas Bowl 7
Bowl Tapas 7
Coupelle Tapas 7

△ 66 gr A 39 mm Ø 71 mm CAP. 77 ml
△ 1/7 lbs H 1 1/2" Ø 2 3/4" CAP. 2 3/5 oz



TAPAS & SUSHI BLACK 38001750
Taça Tapas 5
Tapas Bowl 5
Bowl Tapas 5
Coupelle Tapas 5

△ 37 gr A 33 mm Ø 51 mm CAP. 35 ml
△ 1/10 lbs H 1 3/4" Ø 2" CAP. 1 1/5 oz



TAPAS & SUSHI BLACK 38001755
Taça Sushi Quadrada 9
Square Sushi Bowl 9
Taza Sushi Cuadrada 9
Coupelle Sushi Carré 9

△ 115 gr A 36 mm C 86 mm L 86 mm CAP. 125 ml
△ 1/4 lbs H 1 3/4" L 3 3/5" W 3 3/5" CAP. 4 2/5 ml



TAPAS & SUSHI BLACK 38001756
Taça Sushi 15
Sushi Bowl 15
Taza Sushi 15
Coupelle Sushi 15

△ 114 gr A 21 mm C 153 mm L 78 mm
△ 1/4 lbs H 3/8" L 6" W 3"





UTOPIA



reddot award 2018
winner



Cada peça de *Utopia* apresenta uma construção de relevos diferentes que se adapta à forma, influenciada por geometrias orientais, realçando-a e conferindo-lhe dinamismo. O relevo é inspirado nos plissados aplicados aos origami, arte secular japonesa em papel. Um conjunto onde predominam as curvas fluidas e elegantes, a delicadeza e a poesia.

Each piece of the set Utopia displays a construction of different reliefs inspired by Japanese geometries which adapts to the shape, highlighting each piece and giving it momentum. The relief is inspired by ruffles applied to origami, the secular Japanese art of paper folding. A set where fluid and elegant curves delicacy and poetry prevail.

Las geometrías japonesas y los pliegues de papel del origami –antigua arte japonesa– sirven de inspiración a la colección Utopía, donde cada pieza presenta una composición de diferentes relieves que se adaptan a la forma, realizándola y dándole mayor dinamismo. Un conjunto donde predominan las curvas fluidas y elegantes, la delicadeza y la poesía.

Chaque Pièce de la Collection Utopia a un relief différent qui se confond avec sa forme. Inspiré de l'art du plissage japonais –l'origami– cette géométrie de relief donne à cette collection du dynamisme, où les courbes sont fluides, élégantes, délicates et poétiques.



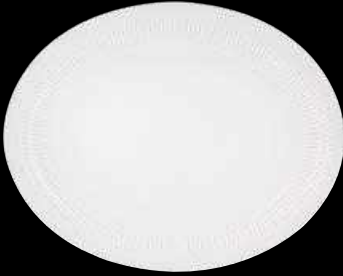

UTOPIA 21127759
Travessa Oval 35
Oval Platter 35
Fuente Oval 35
Plat à Servir Ovale 35
△ 1113 gr A 33 mm C 348 mm L 278 mm
△ 2 4/9 lbs H 1 3/4" L 13 5/8" W 11"

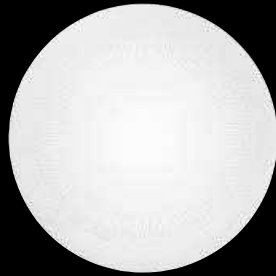

UTOPIA 21127753
Prato Marcador 32
Charger Plate 32
Plato Presentación 32
Assiette de Présentation 32
△ 1035 gr A 27 mm Ø 320 mm
△ 2 3/7 lbs H 1 1/8" Ø 12 3/8"



UTOPIA 21127754
Prato Raso 29
Dinner Plate 29
Plato Llano 29
Assiette Plate 29
△ 825 gr A 27 mm Ø 288 mm
△ 1 3/6 lbs H 1 1/8" Ø 11 1/8"



UTOPIA 21131066
Prato Raso 27
Dinner Plate 27
Plato Llano 27
Assiette Plate 27
△ 685 gr A 24 mm Ø 270 mm
△ 1 1/2 lbs H 1" Ø 10 5/8"



UTOPIA 21127758
Prato Pasta 28
Pasta Plate 28
Plato Pasta 28
Assiette à Pâtes 28
△ 720 gr A 58 mm Ø 277 mm
△ 1 3/6 lbs H 2 3/4" Ø 10 9/8"



UTOPIA 21127755
Prato Sopa 27
Soup Plate 27
Plato Hondo 27
Assiette Creuse 27
△ 715 gr A 56 mm Ø 267 mm
△ 1 4/7 lbs H 2 1/8" Ø 10 1/2"

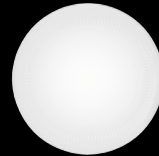

UTOPIA 21127756
Prato Sobremesa 23
Dessert Plate 23
Plato Postre 23
Assiette à Dessert 23
△ 448 gr A 21 mm Ø 228 mm
△ 1 lbs H 5/8" Ø 9"



UTOPIA 21127757
Prato Pão 17
Bread & Butter Plate 17
Plato Pan 17
Assiette à Pain 17
△ 219 gr A 18 mm Ø 170 mm
△ 1/2 lbs H 5/8" Ø 6 5/8"



UTOPIA 21127760
Saladeira 22
Salad Bowl 22
Ensaladera 22
Saladier 22
△ 782 gr A 114 mm Ø 222 mm CAP. 2200 ml
△ 1 3/6 lbs H 4 1/2" Ø 8 3/4" CAP. 74 2/5 oz



UTOPIA 21127761
Tigela Cereais 16
Cereal Bowl 16
Bowl Cereales 16
Bol Céréales 16
△ 335 gr A 75 mm Ø 160 mm CAP. 795 ml
△ 3/4 lbs H 3" Ø 6 3/8" CAP. 26 3/8 oz



UTOPIA 21127762
Tigela Individual 11
Individual Bowl 11
Bowl 11
Bol Individuel 11
△ 154 gr A 58 mm Ø 108 mm CAP. 239 ml
△ 1/3 lbs H 2 3/4" Ø 4 1/4" CAP. 8 1/8 oz



UTOPIA 21128448
Bule Grande 132cl
Large Tea Pot 132cl
Tetera Grande 132cl
Théière Grand Modèle 132cl
△ 718 gr A 110 mm C 254 mm L 180 mm CAP. 1320 ml
△ 1 4/7 lbs H 4 1/8" L 10" W 7 3/8" CAP. 44 3/8 oz



UTOPIA 21128449
Bule Pequeno 48cl
Small Tea Pot 48cl
Tetera Pequeña 48cl
Théière Petit Modèle 48cl
△ 409 gr A 88 mm C 197 mm L 129 mm CAP. 480 ml
△ 8/9 lbs H 3 3/8" L 7 3/4" W 5 1/8" CAP. 16 2/5 oz



UTOPIA 21127767
Leiteira 26cl
Milk Jug 26cl
Lechera 26cl
Crémier 26cl
△ 204 gr A 131 mm C 79 mm L 75 mm CAP. 259 ml
△ 4/9 lbs H 5 1/8" L 3 1/8" W 3" CAP. 8 3/4 oz



UTOPIA 21127766
Açucareiro
Sugar Bowl
Azucarero
Sucrier
△ 332 gr A 83 mm Ø 118 mm CAP. 363 ml
△ 3/7 lbs H 3 1/4" Ø 4 3/8" CAP. 12 3/7 oz



UTOPIA 21133717
Caneca Empilhável
St. Mug
Mug St.
Mug Emp.
△ 310 gr A 105 mm C 120 mm L 86 mm CAP. 425 ml
△ 3/9 lbs H 4 1/8" L 4 3/8" W 3 3/8" CAP. 14 3/8 oz



UTOPIA 21127763

Caneca 42cl
Mug 42 cl
Mug 42 cl
Mug 42cl
△ 259 gr A 113 mm C 129 mm L 100 mm CAP. 420 ml
△ 1/2 lbs H 4 3/8" L 5 1/8" W 3 3/8" CAP. 14 1/2 oz



UTOPIA 21127765

Chávena Chá com Pires 24cl
Tea Cup & Saucer 24cl
Taza Té con Platillo 24cl
Tasse et Sous-tasse Thé 24cl
△ 387 gr A 77 mm Ø 171 mm CAP. 239 ml
△ 3/8 lbs H 3" Ø 6 3/4" CAP. 8 1/2 oz

UTOPIA 21128452

Chávena Chá 24cl
Tea Cup 24cl
Taza Té 24cl
Tasse 24cl
△ 165 gr A 58 mm C 129 mm L 108 mm CAP. 239 ml
△ 3/8 lbs H 2 7/8" L 5 1/8" W 4 1/4" CAP. 8 1/2 oz

UTOPIA 21128453

Pires Chá 24cl
Tea Saucer 24cl
Platillo Té 24cl
Sous-tasse Thé 24cl
△ 222 gr A 19 mm Ø 171 mm
△ 1/2 lbs H 3/4" Ø 6 3/4"



UTOPIA 21128450

Chávena Café 10cl
Coffee Cup 10cl
Taza Café 10cl
Tasse Café. 10cl
△ 99 gr A 70 mm C 89 mm L 68 mm CAP. 106 ml
△ 3/9 lbs H 2 3/4" L 3 1/2" W 2 3/8" CAP. 3 4/7 oz



UTOPIA 21132763

Chávena Pequeno Almoço Empilhável
St. Breakfast Cup
Taza Desayuno St.
Tasse Petit Déjeuner Emp.
△ 269 gr A 59 mm C 134 mm L 104 mm CAP. 311 ml
△ 3/8 lbs H 2 1/8" L 5 3/8" W 4 1/8" CAP. 10 1/2 oz

UTOPIA 21127764

Chávena Café com Pires 10cl
Coffee Cup & Saucer 10cl
Taza Café con Platillo 10cl
Tasse et Sous-tasse Café. 10cl
△ 223 gr A 87 mm Ø 134 mm CAP. 106 ml
△ 1/2 lbs H 3 3/8" Ø 5 3/8" CAP. 3 4/7 oz

UTOPIA 21128451

Pires Café 10cl
Coffee Saucer 10cl
Platillo Café 10cl
Sous-tasse Café. 10cl
△ 124 gr A 17 mm Ø 134 mm
△ 3/9 lbs H 2 3/8" Ø 5 3/8"

UTOPIA 21131020

Chávena Pequeno Almoço com Pires Emp.
St. Breakfast Cup & Saucer
Taza Desayuno Platillo St.
Tasse et Sous-tasse Petit Déjeuner Emp.
△ 429 gr A 67 mm Ø 186 mm
△ 1 lbs H 2 5/8" Ø 7 1/8"

UTOPIA 21132766

Pires Chávena Pequeno Almoço Emp
St. Breakfast Saucer
Platillo Desayuno St.
Sous-tasse Petit Déjeuner Emp.
△ 267 gr A 18 mm Ø 185 mm
△ 3/8 lbs H 3/8" Ø 7 3/8"



UTOPIA 21132762

Chávena Chá Empilhável
St. Tea Cup
Taza Té St.
Tasse Thé Emp.
△ 205 gr A 56 mm C 119 mm L 90 mm CAP. 220 ml
△ 3/9 lbs H 2 1/8" L 4 3/8" W 3 3/8" CAP. 7 4/7 oz



UTOPIA 21132761

Chávena Café Empilhável
St. Coffee Cup
Taza Café St.
Tasse Café Emp.
△ 122 gr A 68 mm C 83 mm L 56 mm CAP. 94 ml
△ 3/9 lbs H 2 3/8" L 3 1/4" W 2 1/8" CAP. 3 1/8 oz

UTOPIA 21131019

Chávena Chá com Pires Emp.
St. Tea Cup & Saucer
Taza Té Platillo St.
Tasse et Sous-tasse Té Emp.
△ 548 gr A 63 mm Ø 169 mm
△ 1 1/8 lbs H 2 1/2" Ø 6 3/8"

UTOPIA 21132765

Pires Chá Empilhável
St. Tea Saucer
Platillo Té St.
Sous-tasse Thé Emp.
△ 230 gr A 18 mm Ø 169 mm
△ 1/2 lbs H 3/8" Ø 6 3/8"

UTOPIA 21131018

Chávena Café com Pires Emp.
St. Coffee Cup & Saucer
Taza Café Platillo St.
Tasse et Sous-tasse Café Emp.
△ 350 gr A 70 mm Ø 170 mm
△ 3/9 lbs H 2 3/4" Ø 6 3/8"

UTOPIA 21132764

Pires Café Empilhável
St. Coffee Saucer
Platillo Café St.
Sous-tasse Café Emp.
△ 132 gr A 17 mm Ø 134 mm
△ 3/9 lbs H 3/8" Ø 5 3/8"



UTOPIA 21134334

Chávena Consomé
Consomme Cup
Taza Consomé
Tasse Bouillon
△ 180 gr A 58 mm C 150 mm L 108 mm
△ 3/8 lbs H 2 3/8" L 6" W 4 1/4"

UTOPIA 21134335

Chávena Consomé com Pires
Consomme Cup & Saucer
Taza Consomé c/ Platillo
Tasse et Soucoupe Bouillon
△ 402 gr A 58 mm Ø 171 mm
△ 9/9 lbs H 2 3/8" Ø 6 3/4"

UTOPIA 21128453

Pires Chá 24cl
Tea Saucer 24cl
Platillo Té 24cl
Sous-tasse Thé 24cl
△ 222 gr A 19 mm Ø 171 mm
△ 1/2 lbs H 3/4" Ø 6 3/4"





A todas as peças é aplicado backstamp Casa Alegre by Vista Alegre
All pieces have backstamp Casa Alegre by Vista Alegre
Todas las piezas tienen backstamp Casa Alegre by Vista Alegre
Toutes les pièces prennent le timbre Casa Alegre by Vista Alegre à l'arrière

CONTEMPORARY





AMAZÔNIA



Parte integrante desta coleção de mais de 70 peças, a Coleção Amazônia, com peças utilitárias em grés, composta por um serviço de mesa alargado, com uma exuberância própria inspirada pela flora da maior floresta tropical do mundo. As cores das plantas e flores, as texturas e formas exóticas das suas sementes e frutos, são uma fonte de inspiração inesgotável, que encontrou a sua expressão perfeita nesta coleção.

A key part of this collection featuring more than 70 pieces, Amazônia Collection, with utilitarian pieces in stoneware comprised of an extensive selection of tableware, with a unique exuberance inspired by the flora of the world's largest tropical forest. The colors of the plants and flowers, and the exotic shapes and textures of their seeds and fruit, are an endless source of inspiration perfectly expressed by the pieces brought by Casa Alegre to this unique project.

Parte integrante de esta colección de más de 70 piezas, trae toda su personalidad a la Colección Amazônia, con piezas prácticas en gres compuestas por un servicio de mesa ampliado, con una exuberancia propia inspirada en la flora de la selva tropical más grande del mundo. Los colores de las plantas y flores, las texturas y formas exóticas de sus semillas y frutos son una fuente de inspiración inagotable, que encontró su perfecta expresión en las piezas con las que Casa Alegre contribuye para este proyecto único.

Partie intégrante de cette collection de plus de 70 pièces, la Collection Amazônia, avec des pièces utilitaires en grès composant un service de table élargi, dont l'exubérance s'inspire de la plus grande forêt tropicale du monde. Les couleurs des plantes et des fleurs, les textures et les formes exotiques des graines et des fruits, sont une source d'inspiration inépuisable qui trouve son expression parfaite dans les pièces avec lesquelles Casa Alegre contribue à ce projet unique.





AMAZÔNIA 37004632
Prato Marcador 33
Charger Plate 33
Plato Presentación 33
Assiette à Présentation 33
△ 1111 gr A 26 mm Ø 325 mm
△ 2 9/16 lbs H 1" Ø 4"



AMAZÔNIA 37004637
Prato Raso 28
Dinner Plate 28
Plato Llano 28
Assiette Plate 28
△ 770 gr A 27 mm C 280 mm L 277 mm
△ 1 3/8 lbs H 1" L 11" W 11"



AMAZÔNIA 37004642
Prato Fundo 22
Deep Plate 22
Plato Hondo 22
Assiette Creuse 22
△ 592 gr A 44 mm C 220 mm L 212 mm
△ 1 1/8 lbs H 1 3/4" L 8 2/3" W 8 1/3"



AMAZÔNIA 37004627
Prato Sobremesa 23
Dessert Plate 23
Plato Postre 23
Assiette à Dessert 23
△ 485 gr A 27 mm C 232 mm L 222 mm
△ 1 lbs H 1" L 9 1/2" W 8 3/4"



AMAZÔNIA 37004636
Prato Pasta 28
Pasta Plate 28
Plato Pasta 28
Assiette à Pâtes 28
△ 830 gr A 43 mm C 280 mm L 265 mm
△ 1 1/2 lbs H 1 1/2" L 11" W 10 3/4"



AMAZÔNIA 37004641
Prato Pão 18
Bread & Butter Plate 18
Plato Pan 18
Assiette à Pain 18
△ 346 gr A 24 mm Ø 175 mm
△ 3/4 lbs H 1" Ø 10 1/4"



AMAZÔNIA 37004630
Travessa Redonda 41
Round Platter 41
Fuente Redonda 41
Plat à Servir Rond 41
△ 2415 gr A 55 mm Ø 409 mm
△ 5 1/2 lbs H 2 1/8" Ø 16 1/8"



AMAZÔNIA 37004635
Travessa Oval 39
Oval Platter 39
Fuente Oval 39
Plat à Servir Ovale 39
△ 1580 gr A 34 mm C 286 mm L 311 mm
△ 3 1/2 lbs H 1 1/2" L 15 1/2" W 12 1/4"



AMAZÔNIA 37005068
Tabuleiro 45
Platter 45
Fuente 45
Plat à Servir 45
△ 715 gr A 17 mm C 452 mm L 131 mm
△ 1 5/8 lbs H 2/3" L 17 3/4" W 5 1/8"



AMAZÔNIA 37005069
Travessa 32
Platter 32
Fuente 32
Plat à Servir 32
△ 521 gr A 46 mm C 314 mm L 116 mm
△ 1 1/8 lbs H 1 1/2" L 12 1/2" W 4 1/2"



AMAZÔNIA 37004640

Saladeira 26
Salad Bowl 26
Ensaladera 26
Saladier 26

△ 1000 gr A 110 mm Ø 260 mm
△ 2 ½ lbs H 4 ½" Ø 10 ¼"



AMAZÔNIA 37005066

Taça 35
Bowl 35
Taza 35
Bol 35

△ 1111 gr A 120 mm C 345 mm L 330 mm
△ 2 ¾ lbs H 4 ¾" L 13 ¾" W 13"



AMAZÔNIA 37005067

Taça 24
Bowl 24
Taza 24
Bol 24

△ 950 gr A 100 mm C 240 mm L 222 mm
△ 2 lbs H 4" L 9 ¾" W 8 ¾"



AMAZÔNIA 37004626

Tigela 450 ml
Bowl 450 ml
Taza 450 ml
Bol 450 ml

△ 400 gr A 49 mm C 168 mm L 166 mm
△ ¾ lbs H 2" L 6 ¾" W 6 ½"

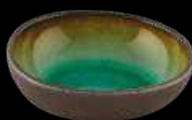

AMAZÔNIA 37004631

Taça 10 x 3,5
Bowl 10x3,5
Taza 10x3,5
Bol 10x3,5

△ 146 gr A 33 mm C 106 mm L 100 mm
△ ½ lbs H 2 ¾" L 4 ½" W 4"



AMAZÔNIA 37004639

Taça 10 x 6
Bowl 10x6
Taza 10x6
Bol 10x6

△ 191 gr A 59 mm C 100 mm L 93 mm
△ ¾ lbs H 2 ½" L 4" W 3 ½"



AMAZÔNIA 37004628

Copo 340 ml
Cup 340 ml
Vaso 340 ml
Tasse 340 ml

△ 364 gr A 106 mm Ø 89 mm
△ ¾ lbs H 4 ½" Ø 3 ½"



AMAZÔNIA 37004629

Taça 9 cl
Bowl 9 cl
Taza 9 cl
Bol 9 cl

△ 100 gr A 64 mm Ø 58 mm
△ ¾ lbs H 2 ½" Ø 2 ¾"



AMAZÔNIA 37004638

Caneca 400 ml
Mug 400 ml
Mug 400 ml
Mug 400 ml

△ 266 gr A 108 mm C 126 mm L 90 mm
△ ¾ lbs H 4 ¼" L 5" W 3 ½"





BRONZE

O tom sólido desta coleção, mais clássico e contido, é contrariado pela espontaneidade das formas do grés, impressas pelo fabrico manual. Esta imperfeição elegante comum às peças neste material, conjugadas com a singularidade da cor, fazem de *Bronze* uma proposta surpreendente.

The solid tone of this collection, more classic and restrained, is contrasted by the stoneware forms spontaneity, pressed with manual manufacture. This elegant imperfection common to the pieces made in this material, mixed with the uniqueness of the color, make Bronze an amazing proposal.

El tono sólido de esta colección, clásico y conservador, se contradice por la espontaneidad de las formas del grés, impreso mediante fabricación manual. Esta elegante imperfección común a las piezas hechas en este material, mezcladas con la singularidad del color, hacen de Bronze una propuesta sorprendente.

Le ton solide de cette collection, plus classique et contenu, est contrarié par la spontanéité des formes en grès, imprimé par la fabrication manuelle. Cette imperfection élégante commune aux pièces réalisées par ce matériau, conjugué avec le caractère unique de la couleur, fait du bronze une proposition étonnante.





BRONZE 37003620
 Travessa Oval 49
 Oval Platter 49
 Fuente Oval 49
 Plat à Servir Ovale 49
 △ 1410 gr A 36 mm C 489 mm L 236 mm
 △ 3 1/8 lbs H 1 3/4" L 19 1/4" W 9 3/8"



BRONZE 37003616
 Prato Raso 29
 Dinner Plate 29
 Plato Llano 29
 Assiette Plate 29
 △ 858 gr A 44 mm C 295 mm L 274 mm
 △ 1 9/16 lbs H 1 3/4" L 11 5/8" W 10 7/8"



BRONZE 37003617
 Prato Sobremesa 25
 Dessert Plate 25
 Plato Postre 25
 Assiette à Dessert 25
 △ 579 gr A 36 mm C 249 mm L 230 mm
 △ 1 2/7 lbs H 1 3/8" L 9 5/8" W 9"



BRONZE 37003621
 Saladeira 26
 Salad Bowl 26
 Ensaladera 26
 Saladier 26
 △ 1109 gr A 119 mm C 257 mm L 237 mm CAP. 2250 ml
 △ 2 4/8 lbs H 4 2/8" L 10 1/8" W 9 1/8" CAP. 76 1/8 oz



BRONZE 37004069
 Taça Sopa 870 ml
 Soup Bowl 870 ml
 Tazón Sopa 870 ml
 Bol de Soup 870 ml
 △ 574 gr A 74 mm ∅ 203 mm CAP. 870 ml
 △ 5/8 lbs H 2 2/8" ∅ 4 1/8" CAP. 76 1/8 oz



BRONZE 37003618
 Tigela Cereais 390 ml
 Cereal Bowl 390 ml
 Bowl Cereales 390 ml
 Bol Céréales 390 ml
 △ 378 gr A 68 mm C 155 mm L 145 mm CAP. 390 ml
 △ 5/8 lbs H 2 2/8" L 6 1/8" W 5 3/8" CAP. 13 1/8 oz



CORVAL



Misturar, verter e servir. Esta é a proposta das tigelas minimalistas Corval. Apresentando um ligeiro bico que ajuda a verter mais facilmente, estas tigelas em grés são ideais para misturar e verter massas para bolos e servir saladas e acompanhamentos num conjunto de tigelas que se encaixam umas nas outras, conferindo tons modernos à sua mesa.

Mix, pour and serve. This is the claim of Corval minimalist mixing bowls made of durable stoneware. With a subtle spout for easy pouring, the ceramic bowls are perfect for mixing and pouring batters, serving salads and sides in the nesting set to add modern hues to your table.

Mezclar, verter y servir. Esta es la afirmación de los boles minimalistas Corval. Con un sutil pico para un fácil vertido, estos boles en gres son perfectos para mezclar y verter masas, servir ensaladas y guarniciones en el juego de anidamiento para añadir matices modernos a su mesa.

Mélanger, verser et servir. C'est l'ambition des bols minimalistes Corval. Avec leur bec fin permettant de verser avec aisance, ces bols en grés sont parfaits pour mélanger et verser une pâte à gateaux, servir des salades et/ou accompagnements. Ils apporteront une touche de modernité sur votre table.





CORVAL 27021213
Tigela 27
Bowl 27
Bol 27
△1787 gr A 120 mm C 270 mm L 250 mm
△4 lbs H 4 3/4" L 10 3/8" W 9 3/8"



CORVAL 27021214
Tigela 20
Bowl 20
Bowl 20
Bol 20
△853 gr A 100 mm C 200 mm L 190 mm
△1 7/8 lbs H 4" L 7 7/8" W 7 1/8"



CORVAL 27021215
Tigela 14
Bowl 14
Bowl 14
Bol 14
△396 gr A 75 mm C 140 mm L 130 mm
△7/8 lbs H 3" L 5 1/2" W 5 1/8"



EXUBERANT

A decoração de *Exuberant* conjuga com vivacidade vidrado preto e listas brilhantes. Os seus motivos de plantas selvagens, em grande escala, pintadas à mão de um modo muito livre, remetem para paisagens intocadas pelas mãos do homem.

The Exuberant collection combines black glazed vivacity and glossy lines. Its large-scale wild plant motifs, hand-painted in a very free style, refer to landscapes untouched by the hands of man.

La decoración de Exuberant conjuga con vivacidad el vidriado negro y las líneas brillantes. Sus motivos de plantas salvajes, a gran escala, pintadas a mano de un modo muy libre, nos trasladan a paisajes intangibles por las manos del hombre.

La collection Exuberant associe une vivacité vitrée en noire avec des lignes brillantes. Ses motifs de plantes sauvages à grande échelle, peints à la main de manière très libre, se réfèrent à des paysages intacts par les mains de l'homme.





EXUBERANT 37003598

Travessa Oval 39

Oval Platter 39

Fuente Oval 39

Plat à Servir Ovale 39

△ 1580 gr A 34 mm C 386 mm L 311 mm
 △ 3 1/8 lbs H 1 1/8" L 15 1/8" W 12 1/8"



EXUBERANT 37003599

Prato Marcador 33

Charger Plate 33

Plato Presentación 33

Assiette à Présentation 33

△ 1070 gr A 25 mm Ø 325 mm
 △ 2 1/8 lbs H 1" Ø 12 7/8"



EXUBERANT 37003562

Prato Raso 29

Dinner Plate 29

Plato Llano 29

Assiette Plate 29

△ 865 gr A 27 mm C 285 mm L 278 mm
 △ 2 lbs H 1" L 11 3/8" W 11"



EXUBERANT 37003565

Prato Pasta 28

Paste Plate 28

Plato Pasta 28

Assiette à Pâtes 28

△ 830 gr A 43 mm C 275 mm L 262 mm
 △ 1 5/8 lbs H 1 3/4" L 10 5/8" W 10 1/8"



EXUBERANT 37003597

Saladeira 26

Salad Bowl 26

Ensaladera 26

Saladier 26

△ 1000 gr A 110 mm Ø 260 mm
 △ 2 3/8 lbs H 10 1/4" Ø 4 1/8"



EXUBERANT 37003563

Prato Sobremesa 23

Dessert Plate 23

Plato Postre 23

Assiette à Dessert 23

△ 471 gr A 27 mm C 230 mm L 225 mm
 △ 1 lbs H 1" L 9" W 8 7/8"



EXUBERANT 37003564

Tigela 450 ml

Bowl 450 ml

Taza 450 ml

Bol 450 ml

△ 400 gr A 49 mm C 170 mm L 164 mm CAP. 450 ml
 △ 5/8 lbs H 2 1/8" L 6 3/8" W 6 3/8" CAP. 15 3/8 oz



FLORAL SCENT

Delicados e subtis, os motivos florais de *Floral Scent* são realçados pela vivacidade dos tons. Esta linha em porcelana revela verdadeiramente o seu charme no contraste com o azul orgânico e a força serena do grés.

Delicate and subtle, the floral motifs of Floral Scent are enhanced by the liveliness of the tones. This line truly reveals its charm in contrast to the organic blue and serene stoneware.

Delicados y sutiles, los motivos florales de Floral Scent son realzados por la vivacidad de los tonos. Esta línea revela verdaderamente su encanto en contraste con el azul orgánico y la fuerza serena del grés.

Delicats et subtile, les motifs de Floral Scent sont renforcées par la vivacité des tons. Cette ligne révèle vraiment son charme en contraste avec le grés bleu et la force sereine organique.



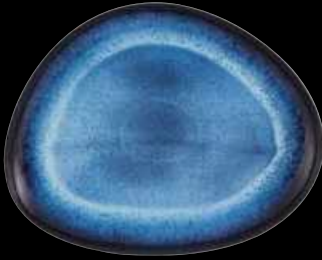

FLORAL SCENT 37003555
 Travessa Oval 39
 Oval Platter 39
 Fuente Oval 39
 Plat à Servir Ovale 39
 △ 1580 gr A 34 mm C 386 mm L 311 mm
 △ 3 1/8 lbs H 1 1/8" L 15 1/8" W 12 1/4"



FLORAL SCENT 37003548
 Prato Marcador 33
 Charger Plate 33
 Plato Presentación 33
 Assiette à Présentation 33
 △ 1070 gr A 25 mm Ø 325 mm
 △ 2 1/8 lbs H 1" Ø 12 5/8"



FLORAL SCENT 37003549
 Prato Raso 29
 Dinner Plate 29
 Plato Llano 29
 Assiette Plate 29
 △ 865 gr A 27 mm C 285 mm L 278 mm
 △ 2 lbs H 1" L 11 3/8" W 11"



FLORAL SCENT 37003552
 Prato Pasta 28
 Paste Plate 28
 Plato Pasta 28
 Assiette à Pâtes 28
 △ 830 gr A 43 mm C 275 mm L 262 mm
 △ 1 5/8 lbs H 1 3/4" L 10 5/8" W 10 1/8"



FLORAL SCENT 37003554
 Saladeira 26
 Salad Bowl 26
 Ensaladera 26
 Saladier 26
 △ 1000 gr A 110 mm Ø 260 mm
 △ 2 3/8 lbs H 10 1/4" Ø 4 1/8"

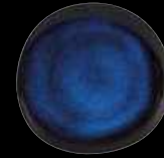

FLORAL SCENT 37003550
 Prato Sobremesa 23
 Dessert Plate 23
 Plato Postre 23
 Assiette à Dessert 23
 △ 471 gr A 27 mm C 230 mm L 225 mm
 △ 1 lbs H 1" L 9" W 8 5/8"



FLORAL SCENT 37003551
 Tigela 450 ml
 Bowl 450 ml
 Taza 450 ml
 Bol 450 ml
 △ 400 gr A 49 mm C 170 mm L 164 mm CAP. 450 ml
 △ 5/8 lbs H 2 1/8" L 6 3/8" W 6 3/8" CAP. 15 3/8 oz



FLORAL SCENT 37003553
 Caneca 400 ml
 Mug 400 ml
 Mug 400 ml
 Mug 400 ml
 △ 366 gr A 108 mm Ø 90 mm CAP. 400 ml
 △ 5/8 lbs H 4 1/4" Ø 3 1/2" CAP. 13 1/2 oz



FOOD CONCEPT

Churrasco à portuguesa ou BBQ à americana? Qualquer que seja a sua preferência, o que importa é partilhar da melhor maneira, com a coleção de grés Food Concept. Uma combinação de design e funcionalidade.

Portuguese or American BBQ – Which would you rather have? Whichever you prefer, the important thing is to share it at its best with "Food Concept" stoneware collection. A perfect combination of design and functionality to serve and share on all occasions.

¿Barbacoa portuguesa o barbacoa americana? Cualquiera que sea su preferencia, lo importante es compartir de la mejor manera, con la colección de gres «Food Concept». Una combinación perfecta de diseño y funcionalidad para servir y compartir en cualquier ocasión.

Barbecue à la portugaise ou BBQ à l'américaine ? Quel que soit votre choix, avec la collection en grès « Food Concept », le plus important c'est le partage. Une combinaison parfaite de design et de fonctionnalité, à utiliser et à partager en toute occasion.





FOOD CONCEPT 37004125
 Assadeira Kebab 41
 Kebab Roaster 41
 Fuente Horno Kebab 41
 Plat à Four 41 Kebab
 △ 2730 gr A 58 mm C 415 mm L 255 mm
 △ 6 lbs H 2 3/4" L 16 1/2" W 10"



FOOD CONCEPT 37004124
 Travessa 32
 Platter 32
 Fuente 32
 Plat à Servir 32
 △ 1305 gr A 25 mm C 320 mm L 275 mm
 △ 2 7/8 lbs H 1" L 12 3/8" W 10 5/8"



FOOD CONCEPT 37004119
 Prato Hamburguer 31
 Hamburguer Plate 31
 Plato Hamburguesa 31
 Assiette Hamburguer 31
 △ 1158 gr A 25 mm C 315 mm L 225 mm
 △ 2 5/8 lbs H 1" L 12 3/8" W 8 5/8"



FOOD CONCEPT 37004120
 Prato Espetada 31
 Skewers Plate 31
 Plato Espetada 31
 Assiette Brochette 31
 △ 1173 gr A 25 mm C 315 mm L 225 mm
 △ 2 3/8 lbs H 1" L 12 3/8" W 8 5/8"



FOOD CONCEPT 37004121
 Prato Quadrado BBQ 31
 Square Plate BBQ 31
 Plato Cuadrado 31BBQ
 Assiette Carré BBQ 31
 △ 1215 gr A 25 mm C 305 mm L 275 mm
 △ 2 7/8 lbs H 1" L 12" W 10 3/8"



FOOD CONCEPT 37004122
 Prato Salsicha 31
 Sausage Plate 31
 Plato Salchicha 31
 Plat à Saucisse 31
 △ 411 gr A 25 mm C 315 mm L 105 mm
 △ 1 lbs H 1" L 12 3/8" W 4 1/8"



FOOD CONCEPT 37004123
 Taça Molhos 12
 Sauce Bowl 12
 Taza Salsas 12
 Tasse de Sauces 12
 △ 170 gr A 35 mm C 215 mm L 95 mm
 △ 3/8 lbs H 1 3/8" L 5" W 3 3/4"



GOLD STONE

O filamento manual a ouro no bordo das peças contribui para dar à coleção *Gold Stone* um elemento extra de requinte. Este elemento decorativo acentua, por contraste, a irregularidade da forma e a organicidade do material. A combinação de técnicas e a opção pelo tom cru dão ao conjunto um perfil rústico-chique que se destaca nas tendências atuais do grés.

The manual gold filamento n the edge of each piece provide Gold Stone collection na extra refine element. This decorative element enhances, by contrast, the irregularity of the shape and the organicity of the material. The combination of techniques and the option for raw tone give the set a rustic-chic profile that stands out in the current stoneware trends.

El filamento manual a oro en el borde de las piezas proporciona a la colección Gold Stone un elemento extra de refinamiento. Este elemento decorativo acentua, por contraste, la irregularidad de la forma y la organicidad del material. La combinación de técnicas y la opción por el tono crudo, dan al conjunto un perfil rústico-chic que se destaca en las tendencias actuales del grès.

Le filament d'or manuel sur le bord de chaque pièce fournit à la collection Gold Stone un élément supplémentaire de raffinement. Cet élément décoratif accentue par contraste, l'irrégularité de la forme et l'organicité du matériau. La combinaison des techniques et l'option pour le ton cru donnent à l'ensemble un profil rustique chic qui se distingue dans les tendances courantes en grès.





GOLD STONE 37004096
 Travessa Redonda 41 Bronze
 Round Platter 41 Bronze
 Fuente Redonda 41 Bronze
 Plat à Servir Rond 41 Bronze
 △2415 gr A 55 mm Ø409 mm CAP. 2650 ml
 △5 1/8 lbs H 2 1/8" Ø16" CAP. 89 3/8 oz



GOLD STONE 37004095
 Travessa Oval 41 Bronze
 Oval Platter 41 Bronze
 Fuente Oval 41 Bronze
 Plat à Servir Ovale 41 Bronze
 △1358 gr A 26 mm C 261 mm L 406 mm
 △3 lbs H 1" L 10 3/4" W 16"



GOLD STONE 37004083
 Prato Marcador 33 Bronze
 Charger Plate 33 Bronze
 Plato Presentación 33 Bronze
 Assiette à Présentation 33 Bronze
 △1111 gr A 26 mm Ø325 mm
 △2 1/2 lbs H 1" Ø12 1/2"



GOLD STONE 37004663
 Prato Raso 27,5 Bronze
 Dinner Plate 27,5 Bronze
 Plato Llano 27,5 Bronze
 Assiette Plate 27,5 Bronze
 △835 gr A 26 mm Ø275 mm
 △1 5/8 lbs H 1" Ø10 5/8"



GOLD STONE 37004664
 Prato Sopa 23 Bronze
 Soup Plate 23 Bronze
 Plato Hondo 23 Bronze
 Assiette Creuse 23 Bronze
 △698 gr A 47 mm Ø232 mm
 △1 1/2 lbs H 1 3/4" Ø9 1/2"



GOLD STONE 37004665
 Prato Sobremesa 22 Bronze
 Dessert Plate 22 Bronze
 Plato Postre 22 Bronze
 Assiette à Dessert 22 Bronze
 △544 gr A 25 mm Ø218 mm
 △1 1/8 lbs H 1" Ø8 5/8"



GOLD STONE 37004084
 Prato Raso 29 Bronze
 Dinner Plate 29 Bronze
 Plato Llano 29 Bronze
 Assiette Plate 29 Bronze
 △851 gr A 30 mm Ø288 mm CAP. 450 ml
 △1 7/8 lbs H 1 1/8" Ø11 1/2" CAP. 17 oz



GOLD STONE 37004086
 Prato Sopa 25 Bronze
 Soup Plate 25 Bronze
 Plato Hondo 25 Bronze
 Assiette Creuse 25 Bronze
 △646 gr A 45 mm Ø254 mm
 △1 1/2 lbs H 1 1/8" Ø11 1/4"



GOLD STONE 37004085
 Prato Sobremesa 23 Bronze
 Dessert Plate 23 Bronze
 Plato Postre 23 Bronze
 Assiette à Dessert 23 Bronze
 △512 gr A 22 mm Ø231 mm
 △1 1/8 lbs H 3/4" Ø9"



GOLD STONE 37004087
 Prato Pão 18 Bronze
 Bread & Butter Plate 18 Bronze
 Plato Pan 18 Bronze
 Assiette à Pain 18 Bronze
 △346 gr A 24 mm Ø175 mm
 △3/4 lbs H 1" Ø6 5/8"



GOLD STONE 37004094
 Saladeira 26 Bronze
 Salad Bowl 26 Bronze
 Ensaladera 26 Bronze
 Saladier 26 Bronze
 △1175 gr A 110 mm Ø265 mm
 △2 3/8 lbs H 4 1/8" Ø10 3/4"



GOLD STONE 37004078
 Saladeira 26 Branco
 Salad Bowl 26 White
 Ensaladera 26 Blanco
 Saladier 26 Blanc
 △1000 gr A 110 mm Ø260 mm
 △2 3/8 lbs H 4 1/8" Ø10 1/4"



GOLD STONE 37004088
 Prato Pasta 25 Bronze
Paste Plate 25 Bronze
Plato Pasta 28 Bronze
Assiette à Pâtes 25 Bronze
 △ 722 gr A 62 mm Ø 254 mm
 △ 1 3/8 lbs H 2 1/2" Ø 10"



GOLD STONE 37004076
 Prato Pasta 22 Branco
Paste Plate 22 White
Plato Pasta 22 Blanco
Assiette à Pâtes 22 Blanc
 △ 592 gr A 43 mm C 220 mm L 212 mm
 △ 1 1/8 lbs H 1 7/8" L 11" W 10 3/4"



GOLD STONE 37004077
 Tigela 450 ml Branco
Bowl 450 ml White
Taza 450 ml Blanco
Bol 450 ml Blanc
 △ 400 gr A 49 mm C 168 mm
 L 166 mm CAP. 450 ml
 △ 7/8 lbs H 2" L 6 3/8"
 W 6 1/2" CAP. 15 7/8 oz



GOLD STONE 37004089
 Tigela Cereais 560 ml Bronze
Cereal Bowl 560 ml Bronze
Tazón Cereales 560 ml Bronze
Bol Céréales 560 ml Bronze
 △ 341 gr A 75 mm Ø 160 mm CAP. 560 ml
 △ 3/4 lbs H 6 3/8" Ø 6 3/4" CAP. 19 oz



GOLD STONE 37004092
 Taça Individual 11 Bronze
Individual Bowl 11 Bronze
Taza Individual 11 Bronze
Bol Individuel 11 Bronze
 △ 176 gr A 52 mm Ø 119 mm
 △ 3/8 lbs H 2" Ø 4 3/8"



GOLD STONE 37004079
 Taça Individual 10 Branco
Individual Bowl 10 White
Taza Individual 10 Blanco
Bol Individuel 10 Blanc
 146 gr A 33 mm C 106 mm
 L 100 mm CAP. 70 ml
 △ 3/8 lbs H 1 3/8" L 6 3/8"
 W 1/2" CAP. 2 3/8 oz



GOLD STONE 37004093
 Taça 9cl Bronze
Bowl 9cl Bronze
Mug 9cl Bronze
Bol 9cl Bronze
 △ 100 gr A 64 mm Ø 58 mm CAP. 90 ml
 △ 3/8 lbs H 2 1/2" Ø 2 3/4" CAP. 3 oz



GOLD STONE 37004082
 Taça 9cl Branco
Bowl 9cl White
Mug 9cl Blanco
Bol 9cl Blanc
 △ 100 gr A 64 mm Ø 58 mm CAP. 90 ml
 △ 3/8 lbs H 2 1/2" Ø 2 3/4" CAP. 3 oz



GOLD STONE 37004090
 Caneca 340 ml Bronze
Mug 340 ml Bronze
Mug 340 ml Bronze
Mug 340 ml Bronze
 △ 384 gr A 108 mm Ø 131 mm CAP. 340 ml
 △ 9/8 lbs H 4 1/4" Ø 5 1/8" CAP. 11 1/2 oz



GOLD STONE 37004091
 Copo 340 ml Bronze
Glass 340 ml Bronze
Vaso 340 ml Bronze
Gobelet 340 ml Bronze
 △ 364 gr A 106 mm Ø 89 mm CAP. 340 ml
 △ 8/8 lbs H 4 1/8" Ø 3 1/2" CAP. 11 1/2 oz





IMPERFECT WHITE

A coleção Imperfect White incorpora um tom neutro, através de um vidrado natural, combinado com formas simples, mas acentuadas. Uma gama em grés, informal, mas eclética, de pratos, tigelas, caneca e travessa que acrescentam um toque artesanal a qualquer mesa.

Imperfect White collection embodies a neutral tone through a natural glaze combined with simple but strong forms. An informal yet eclectic stoneware assortment of plates, bowls, mug and platter that will add a hand-crafted look to each table.

La colección Imperfect White incorpora un tono neutro a través de un vidriado natural combinado con formas simples pero acentuadas. Una colección de gres, informal pero ecléctica, de platos, boles, taza y bandeja que añadirá un aspecto artesanal a cada mesa.

La collection Imperfect White révèle des tons neutres obtenus par glaçure naturelle, associés à des formes simples et puissantes. Une gamme en grès, informelle mais éclectique, d'assiettes, de bols, de mugs et de plats qui donnent un aspect artisanal à n'importe quelle table.





IMPERFECT WHITE 37004715
Prato Marcador 33
Charger Plate 33
Plato Presentación 33
Assiette à Présentation 33
△ 1245 gr A 22 mm Ø 329 mm
△ 2 ¾ lbs H ¾" Ø 13"



IMPERFECT WHITE 37004727
Prato Raso 27
Dinner Plate 27
Plato Llano 27
Assiette Plate 27
△ 646 gr A 27 mm Ø 265 mm
△ 2 ¾ lbs H 1" Ø 10 ½"



IMPERFECT WHITE 37005056
Prato Fundo 22
Deep Plate 22
Plato Hondo 22
Assiette Creuse 22
△ 505 gr A 41 mm Ø 220 mm
△ 1 ½ lbs H 1 ¾" Ø 8 ¾"



IMPERFECT WHITE 37004728
Prato Sobremesa 22
Dessert Plate 22
Plato Postre 22
Assiette à Dessert 22
△ 422 gr A 22 mm Ø 225 mm
△ 1 lbs H ¾" Ø 8 ¾"



IMPERFECT WHITE 37004730
Caneca
Mug
Mug
Mug
△ 370 gr A 120 mm C 140 mm L 95 mm
△ ¾ lbs H 4 ½" L 5 ½" W 3 ¾"



IMPERFECT WHITE 37004729
Saladeira 25
Salad Bowl 25
Ensaladera 25
Saladier 25
△ 1101 gr A 103 mm C 253 mm L 247 mm
△ 2 ¾ lbs H 4" L 10" W 9 ½"



IMPERFECT WHITE 37004731
Tigela 16
Bowl 16
Taza 16
Bol 16
△ 400 gr A 77 mm Ø 160 mm
△ ¾ lbs H 3" Ø 6 ¾"



IMPERFECT WHITE 37004726
Travessa Oval 40
Oval Tray 40
Fuente Oval 40
Plat à Servir Oval 40
△ 1582 gr A 41 mm C 400 mm L 280 mm
△ 3 ½ lbs H 1 ¾" L 15 ¾" W 11"



IRIS

O contraste dos efeitos nesta coleção em grés, criado com os tons, o brilho e a textura, brinca com a perceção e cativa pela originalidade, conferindo simultaneamente um inesperado requinte a cada peça.

The contrast of the effects in this stoneware collection, generated by the tones, the brightness and the texture, plays with the perception and wins by the originality, providing simultaneously an unexpected refinement to each piece.

El contraste de los efectos en esta colección de gres, creada con los tonos, el brillo y la textura, juega con la percepción y cautiva gracias a su originalidad, dando al mismo tiempo un inesperado refinamiento a cada pieza.

Le contraste des effets de cette collection de grès crée par les tons, la luminosité et la texture, joue avec la perception et gagne par l'originalité, offrant simultanément un raffinement inattendu à chaque pièce.





IRIS 37003749
Travessa Redonda 41
Round Plate 41
Fuente Redonda 41
Plat à Servir Rond 41
△ 2415 gr A 55 mm Ø 409 mm CAP. 2650 ml
△ 5 1/2 lbs H 2 1/8" Ø 16" CAP. 89 3/8 oz



IRIS 37003748
Travessa Oval 41
Oval Platter 41
Fuente Oval 41
Plat à Servir Ovale 41
△ 1358 gr A 26 mm C 261 mm L 406 mm
△ 3 lbs H 1" L 16" W 10 3/4"



IRIS 37003736
Prato Marcador 33
Charger Plate 33
Plato Presentación 33
Assiette à Présentation 33
△ 1111 gr A 26 mm Ø 325 mm
△ 2 3/8 lbs H 1" Ø 12 1/8"



IRIS 37004594
Prato Raso 27,5
Dinner Plate 27,5
Plato Llano 27,5
Assiette Plate 27,5
△ 835 gr A 26 mm Ø 275 mm
△ 1 5/8 lbs H 1" Ø 10 5/8"



IRIS 37004656
Prato Sobremesa 22
Dessert Plate 22
Plato Postre 22
Assiette à Dessert 22
△ 544 gr A 25 mm Ø 218 mm
△ 1 1/8 lbs H 1" Ø 8 5/8"

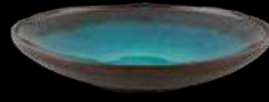

IRIS 37004595
Prato Sopa 23
Soup Plate 23
Plato Hondo 23
Assiette Creuse 23
△ 698 gr A 47 mm Ø 232 mm
△ 1 1/2 lbs H 1 5/8" Ø 9 1/8"



IRIS 37003740
Prato Pão 18
Bread & Butter Plate 18
Plato Pan 18
Assiette à Pain 18
△ 346 gr A 24 mm Ø 175 mm
△ 3/4 lbs H 1" Ø 6 8/8"



IRIS 37003739
Prato Sopa 25
Soup Plate 25
Plato Hondo 25
Assiette Creuse 25
△ 646 gr A 45 mm Ø 254 mm
△ 1 7/8 lbs H 1 1/8" Ø 11 1/8"



IRIS 37003741
Prato Pasta 25
Pasta Plate 25
Plato Pasta 25
Assiette à Pâtes 25
△ 722 gr A 62 mm Ø 254 mm
△ 2 lbs H 2 1/2" Ø 10"



IRIS 37003742
Tigela Cereais 625 ml
Cereal Bowl 625 ml
Tazón Cereales 625 ml
Bol Céréales 625 ml
△ 448 gr A 68 mm C 162 mm CAP. 625 ml
△ 1 lbs H 2 3/8" Ø 6 1/8" CAP. 21 1/2 oz



IRIS 37003743
Tigela Cereais 560 ml
Cereal Bowl 560 ml
Tazón Cereales 560 ml
Bol Céréales 560 ml
△ 341 gr A 75 mm Ø 160 mm CAP. 560 ml
△ 3/4 lbs H 6 8/8" Ø 6 3/8" CAP. 19 oz



IRIS 37003746
Taça Individual 11
Individual Bowl 11
Taza Individual 11
Bol Individuel 11
△ 176 gr A 52 mm Ø 119 mm CAP. 255 ml
△ 1 lbs H 2" Ø 6 1/8" CAP. 8 5/8 oz



IRIS 37003747
Saladeira 26
Salad Bowl 26
Ensaladera 26
Saladier 26
△ 1175 gr A 110 mm Ø 265 mm
△ 2 3/8 lbs H 4 1/4" Ø 10 3/8"



IRIS 37003744
Caneca 340 ml
Mug 340 ml
Mug 340 ml
Mug 340 ml
△ 384 gr A 108 mm C 131 mm L 91 mm CAP. 340 ml
△ 5/8 lbs H 4 1/4" L 5 1/8" W 3 3/8" CAP. 11 1/2 oz



IRIS 37003745
Copo 340 ml
Glass 340 ml
Vaso 340 ml
Tasse 340 ml
△ 364 gr A 106 mm Ø 89 mm CAP. 340 ml
△ 1/2 lbs H 4 1/8" Ø 3 1/2" CAP. 11 1/2 oz



LAGOON



Os ecossistemas da Terra são agredidos incessantemente pela ação humana. Grande parte dos cenários grandiosos de outrora estão a desaparecer ou a mudar a sua configuração para algo imprevisível. A coleção em grés Lagoon cristaliza a beleza dos glaciares e dos ambientes aquáticos, dois cenários onde mais se fazem sentir as alterações climáticas, retratando, em paralelo, esse processo de transformação – lembrando-nos que temos todos de agir antes que seja demasiado tarde.

The Earth's ecosystems are constantly being attacked by human action. Most of the magnificent scenery of the past is disappearing or changing its configuration to something that is unpredictable. Lagoon stoneware collection embodies the beauty of glaciers and aquatic environments – two settings where climate change is most pronounced. At the same time, the collection depicts this transformation process, reminding

Los ecosistemas terrestres son atacados constantemente por la acción humana. La mayoría de los grandiosos escenarios del pasado están desapareciendo o cambiando su configuración para algo impredecible. La colección Lagoon en grés cristaliza la belleza de los glaciares y los ambientes acuáticos, dos escenarios en donde más se siente el cambio climático, que retratan, paralelamente, este proceso de transformación, recordándonos que todos debemos actuar antes de que sea demasiado tarde.

Les écosystèmes sont constamment agressés par l'action humaine. Une grande partie des paysages grandioses d'autrefois sont en train de disparaître ou de changer de manière imprévisible. La collection en grés Lagoon cristallise la beauté des glaciers et des milieux aquatiques, deux environnements où les changements climatiques se font le plus sentir. Elle dépeint, en parallèle, ce processus de transformation, et nous rappelle que nous devons tous agir avant qu'il ne soit trop tard.





LAGOON 37004608
Travessa Redonda
Round Platter 41
Fuente Redonda 41
Plat à Servir Rond 41
△ 2657 gr A 55 mm Ø 409 mm
△ 5 7/8 lbs H 2 1/8" Ø 16 1/8"



LAGOON 37004606
Prato Marcador 33
Charger Plate 33
Plato Presentación 33
Assiette à Présentation 33
△ 1222 gr A 26 mm Ø 325 mm
△ 2 3/8 lbs H 1" Ø 12 7/8"



LAGOON 37004612
Prato Raso 27,5
Dinner Plate 27,5
Plato Llano 27,5
Assiette Plate 27,5
△ 919 gr A 26 mm Ø 275 mm
△ 2 lbs H 1" Ø 10 7/8"



LAGOON 37004613
Prato Fundo 23
Soup Plate 23
Plato Hondo 23
Assiette Creuse 23
△ 768 gr A 47 mm Ø 232 mm
△ 1 7/8 lbs H 1 9/16" Ø 9 1/8"



LAGOON 37004614
Prato Sobremesa 22
Dessert Plate 22
Plato Postre 22
Assiette à Dessert 22
△ 598 gr A 25 mm Ø 218 mm
△ 1 1/8 lbs H 1" Ø 8 5/8"



LAGOON 37004607
Prato Pão 18
Bread & Butter Plate 18
Plato Pan 18
Assiette à Pain 18
△ 577 gr A 24 mm Ø 175 mm
△ 2 3/8 lbs H 1" Ø 6 7/8"



LAGOON 37004618
Saladeira 26
Salad Bowl 26
Ensaladera 26
Saladier 26
△ 1293 gr A 110 mm Ø 265 mm
△ 2 7/8 lbs H 4 1/8" Ø 10 3/8"



LAGOON 37004615
Taça Cereal 560 ml
Cereal Bowl 560 ml
Tazón Cereales 560 ml
Bol Céréales 560 ml
△ 375 gr A 75 mm Ø 160 mm
△ 3/8 lbs H 3" Ø 6 3/8"



LAGOON 37004616
Taça individual 11
Individual Bowl 11
Taza Individual 11
Bol Individuel 11
△ 194 gr A 52 mm Ø 119 mm
△ 3/8 lbs H 2" Ø 4 3/8"



LAGOON 37004609
Travessa Oval 41
Oval Platter 41
Fuente Oval 41
Plat à Servir Oval 41
△ 1494 gr A 31 mm C 405 mm L 261 mm
△ 3 3/8 lbs H 1 3/8" L 16 W 10 3/8"



NOIR

Os tons negros dominam nesta coleção sóbria. A combinação do preto mate com o vidrado em azul lazúli reproduz um ambiente dramático e permite acentuar todos os emplatamentos.

Black tones prevail in this sober collection. The combination of matte black and lazuli blue glaze recreate a dramatic environment and emphasize the gourmet presentation.

Los tonos negros dominan en esta sobria colección. La combinación del negro mate con el vidriado en azul lazúli reproduce un ambiente dramático y permite acentuar todos los emplatados.

Les tons noirs dominent dans cette collection sobre. La combinaison de noir mat et de laque bleue Lazuli recrée un environnement dramatique permettant de souligner la présentation gastronomique.



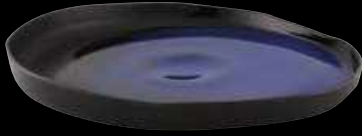

NOIR 37003689
Travessa Redonda 41
Round Platter 41
Fuente Redonda 41
Plat à Servir Rond 41
△ 2415 gr A 55 mm Ø 409 mm CAP. 2650 ml
△ 5 1/2 lbs H 2 1/4" Ø 16" CAP. 89 3/4 oz



NOIR 37003678
Travessa Oval 41
Oval Platter 41
Fuente Oval 41
Plat à Servir Ovale 41
△ 1358 gr A 26 mm C 261 mm L 406 mm
△ 3 lbs H 1" L 16" W 10 3/4"



NOIR 37003680
Prato Marcador 33
Charger Plate 33
Plato Presentación 33
Assiette à Présentation 33
△ 1111 gr A 26 mm Ø 325 mm
△ 2 3/8 lbs H 1" Ø 12 1/2"



NOIR 37004660
Prato Raso 27,5
Dinner Plate 27,5
Plato Llano 27,5
Assiette Plate 27,5
△ 835 gr A 26 mm Ø 275 mm
△ 1 3/8 lbs H 1" Ø 10 5/8"



NOIR 37003671
Prato Pasta 25
Pasta Plate 25
Plato Pasta 25
Assiette à Pâtes 25
△ 722 gr A 62 mm Ø 254 mm
△ 2 lbs H 2 1/2" Ø 10"



NOIR 37004662
Prato Sobremesa 22
Dessert Plate 22
Plato Postre 22
Assiette à Dessert 22
△ 544 gr A 25 mm Ø 218 mm
△ 1 1/8 lbs H 1" Ø 8 5/8"



NOIR 37004661
Prato Sopa 23
Soup Plate 23
Plato Hondo 23
Assiette Creuse 23
△ 698 gr A 47 mm Ø 232 mm
△ 1 1/2 lbs H 1 3/4" Ø 9 1/8"



NOIR 37003683
Prato Sopa 25
Soup Plate 25
Plato Hondo 25
Assiette Creuse 25
△ 646 gr A 45 mm Ø 254 mm
△ 1 3/8 lbs H 1 1/8" Ø 11 1/8"



NOIR 37003684
Prato Pão 18
Bread & Butter Plate 18
Plato Pan 18
Assiette à Pain 18
△ 346 gr A 24 mm Ø 175 mm
△ 3/4 lbs H 1" Ø 6 3/8"



NOIR 37003672
Tigela Cereais 625 ml
Cereal Bowl 625 ml
Tazón Cereales 625 ml
Bol Céréales 625 ml
△ 448 gr A 68 mm C 162 mm CAP. 625 ml
△ 1 lbs H 2 3/4" Ø 6 1/2" CAP. 21 1/2 oz



NOIR 37003685
Tigela Cereais 560 ml
Cereal Bowl 560 ml
Tazón Cereales 560 ml
Bol Céréales 560 ml
△ 341 gr A 75 mm C 160 mm CAP. 560 ml
△ 3/4 lbs H 6 3/8" Ø 6 3/4" CAP. 19 oz



NOIR 37003687
Taça Individual 11
Individual Bowl 11
Taza Individual 11
Bol Individuel 11
△ 176 gr A 52 mm C 119 mm CAP. 185 ml
△ 3/8 lbs H 2" Ø 4 3/8" CAP. 6 1/4 oz



NOIR 37003688
Saladeira 26
Salad Bowl 26
Ensaladera 26
Saladier 26
△ 1175 gr A 110 mm C 265 mm
△ 2 3/8 lbs H 4 1/2" Ø 10 3/8"



NOIR 37003674
Caneca 340 ml
Mug 340 ml
Mug 340 ml
Mug 340 ml
△ 384 gr A 108 mm C 131 mm L 91 mm CAP. 340 ml
△ 3/4 lbs H 4 1/4" L 5 1/8" W 3 3/4" CAP. 11 1/2 oz



NOIR 37003686
Copo 340 ml
Glass 340 ml
Vaso 340 ml
Tasse 340 ml
△ 364 gr A 106 mm C 89 mm CAP. 340 ml
△ 1/2 lbs H 4 1/8" Ø 3 1/2" CAP. 11 1/2 oz



RUSTIC BLEND

A coleção Rustic Blend inspira-se num estilo artesanal, simples e rústico. Apresentando deslumbrantes vidrados neutros conjugados com formas simples, esta coleção de grés oferece uma combinação única de valor, resistência e estética.

Rustic Blend is inspired by artisan, handcrafting and simple country style. With stunning neutral glazes married to simple shapes, this stoneware collection offers an unrivaled combination of value, resistance and good looks.

La colección Rustic Blend se inspira en la artesanía y en el estilo rústico sencillo. Con deslumbrantes vidriados neutros unidos a formas sencillas, esta colección de gres ofrece una incomparable combinación de valor, resistencia y estética.

Rustic Blend s'inspire du style artisanal, simple et champêtre. Avec ses superbes glaçures neutres combinées à des formes simples, cette collection en grès présente une association unique de valeur, de résistance et d'esthétisme.



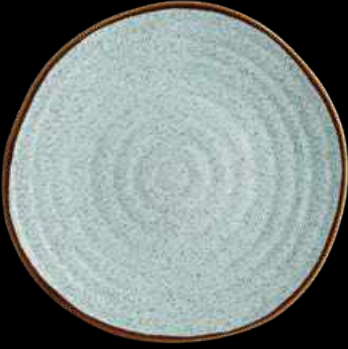

RUSTIC BLEND 27021121
Prato Raso 28 RB Turq
Dinner Plate 28 Turq
Plato Llano 28 Turq
Assiette Plate 28 Turq
△ 900 gr A 25 mm Ø 280 mm
△ 2lbs H 1" Ø 11"



RUSTIC BLEND 27020963
Prato Raso 28 RB WH
Dinner Plate 28 WH
Plato Llano 28 WH
Assiette Plate 28 WH
△ 900 gr A 25 mm Ø 280 mm
△ 2lbs H 1" Ø 11"



RUSTIC BLEND 27021122
Prato de Sobremesa 22 RB Turq
Dessert Plate 22 Turq
Plato Postre 22 Turq
Assiette à Dessert 22 Turq
△ 560 gr A 25 mm Ø 220 mm
△ 1 ¼ lbs H 1" Ø 8 ¾"



RUSTIC BLEND 27020964
Prato de Sobremesa 22 RB WH
Dessert Plate 22 WH
Plato Postre 22 WH
Assiette à Dessert 22 WH
△ 560 gr A 25 mm Ø 220 mm
△ 1 ¼ lbs H 1" Ø 8 ¾"



RUSTIC BLEND 27020973
Prato Sopa 22 RB Turq
Soup Plate 22 Turq
Plato Sopa 22 Turq
Assiette à Soupe 22 Turq
△ 780 gr A 50 mm Ø 220 mm
△ 1 ¾ lbs H 2" Ø 8 ¾"



RUSTIC BLEND 27020965
Prato Sopa 22 RB WH
Soup Plate 22 WH
Plato Sopa 22 WH
Assiette à Soupe 22 WH
△ 780 gr A 50 mm Ø 220 mm
△ 1 ¾ lbs H 2" Ø 8 ¾"



RUSTIC BLEND 27020972
Prato Fundo 28 RB Turq
Deep Plate 28 Turq
Plato Hondo 28 Turq
Assiette Creuse 28 Turq
△ 1060 gr A 40 mm Ø 280 mm
△ 2 ½ lbs H 1 ¼" Ø 11"



RUSTIC BLEND 27020961
Prato Fundo 23 RB WH
Deep Plate 23 WH
Plato Hondo 23 WH
Assiette Creuse 23 WH
△ 720 gr A 40 mm Ø 230 mm
△ 1 ¾ lbs H 1 ¼" Ø 9"



RUSTIC BLEND 27020971
Prato Fundo 23 RB Turq
Deep Plate 23 Turq
Plato Hondo 23 Turq
Assiette Creuse 23 Turq
△ 720 gr A 40 mm Ø 230 mm
△ 1 ¾ lbs H 1 ¼" Ø 9"



RUSTIC BLEND 27020962
Prato Fundo 28 RB WH
Deep Plate 28 WH
Plato Hondo 28 WH
Assiette Creuse 28 WH
△ 1060 gr A 40 mm Ø 280 mm
△ 2 ½ lbs H 1 ¼" Ø 11"



RUSTIC BLEND 27020967
 Taça 16 RB WH
 Bowl 16 WH
 Bowl 16 WH
 Bol 16 WH
 △ 420 gr A 45 mm Ø 160 mm
 △ 1 lbs H 1 7/8" Ø 6 3/8"



RUSTIC BLEND 27020975
 Taça 16 RB Turq
 Bowl 16 Turq
 Bowl 16 Turq
 Bol 16 Turq
 △ 420 gr A 45 mm Ø 160 mm



RUSTIC BLEND 27020974
 Travessa Oval 34,5 RB Turq
 Oval Tray 34,5 Turq
 Fuente Oval 34,5 Turq
 Plat à Servir Ovale 34,5 Turq
 △ 970 gr A 45 mm C 345 mm L 170 mm
 △ 2 1/2 lbs H 1 7/8" L 13 3/8" W 6 3/8"



RUSTIC BLEND 27020958
 Travessa Oval 27 RB WH
 Oval Tray 27 WH
 Fuente Oval 27 WH
 Plat à Servir Ovale 27 WH
 △ 800 gr A 45 mm C 270 mm L 200 mm
 △ 1 3/4 lbs H 1 7/8" L 10 5/8" W 7 7/8"



RUSTIC BLEND 27020968
 Travessa Oval 27 RB Turq
 Oval Tray 27 Turq
 Fuente Oval 27 Turq
 Plat à Servir Ovale 27 Turq
 △ 800 gr A 45 mm C 270 mm L 200 mm
 △ 1 3/4 lbs H 1 7/8" L 10 5/8" W 7 7/8"



RUSTIC BLEND 27020966
 Travessa Oval 34,5 RB WH
 Oval Tray 34,5 WH
 Fuente Oval 34,5 WH
 Plat à Servir Ovale 34,5 WH
 △ 970 gr A 45 mm C 345 mm L 170 mm
 △ 2 1/2 lbs H 1 7/8" L 13 3/8" W 6 3/8"



RUSTIC BLEND 27020960
 Travessa Oval 29,5 RB WH
 Oval Tray 29,5 WH
 Fuente Oval 29,5 WH
 Plat à Servir Ovale 29,5 WH
 △ 900 gr A 30 mm C 295 mm L 145 mm
 △ 2 lbs H 1 1/6" L 11 3/8" W 5 3/8"

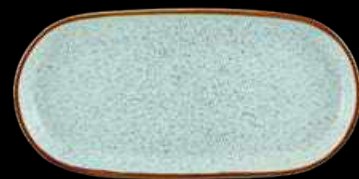

RUSTIC BLEND 27020970
 Travessa Oval 29,5 RB Turq
 Oval Tray 29,5 Turq
 Fuente Oval 29,5 Turq
 Plat à Servir Ovale 29,5 Turq
 △ 900 gr A 30 mm C 295 mm L 145 mm
 △ 2 lbs H 1 1/6" L 11 3/8" W 5 3/8"



RUSTIC BLEND 27020959
 Travessa Rectangular 36,5 RB WH
 Rectangular Tray 36,5 WH
 Fuente Rectangular 36,5 WH
 Plat à Servir Rectangulaire 36,5 WH
 △ 1100 gr A 30 mm C 365 mm L 170 mm
 △ 2 3/4 lbs H 1 1/6" L 14 3/8" W 6 3/8"



RUSTIC BLEND 27020969
 Travessa Rectangular 36,5 RB Turq
 Rectangular Tray 36,5 Turq
 Fuente Rectangular 36,5 Turq
 Plat à Servir Rectangulaire 36,5 Turq
 △ 1100 gr A 30 mm C 365 mm L 170 mm
 △ 2 3/4 lbs H 1 1/6" L 14 3/8" W 6 3/8"





SAUVAGE

Em Sauvage, cada peça transmite a sensação de texturas e formas do mundo orgânico. Tal como na natureza, os diversos elementos articulam-se de forma aparentemente aleatória, mas criando sempre uma bela harmonia.

In the Sauvage collection, each piece conveys the feeling of textures and organic world shapes. Like in nature, the various elements articulate themselves in an apparently random manner, but always in a beautiful harmony.

En Sauvage, cada pieza transmite una sensación de texturas y formas provenientes del mundo orgánico. Como en la naturaleza, los diversos elementos se articulan de forma aparentemente aleatoria, pero siempre creando una bonita armonía.

Dans la collection Sauvage, chaque pièce révèle la sensation de textures et de formes organiques du monde. Comme dans la nature, les différents éléments s'articulent de manière apparemment aléatoire, mais toujours dans une belle harmonie.





SAUVAGE 37003612
 Travessa Redonda 41
 Round Platter 41
 Fuente Redonda 41
 Plat à Servir Rond 41
 △ 2415 gr A 55 mm Ø 409 mm CAP. 2650 ml
 △ 5 1/3 lbs H 2 1/4" Ø 16" CAP. 89 3/8 oz



SAUVAGE 37003608
 Travessa Oval 39
 Oval Platter 39
 Fuente Oval 39
 Plat à Servir Ovale 39
 △ 1580 gr A 34 mm C 386 mm L 311 mm
 △ 3 1/3 lbs H 1 1/2" L 15 1/2" W 12 1/4"

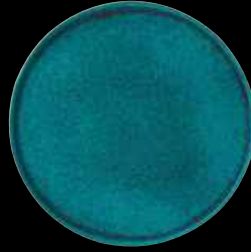

SAUVAGE 37003609
 Prato Marcador 33
 Charger Plate 33
 Plato Presentación 33
 Assiette à Présentation 33
 △ 1111 gr A 25 mm Ø 325 mm
 △ 2 1/3 lbs H 1" Ø 12 3/8"

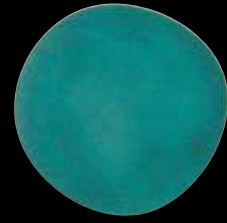

SAUVAGE 37003592
 Prato Raso 29
 Dinner Plate 29
 Plato Llano 29
 Assiette Plate 29
 △ 865 gr A 27 mm C 287 mm L 278 mm
 △ 1 7/8 lbs H 1" L 11 3/8" W 11"



SAUVAGE 37003595
 Prato Pasta 28
 Paste Plate 28
 Plato Pasta 28
 Assiette à Pâtes 28
 △ 830 gr A 43 mm C 275 mm L 262 mm
 △ 1 5/8 lbs H 1 3/4" L 10 5/8" W 10 1/2"



SAUVAGE 37003607
 Saladeira 26
 Salad Bowl 26
 Ensaladera 26
 Saladier 26
 △ 1000 gr A 110 mm Ø 260 mm
 △ 2 3/8 lbs H 10 1/4" Ø 4 1/2"



SAUVAGE 37003593
 Prato Sobremesa 23
 Dessert Platter 23
 Plato Postre 23
 Assiette à Dessert 23
 △ 471 gr A 27 mm C 232 mm L 225 mm
 △ 1 lbs H 1" L 9" W 8 5/8"



SAUVAGE 37003610
 Prato Pão 18
 Bread & Butter Plate 18
 Plato Pan 18
 Assiette à Pain 18
 △ 346 gr A 24 mm C 175 mm L 175 mm
 △ 3/4 lbs H 1" Ø 6 5/8"



SAUVAGE 37003594
 Tigela 450 ml
 Bowl 450 ml
 Taza 450 ml
 Bol 450 ml
 △ 400 gr A 49 mm C 170 mm L 164 mm CAP. 450 ml
 △ 8/8 lbs H 2 1/8" L 6 3/4" W 6 1/8" CAP. 15 3/8 oz



SAUVAGE 37003606
 Caneca 400 ml
 Mug 400 ml
 Mug 400 ml
 Mug 400 ml
 △ 366 gr A 108 mm Ø 90 mm CAP. 400 ml
 △ 4/5 lbs H 4 1/4" Ø 3 1/2" CAP. 13 1/2 oz



SAUVAGE 37003611
 Copo 340 ml
 Glass 340 ml
 Vaso 340 ml
 Gobelet 340 ml
 △ 364 gr A 106 mm Ø 89 mm CAP. 340 ml
 △ 1/2 lbs H 4 1/8" Ø 3 1/2" CAP. 11 1/2 oz



SHINE

Shine associa de modo vibrante a elegância do brilho dos metais a peças em grés com linguagem craft. Um contraste que cria uma atmosfera tão rústica quanto sofisticada, num festejo efusivo da arte da mesa.

The Shine collection associates the elegance of metallic sheen with craftwork stoneware. A contrast that provides an effect both rustic and sophisticated, in an effusive celebration of the table art.

Shine asocia de modo vibrante la elegancia del brillo de los metales a piezas en gres artesanal. Un contraste que crea una atmósfera tanto rústica como sofisticada, en una efusiva celebración del arte de la mesa.

La collection Shine associe l'élégance et la luminosité des métaux aux pièces en grès artisanal. Un contraste qui offre une atmosphère aussi rustique que sophistiquée, dans une célébration effusive de l'art de la table.





SHINE 37003579
Travessa Redonda 41
Round Platter 41
Fuente Redonda 41
Plat à Servir Rond 41
△ 2415 gr A 55 mm Ø 409 mm CAP. 2650 ml
△ 5 1/5 lbs H 2 1/8" Ø 16" CAP. 89 3/5 oz



SHINE 37003702
Travessa Oval 40
Oval Platter 40
Fuente Oval 40
Plat à Servir Ovale 40
△ 1358 gr A 26 mm C 261 mm L 406 mm
△ 3 lbs H 1" L 16" W 10 3/4"



SHINE 37003566
Prato Marcador 33
Charger Platter 33
Plato Presentación 33
Assiette à Présentation 33
△ 1111 gr A 26 mm Ø 325 mm
△ 2 3/5 lbs H 1" Ø 12 1/2"



SHINE 37004657
Prato Raso 27,5
Dinner Plate 27,5
Plato Llano 27,5
Assiette Plate 27,5
△ 835 gr A 26 mm Ø 275 mm
△ 1 3/5 lbs H 1" Ø 10 3/4"



SHINE 37003571
Prato Pasta 25
Pasta Plate 25
Plato Pasta 25
Assiette à Pâtes 25
△ 722 gr A 62 mm Ø 254 mm
△ 2 lbs H 2 1/2" Ø 10"



SHINE 37003698
Prato Sopa 25
Soup Plate 25
Plato Hondo 25
Assiette Creuse 25
△ 646 gr A 45 mm Ø 254 mm
△ 1 3/5 lbs H 1 1/8" Ø 11 1/2"



SHINE 37004659
Prato Sobremesa 22
Dessert Plate 22
Plato Postre 22
Assiette à Dessert 22
△ 544 gr A 25 mm Ø 218 mm
△ 1 1/5 lbs H 1" Ø 8 3/4"



SHINE 37004658
Prato Sopa 23
Soup Plate 23
Plato Hondo 23
Assiette Creuse 23
△ 698 gr A 47 mm Ø 232 mm
△ 1 1/2 lbs H 1 3/4" Ø 9 1/2"



SHINE 37003699
Prato Pão 18
Bread & Butter Plate 18
Plato Pan 18
Assiette à Pain 18
△ 346 gr A 24 mm Ø 175 mm
△ 3/4 lbs H 1" Ø 6 9/8"



SHINE 37003577
Saladeira 26
Salad Bowl 26
Ensaladera 26
Saladier 26
△ 1175 gr A 110 mm Ø 265 mm
△ 2 3/5 lbs H 4 1/2" Ø 10 3/4"



SHINE 37003700
Tigela Cereais 625 ml
Cereal Bowl 625 ml
Tazón Cereales 625 ml
Bol Céréales 625 ml
△ 448 gr A 68 mm Ø 162 mm CAP. 625 ml
△ 1 lbs H 2 3/4" Ø 6 1/2" CAP. 21 1/2 oz



SHINE 37003573
Tigela Cereais 560 ml
Cereal Bowl 560 ml
Tazón Cereales 560 ml
Bol Céréales 560 ml
△ 341 gr A 75 mm Ø 160 mm CAP. 560 ml
△ 3/4 lbs H 6 9/8" Ø 6 3/4" CAP. 19 oz



SHINE 37003576
Taça Individual 11
Individual Bowl 11
Taza Individual 11
Bol Individuel 11
△ 176 gr A 52 mm Ø 119 mm CAP. 185 ml
△ 3/5 lbs H 2" Ø 4 3/4" CAP. 6 1/4 oz



WHISPER

Esta coleção em cores escuras, com sussurros de tons mais claros, combina a textura inconfundível do grês com a paleta cromática para proporcionar uma atmosfera misteriosa, patente em cada peça.

This collection in darkened colors, with whispers in lighter shades, combines the unique texture of the stoneware with a chromatic palette to provide a mysterious atmosphere, evident in each piece.

Esta colección en colores oscuros, con pinceladas de tonos más claros, combina la textura inconfundible del grés con la paleta cromática, proporcionando una atmósfera misteriosa, que está presente en cada pieza.

Cette collection de couleurs sombres, avec quelques nuances plus claires, combine la texture unique du grès à la palette chromatique pour créer une atmosphère mystérieuse, évidente dans chaque pièce.





WHISPER 37003655
Travessa Redonda 41
Round Platter 41
Fuente Redonda 41
Plat à Servir Rond 41
△ 2415 gr A 55 mm Ø 409 mm CAP. 2650 ml
△ 5 1/3 lbs H 2 1/8" Ø 16" CAP. 89 3/8 oz



WHISPER 37003652
Travessa Oval 39
Oval Platter 39
Fuente Oval 39
Plat à Servir Ovale 39
△ 1580 gr A 34 mm C 386 mm L 311 mm
△ 3 1/6 lbs H 1 1/8" L 15 1/8" W 12 1/4"



WHISPER 37003653
Prato Marcador 33
Charger Plate 33
Plato Presentación 33
Assiette à Présentation 33
△ 1070 gr A 25 mm Ø 325 mm
△ 2 3/8 lbs H 1" Ø 12 1/8"



WHISPER 37003646
Prato Raso 29
Dinner Plate 29
Plato Llano 29
Assiette Plate 29
△ 952 gr A 27 mm C 285 mm L 278 mm
△ 1 7/8 lbs H 1" L 11 3/8" W 11"



WHISPER 37003649
Prato Pasta 28
Pasta Plate 28
Plato Pasta 28
Assiette à Pâtes 28
△ 830 gr A 43 mm C 275 mm L 262 mm
△ 1 5/8 lbs H 1 3/4" L 10 5/8" W 10 1/8"



WHISPER 37003647
Prato Sobremesa 23
Dessert Plate 23
Plato Postre 23
Assiette à Dessert 23
△ 471 gr A 27 mm C 230 mm L 225 mm
△ 1 lbs H 1" L 9" W 8 9/8"



WHISPER 37003651
Saladeira 26
Salad Bowl 26
Ensaladera 26
Saladier 26
△ 1000 gr A 110 mm Ø 260 mm
△ 2 3/8 lbs H 10 1/4" Ø 4 1/2"



WHISPER 37003648
Tigela 450 ml
Bowl 450 ml
Taza 450 ml
Bol 450 ml
△ 400 gr A 49 mm C 170 mm L 164 mm CAP. 450 ml
△ 9/8 lbs H 2 1/8" L 6 5/8" W 6 5/8" CAP. 15 3/8 oz



WHISPER 37003654
Copo 340 ml
Glass 340 ml
Vaso 340 ml
Tasse 340 ml
△ 364 gr A 106 mm Ø 89 mm CAP. 340 ml
△ 1/2 lbs H 4 1/8" Ø 3 1/2" CAP. 11 1/2 oz

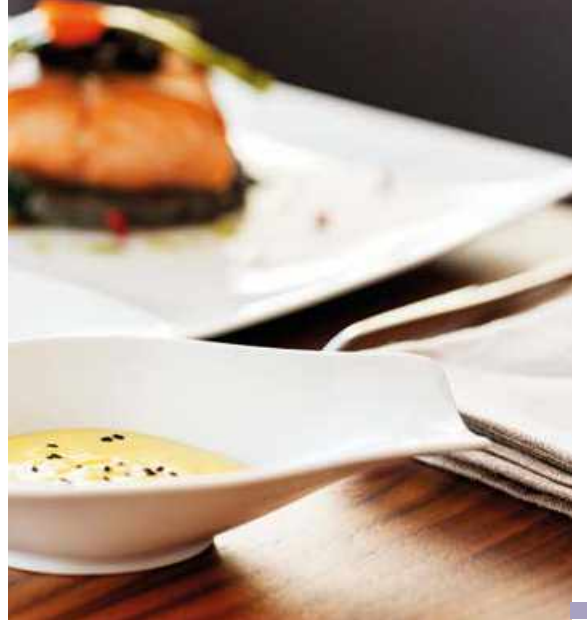

SIGNATURE





CHEFS' COLLECTION



Na concepção de novos pratos de porcelana destinados à alta gastronomia, ou fine dining, a Vista Alegre recorre a quem melhor conhece este universo excepcional: os mais consagrados chefs de cozinha nacionais e internacionais. Desta associação original nascem peças requintadas e exclusivas, que aliam a primazia do design Vista Alegre à criatividade e sentido prático exigidos pela gastronomia de excelência. Um projecto que se estende já a vários países, assinalando uma presença crescente da Vista Alegre no sector e potenciando, através desta relação próxima com os verdadeiros mestres na arte de bem servir, o seu reconhecimento como marca de referência – na inovação, na elegância e na qualidade.

In designing new plates intended for fine dining, Vista Alegre appeals to those who best know this exceptional universe: the most celebrated chefs, nationally and internationally. This original association bears unique and exquisite pieces that combine the primacy of the Vista Alegre design with the creativity and practicality demanded by the cuisine of excellence. A project that spans several countries already, signalling a growing presence of Vista Alegre in the sector and fostering, through this close relationship with the true masters in the art of serving well, its recognition as the benchmark – in innovation, elegance and quality.

En el diseño de nuevos platos de porcelana destinados a la alta gastronomía, Vista Alegre ha recurrido a quien mejor conoce este universo excepcional: los más consagrados chefs de cocina nacionales e internacionales. De esta asociación original han nacido piezas refinadas y exclusivas, que combinan la primacía del diseño Vista Alegre con la creatividad y el sentido práctico exigido por la gastronomía de excelencia. Un proyecto que se extiende ya a varios países, marcando una presencia creciente de Vista Alegre en el sector y potenciando, a través de esta relación cercana con los verdaderos maestros en el arte del buen servir, su reconocimiento como marca de referencia: en la innovación, en la elegancia y en la calidad.

Dans sa conception de nouvelles assiettes en porcelaine, se destinant à la haute cuisine ou gastronomie, Vista Alegre se fait aider de ceux qui connaissent le mieux cet univers exceptionnel: les chefs les plus célèbres à l'échelle nationale et internationale. Cette association originale donne lieu à des pièces uniques et sophistiquées, combinant la primauté du design de Vista Alegre à la créativité et au sens pratique exigés par une gastronomie d'excellence. Ce projet, qui s'est étendu à de nombreux pays, marque la présence croissante de Vista Alegre dans le secteur et favorise, par cette relation étroite avec les véritables maîtres de l'art de bien servir, sa reconnaissance comme marque de référence – dans l'innovation, l'élégance et la qualité.





CHEFS' COLLECTION 21121057
by Chef Michael Grünbacher
Prato Deltha 29
Deltha Plate 29
Plato Deltha 29
Assiette Deltha 29
△ 816 gr A 39 mm Ø 290 mm CAP. 233 ml
△ 1 ¾ lbs H 1 ½" Ø 11 ¾" CAP. 7 ½ oz



CHEFS' COLLECTION 21121593
by Chef Ljubomir Stanisic
Prato Egg
Egg Plate
Plato Egg
Assiette Egg
△ 576 gr A 142 mm Ø 142 mm CAP. 24 ml
△ 1 ¾ lbs H 5 ¾" Ø 5 ¾" CAP. ¾ oz



CHEFS' COLLECTION 21117388
by Chef Benoit Sínthon
Prato Espiral Gourmand 32
Espiral Gourmand Plate 32
Plato Espiral Gourmand 32
Assiette Spiral Gourmand 32
△ 1158 gr A 41 mm Ø 319 mm CAP. 310 ml
△ 2 ¾ lbs H 1 ¾" Ø 12 ¾" CAP. 10 ½ oz



CHEFS' COLLECTION 21111133
by Chef Ricardo Costa
Prato Atlantis 32
Atlantis Plate 32
Plato Atlantis 32
Assiette Atlantis 32
△ 889 gr A 51 mm C 316 mm L 249 mm CAP. 350 ml
△ 2 lbs H 2" L 12 ¾" W 9 ¾" CAP. 11 ¾ oz



CHEFS' COLLECTION 21122196
by Chef Denis Perevoz
Prato Lake 26
Seventy Lake 26
Plato Lake 26
Assiette Lake 26
△ 960 gr A 13 mm C 260 mm
△ 2 ½ lbs H 1 ½" L 10 ¼"



CHEFS' COLLECTION 21124344
by Chef Ruberta Sudbrack
Prato Simple 30
Simple Plate 30
Plato Simple 30
Assiette Simple 30
△ 920 gr A 28 mm Ø 300 mm
△ 2 lbs H 1 ½" Ø 11 ¾"



CHEFS' COLLECTION 21111653
by Chef Rui Paula
Prato Step 33
Step Plate 33
Plato Step 33
Assiette Stpe 33
△ 904 gr A 36 mm C 326 mm L 230 mm
△ 2 lbs H 1 ¾" L 12 ¾" W 9"



CHEFS' COLLECTION 21116523
by Chef Zeffirino
Prato Rotondo com Tampa 30
Rotondo Plate with Lid 30
Plato Rotondo con Tapa 30
Assiette Rotondo avec Cloche 30

CHEFS' COLLECTION 21116371
by Chef Zeffirino
Prato Rotondo 30
Rotondo Plate 30
Plato Rotondo 30
Assiette Rotondo 30
△ 1201 gr A 47 mm Ø 304 mm CAP. 425 ml
△ 2 ¾ lbs H 1 ¾" Ø 12" CAP. 14 ¾ oz



CHEFS' COLLECTION 21111636
by Chef Zeffirino
Tampa Prato Rotondo 30
Lid Rotondo Plate 30
Tapa Plato Rotondo 30
Cloche Assiette Rotondo 30
△ 376 gr A 84 mm Ø 168 mm
△ ¾ lbs H 3 ¾" Ø 6 ¾"

CHEFS' COLLECTION 21114822
by Chef Dieter Koschina
Prato Seventy Nine 36
Seventy Nine Plate 36
Plato Seventy Nine 36
Assiette Seventy None 36
△ 624 gr A 20 mm C 355 mm L 150 mm
△ 1 ¾ lbs H 7 ¾" L 14" W 6"



CHEFS' COLLECTION 21135480
by Chef Luis Pestana
Prato Bordado 31
Bordado Plate 31
Plato Bordado 31
Assiette Bordado 31
△ 940 gr A 21 mm Ø 310 mm
△ 2 lbs H 3/8" Ø 11 3/8"



CHEFS' COLLECTION 21133609
by Chef Hermanos Roca
Prato Bottle Leaf
Plate Bottle Leaf
Plato Bottle Leaf
Assiette Bottle Leaf
△ 226 gr A 43 mm C 276 mm L 78 mm
△ 1/2 lbs H 1 2/3" L 10 5/8" W 3"



CHEFS' COLLECTION 21133587
by Chef Martha Ortiz
Prato Flor Mistica
Plate Flor Mistica
Plato Flor Mistica
Assiette Flor Mistica
△ 810 gr A 38 mm Ø 300 mm
△ 1 3/8 lbs H 1 1/2" Ø 11 3/8"



CHEFS' COLLECTION 21126592
by Chef George Blanc
Prato Lara Glaze
Lara Plate Glaze
Plato Lara Glaze
Assiette Lara Glaze
△ 947 gr A 23 mm Ø 297 mm
△ 2 1/8 lbs H 9/16" Ø 11 3/8"



CHEFS' COLLECTION 21131073
by Chef Vitor Matos
Prato Sopa Glaze 29
Soup Plate Glaze 29
Plato Hondo Glaze 29
Assiette Creuse Glaze 29
△ 770 gr A 61 mm Ø 285 mm
△ 1 3/4 lbs H 2 3/8" Ø 11 3/8"



CHEFS' COLLECTION 21133430
by Chef Justa Nobre
Prato Santola
Plate Santola
Plato Santola
Assiette Santola
△ 478 gr A 64 mm C 194 mm L 78 mm
△ 1 lbs H 2 1/2" L 7 3/8" W 3"

CHEFS' COLLECTION 21126626
by Chef George Blanc
Prato Lara Biscuit
Lara Plate Biscuit
Plato Lara Biscuit
Assiette Lara Biscuit
△ 924 gr A 23 mm Ø 297 mm
△ 2 lbs H 9/16" Ø 11 3/8"



CHEFS' COLLECTION 21117283
by Chef Vitor Matos
Prato Natura Biscuit 33
Natura Plate Biscuit 33
Plato Natura Biscuit 33
Assiette Natura Biscuit 33
△ 1111 gr A 16 mm Ø 330 mm
△ 2 1/2 lbs H 3/8" Ø 13"



CHEFS' COLLECTION 21131072
by Chef Vitor Matos
Prato Sobremesa Biscuit 25
Dessert Plate Biscuit 25
Plato Postre Biscuit 25
Assiette à Dessert Biscuit 25
△ 545 gr A 15 mm Ø 250 mm
△ 1 1/8 lbs H 3/8" Ø 9 3/8"



CHEFS' COLLECTION 21124345
by Chef Luis Baena
Prato Coral Mate 31
Coral Plate Matte 31
Plato Coral Mate 31
Assiette Coral Mate 31
△ 860 gr A 52 mm Ø 311 mm CAP. 550 ml
△ 1 7/8 lbs H 2" Ø 12 1/4" CAP. 18 3/8 oz



CHEFS' COLLECTION 21123388
by Chef Diego Guerrero
Prato Naiz Mate 30
Naiz Plate Mate 30
Plato Naiz Mate 30
Assiette Naiz Mate 30
△ 793 gr A 36 mm Ø 292 mm
△ 1 3/4 lbs H 1 3/8" Ø 11 1/2"

CHEFS' COLLECTION 21117284
by Chef Vitor Matos
Prato Natura Glaze 33
Natura Plate Glaze 33
Plato Natura Glaze 33
Assiette Natura Glaze 33
△ 1154 gr A 14 mm Ø 331 mm
△ 2 3/8 lbs H 3/8" Ø 13"

CHEFS' COLLECTION 21131071
by Chef Vitor Matos
Prato Sobremesa Glaze 25
Dessert Plate Glaze 25
Plato Postre Glaze 25
Assiette à Dessert Glaze 25
△ 545 gr A 15 mm Ø 250 mm
△ 1 1/8 lbs H 3/8" Ø 9 3/8"

CHEFS' COLLECTION 21123798
by Chef Luis Baena
Prato Coral Glaze 31
Coral Plate Glaze 31
Plato Coral Glaze 31
Assiette Coral Glaze 31
△ 860 gr A 52 mm Ø 311 mm CAP. 550 ml
△ 1 7/8 lbs H 2" Ø 12 1/4" CAP. 18 3/8 oz

CHEFS' COLLECTION 21122058
by Chef Diego Guerrero
Prato Naiz 30
Naiz Plate 30
Plato Naiz 30
Assiette Naiz 30
△ 793 gr A 36 mm Ø 292 mm
△ 1 3/4 lbs H 1 3/8" Ø 11 1/2"





COUVERT *by Chef Vitor Sobral*

Couvert é uma elegante coleção desenhada para fazer brilhar as suas entradas. Com uma conceção inspirada na cozinha mediterrânica, que contou com o contributo do Chef Vitor Sobral, *Couvert* permite uma grande diversidade de combinações, adequando-se a todos os ambientes, do mais sofisticado ao mais convencional. Uma gama de doze peças, com várias bases de formato retangular ou quadrado, sobre as quais se podem combinar diversos recipientes de formas arredondadas e com tamanhos variáveis. *Couvert* é a escolha certa para criações gastronómicas com assinatura.

Couvert is an elegant collection designed to brighten your starters. With a conception inspired by Mediterranean cuisine, with input from Chef Vitor Sobral, Couvert allows a wide variety of combinations, adapting to every environment, from the most sophisticated to the most conventional. A range of twelve pieces, with several rectangular and square-shaped bases over which you can combine several containers of rounded shapes and different sizes. Couvert is the right choice for signature culinary creations.

Couvert es una elegante colección diseñada para hacer brillar sus entradas. Con un diseño inspirado en la cocina mediterránea, que contó con la contribución del Chef Vitor Sobral, Couvert permite una gran diversidad de combinaciones, adecuándose a todos los ambientes, desde el más sofisticado al más convencional. Una gama de doce piezas, con varias bases de formato rectangular y cuadrado, sobre las cuales se pueden combinar diversos recipientes redondeados y con tamaños variables. Couvert es la elección adecuada para creaciones gastronómicas con firma.

La collection Couvert est élégante et conçue pour égayer vos entrées. Son design, inspiré de la cuisine méditerranéenne, a compté sur la contribution du Chef Vitor Sobral et permet une grande variété de combinaisons, s'adaptant à tous les environnements, du plus sophistiqué au plus traditionnel. Un service de douze pièces, avec plusieurs assiettes de forme rectangulaire ou carrée, sur lesquelles plusieurs contenants aux formes arrondies et de tailles variables peuvent être posés, assurant de multiples combinaisons. Couvert est le bon choix pour des créations culinaires de signature personnalisée.





COUVERT 21110640
Prato Quadrado 29
Square Plate 29
Plato Cuadrado 29
Assiette Carrée 29
△ 1476 gr A 14 mm C 289 mm L 289 mm
△ 3 ¼ lbs H ¾" L 11 ¾" W 11 ¾"



COUVERT 21110639
Prato Quadrado 24
Square Plate 24
Plato Cuadrado 24
Assiette Carrée 24
△ 886 gr A 13 mm C 239 mm L 239 mm
△ 2 lbs H ½" L 9 ¾" W 9 ¾"



COUVERT 21110630
Bandeja Rectangular com Encaixe 30
Rectangular Tray with Slots 30
Fuente Rectangular con Encaje 30
Plateau Rectangulaire pour Coupelle 30
△ 605 gr A 13 mm C 301 mm L 98 mm
△ 1 ½ lbs H ½" L 11 ¾" W 3 ¾"



COUVERT 21110631
Bandeja Rectangular 30
Rectangular Tray 30
Fuente Rectangular 30
P lateau Rectangulaire 30
△ 587 gr A 13 mm C 301 mm L 99 mm
△ 1 ¾ lbs H ½" L 11 ¾" W 3 ¾"



COUVERT 21110636
Prato Surpresa com Tampa 13
Surprise Dish & Lid 13
Plato Sorpresa con Tapa 13
Assiette Surprise avec Cloche 13

COUVERT 21110672
Prato Surpresa 13
Surprise Dish 13
Plato Sorpresa 13
Assiette Surprise 13
△ 162 gr A 26 mm Ø 129 mm CAP. 35 ml
△ ½ lbs H 1" Ø 5" CAP. 1 ½ oz

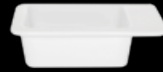

COUVERT 21110637
Prato Acepipes Simples 12
Single Dish 12
Plato Entremés Simples 12
Assiette à Hors d'Oeuvres Simple 12
△ 221 gr A 32 mm C 121 mm L 101 mm
△ ½ lbs H 1 ¼" L 4 ¾" W 4"



COUVERT 21110638
Prato Acepipes Duplo 22
Double Dish 22
Plato Entremés Duplo 22
Assiette à Hors d'Oeuvres Double 22
△ 425 gr A 33 mm C 222 mm L 100 mm
△ 1 lbs H 1 ¾" L 8 ¾" W 4"



COUVERT 21110635
Taça Acepipes 9
Aperitif Bowl 9
Bowl Aperitivos 9
Coupelle Aperitifs 9
△ 103 gr A 41 mm Ø 90 mm
△ ¾ lbs H 1 ¾" Ø 3 ½"



COUVERT 21110667
Suporte Espetadas
Kebab Holder
Soporte Espetadas
Support Brochette
△ 52 gr A 27 mm Ø 55 mm
△ ½ lbs H 1" Ø 2 ¼"



COUVERT 21110632
Copo com Tampa 7cm
Container & Lid 7cm
Vaso con Tapa 7cm
Verrine avec Cloche 7cm
△ 156 gr A 99 mm Ø 56 mm CAP. 115 ml
△ ½ lbs H 3 ¾" Ø 2 ¼" CAP. 3 ¾ oz

COUVERT 21110657
Copo 7cm
Container 7cm
Vaso 7cm
Verrine 7cm
△ 111 gr A 70 mm Ø 56 mm CAP. 115 ml
△ ¼ lbs H 2 ¾" Ø 2 ¼" CAP. 3 ¾ oz

COUVERT 21110665
Tampa Copo
Container Lid
Tapa Vaso
Cloche Verrine
△ 41 gr A 30 mm Ø 54 mm
△ ½ lbs H 1 ¼" Ø 2 ¼"



COUVERT 21110633
Copo com Tampa 5cm
Container & Lid 5cm
Vaso con Tapa 5cm
Verrine avec Cloche 5cm
△ 129 gr A 79 mm Ø 55 mm CAP. 77 ml
△ ¾ lbs H 3 ½" Ø 2 ¼" CAP. 2 ¾ oz

COUVERT 21110662
Copo 5cm
Container 5cm
Vaso 5cm
Verrine 5cm
△ 84 gr A 51 mm Ø 55 mm CAP. 77 ml
△ ½ lbs H 2" Ø 2 ¼" CAP. 2 ¾ oz



COUVERT 21110634
Copo com Tampa 3cm
Container & Lid 3cm
Vaso con Tapa 3cm
Verrine avec Cloche 3cm
△ 102 gr A 57 mm Ø 55 mm CAP. 38 ml
△ ¾ lbs H 2 ¼" Ø 2 ¼" CAP. 1 ¾ oz

COUVERT 21110664
Copo 3cm
Container 3cm
Vaso 3cm
Verrine 3cm
△ 57 gr A 30 mm Ø 55 mm CAP. 38 ml
△ ½ lbs H 1 ¼" Ø 2 ¼" CAP. 1 ¾ oz

COUVERT 21110665
Tampa Copo
Container Lid
Tapa Vaso
Cloche Verrine
△ 41 gr A 30 mm Ø 54 mm
△ ½ lbs H 1 ¼" Ø 2 ¼"

COUVERT 21110665
Tampa Copo
Container Lid
Tapa Vaso
Cloche Verrine
△ 41 gr A 30 mm Ø 54 mm
△ ½ lbs H 1 ¼" Ø 2 ¼"

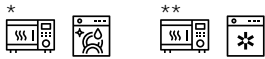

INFINITA

by Carsten Gollnick



Infinita é uma pequena coleção de peças de mesa de formas pouco usuais para serviços de *catering* sensíveis e criativos. As suas superfícies suavemente alongadas e contínuas, sem arestas visíveis, caracterizam o modo formal como os acessórios se afirmam, permitindo empratamentos contemporâneos de uma beleza estilizada. A divisão tradicional entre os bordos e a superfície nos utensílios de mesa em porcelana está aqui completamente posta de lado. O charme dos objetos emana do contraste entre a superfície perfeitamente lisa e refletora, alongada sobre o núcleo interior, e a sofisticação dos pratos elaborados pelos chefs mais criativos.

Infinita is a small collection of unusually shaped porcelain servers for sensitive and creative catering. Ideal for presenting premium, beautifully styled contemporary food concepts. Softly stretched surfaces, without visible edges, with no start or finish, characterise the formal statement the servers are making. The traditional division in porcelain tableware of edge and eating surface is completely done away with here. The charm of the objects stems from the contrast between the perfectly smooth and reflected surface, stretched over the inner core, and the exquisite dishes and sensitive foodstyling of an ambitious chef.

Infinita es una pequeña colección de servicio de mesa de formas poco usuales para servicios de catering sensibles y creativos. Ideal para la presentación de conceptos de alimentación contemporáneos estilizados con la belleza. Superficies alargadas suavemente, sin bordes visibles, sin principio ni fin, caracterizan el modo como el servicio se afirma. La división tradicional en los servicios de mesa de porcelana entre los bordos y la superficie para los alimentos está completamente puesta de lado aquí. El charme de los objetos emana del contraste entre la superficie perfectamente lisa y reflejada, alargada sobre el núcleo interior, y la sofisticación de los platos y estilización de los alimentos de los chefs más creativos.

Infinita est une petite collection de pièces de service en porcelaine aux formes inhabituelles pour les traiteurs sensibles et créatifs. Idéale pour offrir des concepts impeccables et élégants de la cuisine contemporaine. Des surfaces délicatement étirées, sans bords visibles, sans début ni fin, caractérisent la définition formelle des pièces de service. La division traditionnelle de la vaisselle en porcelaine entre le bord et la surface où sont déposés les mets est totalement supprimée ici. Le charme des objets provient du contraste entre la surface parfaitement lisse et épurée, s'étendant sur le centre interne, et les plats raffinés et le style sensible d'un chef ambitieux.





INFINITA* 21121478
 Prato Grande 28
Large Plate 28
Plato Grande 28
Assiette Grand Modèle 28
 △ 1150 gr A 37 mm Ø 286 mm
 △ 2 5/8 lbs H 1 1/8" Ø 11 1/4"



INFINITA* 21131086
 Prato Oval 30
Oval Plate 30
Plato Oval 30
Assiette Ovale 30
 △ 1020 gr A 55 mm C 305 mm L 205 mm
 △ 2 1/4 lbs H 2 1/8" L 12" W 8 1/8"



INFINITA* 21121479
 Prato Pequeno 22
Small Plate 22
Plato Pequeño 22
Assiette Petit Modèle 22
 △ 992 gr A 71 mm Ø 222 mm
 △ 2 1/8 lbs H 2 7/8" Ø 8 3/4"

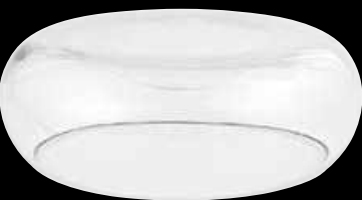

INFINITA** 49000468
 Prato Pequeno 22 Vidro
Small Plate 22 Glass
Plato Pequeño 22 Vidrio
Assiette Petit 22 Verre
 △ 625 gr A 74 mm Ø 130 mm
 △ 1 3/8 lbs H 2 3/8" Ø 5 1/8"



INFINITA* 21131085
 Prato Degustação 14
Tasting Plate 14
Plato Degustación 14
Assiette Dégustation 14
 △ 460 gr A 67 mm Ø 144 mm
 △ 1 lbs H 2 3/8" Ø 5 23/32"



MARÉ ALTA

by Magdalena Kraska



Desenvolvida pela designer polaca Magdalena Kraska, Maré Alta é inspirada na gastronomia e costa portuguesas. O fenómeno da maré alta, isto é, quando a água atinge o nível mais alto, criando um efeito de onda, é representado pela forma dos pratos. Além disso, a superfície dos pratos revela ondas fluidas, elegantes e funcionais, com um brilho intenso.

Maré Alta, developed by the Polish designer Magdalena Kraska, is inspired by Portuguese cuisine and coast line. The high tide phenomena when the water rises to its highest level, forming a wave effect, is represented in the shape of the plates. Moreover, the plating areas reveal elegant and functional fluid waves, that shine intensively.

Maré Alta, desarrollada por la diseñadora polaca Magdalena Kraska, está inspirada en la cocina portuguesa y el litoral. El fenómeno de la marea alta cuando el agua sube a su nivel más alto, formando un efecto de ola, se representa en forma de platos. Además, las áreas de revestimiento revelan ondas fluidas elegantes y funcionales, que brillan intensamente.

Maré Alta, conçu par la designer polonaise Magdalena Kraska, s'inspire de la cuisine et du littoral portugais. La forme des assiettes symbolise le phénomène de la marée haute lorsque l'eau atteint son niveau le plus haut, créant un effet de vague. Par ailleurs, les parties plaquées font apparaître les élégantes vagues d'eau fonctionnelles, et leur éclat intense.





MARÉ ALTA 21135846
Prato Raso 28
Dinner Plate 28
Plato Llano 28
Assiette Plate 28
△ 660 gr A 64 mm C 280 mm L 260 mm
△ 1 ½ lbs H 2 ½" L 11" W 10 ¼"



MARÉ ALTA 21135888
Prato Sobremesa 24
Dessert Plate 24
Plato Postre 24
Assiette Déssert 24
△ 480 gr A 60 mm C 240 mm L 227 mm
△ 1 lbs H 2 ½" L 9 ¾" W 9"



MARÉS

by Carsten Gollnick



Assinada pelo designer alemão Carsten Gollnick, a coleção *Marés* é um tributo à ancestral ligação portuguesa ao mar, honrando em particular a população costeira que se dedica à captura do marisco, atividade intimamente ligada à cultura nacional. Os elementos formais evocam o oceano nos seus diversos estados, o vento ondulando sobre a superfície, as dunas na linha costeira e outras formações de areia. Merece um destaque especial a textura única e inovadora obtida, que se assemelha à areia moldada pelo vento em relevos e contornos dinâmicos. Uma gama que combina fortes aspetos emocionais com a funcionalidade requerida no contexto da hotelaria e da restauração.

Signed by German designer Carsten Gollnick, Marés is a tribute to the Portuguese ancestral connection to the sea, honouring in particular the coastal population that dedicate themselves to catching seafood, an activity closely linked to the national culture. The formal elements evoke the ocean in its different states, the wind rippling over the surface, the shoreline dunes and other sand formations. Worthy of special attention is the unique and innovative texture obtained, which resembles the sand, shaped by the wind in dynamic contours and reliefs. A range that combines strong emotional aspects with the functionality required within the hotel and restaurant sector.

Firmado por el diseñador alemán Carsten Gollnick, la colección Marés es un homenaje a la ancestral conexión portuguesa hacia el mar, honrando en particular la población costera que se dedica a la captura de marisco, negocio estrechamente ligado a la cultura nacional. Los elementos formales evocan el mar en diferentes estados, ondeando al viento sobre la superficie de las dunas litorales y otras formaciones de arena. Merece ser destacada la textura única e innovadora obtenida, que se asemeja a la arena moldeada por el viento con relieves y contornos dinámicos. Una gama que combina aspectos emocionales fuertes con la funcionalidad requerida en el contexto de los hoteles y restaurantes.

Signée par le designer allemand Carsten Gollnick, la collection Marés est un hommage au lien ancestral portugais à la mer, honorant en particulier la population côtière qui vit de la capture des fruits de mer, une activité étroitement liée à la culture nationale. Les éléments formels évoquent l'océan dans ses différents états, le vent ondulant sur la surface, les dunes sur le littoral et d'autres formations de sable. La texture unique et innovante obtenue, qui ressemble à du sable façonné par le vent en des reliefs et contours dynamiques, est l'une des caractéristiques plus marquantes. Une gamme qui associe les aspects émotionnels à la fonctionnalité requise dans le contexte de l'hôtellerie et de la restauration.





MARÉS 21118025
Prato Oval Grande 32
Medium Oval Plate 32
Plato Oval Grande 32
Assiette Ovale Grand Modèle 32
△ 860 gr A 21 mm C 322 mm L 264 mm
△ 1 9/16 lbs H 5/8" L 12 3/8" W 10 3/8"



MARÉS 21118026
Prato Oval Médio 30
Medium Oval Plate 30
Plato Oval Mediano 30
Assiette Ovale Moyen 30
△ 740 gr A 21 mm C 303 mm L 244 mm
△ 1 3/8 lbs H 5/8" L 12" W 9 3/8"



MARÉS 21118334
Travessa Oval Grande 47
Large Oval Platter 47
Fuente Oval Grande 47
Plat à Servir Ovale Grand modèle 47
△ 1380 gr A 23 mm C 470 mm L 240 mm
△ 3 lbs H 1" L 18 1/2" W 9 3/8"



MARÉS 21118059
Travessa Oval Média 40
Medium Oval Platter 40
Fuente Oval Mediana 40
Plat à Servir Ovale Moyen 40
△ 855 gr A 23 mm C 405 mm L 202 mm
△ 1 9/16 lbs H 1" L 16" W 8"



MARÉS 21118028
Prato Quadrado 29
Square Plate 29
Plato Cuadrado 29
Assiette Carrée 29
△ 1181 gr A 22 mm C 297 mm L 297 mm
△ 2 3/8 lbs H 5/8" L 11 3/8" W 11 3/8"



MARÉS 21118029
Prato Quadrado 24
Square Plate 24
Plato Cuadrado 24
Assiette Carrée 24
△ 745 gr A 20 mm C 247 mm L 247 mm
△ 1 3/8 lbs H 5/8" L 9 5/8" W 9 5/8"



MARÉS 21118030
Prato Fundo 29
Deep Plate 29
Plato Hondo 29
Assiette Creuse 29
△ 502 gr A 39 mm C 294 mm L 182 mm CAP. 437 ml
△ 1 1/8 lbs H 1 1/2" L 11 3/8" W 7 1/8" CAP. 14 7/8 oz



MARÉS 21118027
Prato Redondo 29
Round Plate 29
Plato Redondo 29
Assiette Ronde 29
△ 820 gr A 23 mm C 290 mm
△ 2 lbs H 1" ∅ 11 3/8"



MARÉS 21118082
Prato Pasta com Tampa 30
Pasta Plate with Lid 30
Plato Pasta con Tapa 30
Assiette à Pâtes et Cloche 30

MARÉS 21118081
Prato Pasta 30
Pasta Plate 30
Plato Pasta 30
Assiette à Pâtes 30
△ 858 gr A 57 mm ∅ 298 mm CAP. 204 ml
△ 1 9/16 lbs H 2 1/4" ∅ 11 3/4" CAP. 6 5/8 oz



MARÉS 21118035
Tigela Especial Grande 28
Large Special Bowl 28
Taza Especial Grande 28
Coupe Spéciale Grand Modèle 28
△ 520 gr A 50 mm C 287 mm L 157 mm CAP. 268 ml
△ 1 1/8 lbs H 2" L 11 3/8" W 6 1/8" CAP. 9 oz



MARÉS 21118058
Tigela Especial Média 19
Medium Special Bowl 19
Taza Especial Mediana 19
Coupe Spéciale Moyen 19
△ 177 gr A 39 mm C 191 mm L 105 mm CAP. 118 ml
△ 3/8 lbs H 1 1/2" L 7 1/2" W 4 1/8" CAP. 4 oz



MARÉS 21118031
Tigela Grande 22
Large Bowl 22
Taza Grande 22
Coupe Grand Modèle 22
△ 644 gr A 87 mm ∅ 224 mm CAP. 979 ml
△ 1 3/8 lbs H 3 3/8" ∅ 8 7/8" CAP. 33 1/2 oz



MARÉS 21118032
Tigela Média 13
Medium Bowl 13
Taza Mediana 13
Coupe Moyen 13
△ 254 gr A 72 mm ∅ 135 mm CAP. 315 ml
△ 9/16 lbs H 2 5/8" ∅ 5 1/8" CAP. 10 3/8 oz



MARÉS 21118033
Tigela Oval Grande 27
Large Oval Bowl 27
Taza Oval Grande 27
Coupe Ovale Grand Modèle 27
△ 624 gr A 46 mm C 274 mm L 213 mm CAP. 617 ml
△ 1 3/8 lbs H 1 7/8" L 10 3/8" W 8 3/8" CAP. 20 5/8 oz



MARÉS 21118034
Tigela Oval Média 18
Medium Oval Bowl 18
Taza Oval Mediana 18
Coupe Ovale Moyen 18
△ 248 gr A 45 mm C 182 mm L 142 mm CAP. 316 ml
△ 9/16 lbs H 1 7/8" L 7 1/8" W 5 3/8" CAP. 10 3/8 oz



MATRIX *by Bartek Mejor*

Especializado em porcelana contemporânea, o designer polaco Bartek Mejor aplicou toda a sua mestria na coleção *Matrix* para a Vista Alegre, desafiando expectativas no desenho e no processo de fabrico. Utilizando placas construídas a partir de uma série de facetas irregulares, com base numa estrutura cristalina, Mejor uniu criativamente tecnologia e o savoir faire artesanal.

Specializing in contemporary porcelain, the Polish designer Bartek Mejor applied all his mastery in the Matrix collection for Vista Alegre, defying expectations in the design and manufacturing process. Using slates built from a series of irregular facets, with a crystalline structure as base, Mejor creatively combined technology and artisanal savoir faire.

Especializado en porcelana contemporánea, el diseñador polaco Bartek Mejor ha aplicado toda su maestría en la colección Matrix para Vista Alegre, desafiando expectativas en el diseño y en el proceso de fabricación. Utilizando placas construidas a partir de una serie de facetas irregulares, con base en una estructura cristalina, Mejor ha unido de forma creativa la tecnología y el savoir faire artesanal.

Spécialisé dans la porcelaine contemporaine, le designer polonais Bartek Mejor a appliqué toute sa maîtrise dans la collection Matrix pour Vista Alegre, défiant les attentes dans le dessin et le processus de fabrication. En utilisant des plaques construites à partir d'une série de facettes irrégulières, d'une structure cristalline, Mejor a créativement allié la technologie et le savoir-faire artisanal.





MATRIX BISCUIT 21117956
Travessa Oval 42
Oval Platter 42
Fuente Oval 42
Plat à Servir Ovale 42
△ 1661 gr A 28 mm C 422 mm L 360 mm
△ 3 3/5 lbs H 1 1/8" L 16 3/8" W 14 1/8"



MATRIX BISCUIT 21115737
Prato Raso XL 32
Dinner Plate XL 32
Plato Llano XL 32
Assiette Plate XL 32
△ 1028 gr A 22 mm Ø 327 mm
△ 2 1/4 lbs H 9/8" Ø 12 7/8"



MATRIX BISCUIT 21115739
Prato Sopa XL 28
Soup Plate XL 28
Plato Hondo XL 28
Assiette Creuse XL 28
△ 662 gr A 51 mm Ø 278 mm CAP. 291 ml
△ 1 1/2 lbs H 2" Ø 11" CAP. 9 5/8 oz



MATRIX BISCUIT 21115994
Prato Sobrema XL 27
Dessert Plate XL 27
Plato Postre XL 27
Assiette à Dessert XL 27
△ 696 gr A 26 mm Ø 270 mm
△ 1 1/2 lbs H 1" Ø 10 5/8"



MATRIX BISCUIT 21127276
Prato Pão 18
Bread & Butter Plate 18
Plato Pan 18
Assiette à Pain 18
△ 230 gr A 22 mm Ø 180 mm
△ 1/2 lbs H 7/8" Ø 7 1/8"



MATRIX BISCUIT 21117382
Saladeira 25
Salad Bowl 25
Ensaladera 25
Saladier 25
△ 1154 gr A 124 mm Ø 256 mm CAP. 3360 ml
△ 2 1/2 lbs H 4 7/8" Ø 10" CAP. 113 3/5 oz



MATRIX BISCUIT 21117380
Taça Cereais 15
Cereal Bowl 15
Taza Cereales 15
Bol Céréales 15
△ 338 gr A 60 mm Ø 153 mm CAP. 560 ml
△ 3/4 lbs H 2 1/2" Ø 6" CAP. 19 oz



MATRIX BISCUIT 21117378
Châvena Chá com Pires 26cl
Tea Cup & Saucer 26cl
Taza Té con Platillo 26cl
Tasse et Sous-tasse Thé 26cl
△ 305 gr A 64 mm Ø 136 mm CAP. 262 ml
△ 2/3 lbs H 2 1/2" Ø 5 1/2" CAP. 8 9/8 oz



MATRIX BISCUIT 21115740
Châvena Café com Pires 8cl
Coffee Cup & Saucer 8cl
Taza Café con Platillo 8cl
Tasse et Sous-tasse Café 8cl
△ 233 gr A 81 mm Ø 136 mm CAP. 84 ml
△ 1/2 lbs H 3 1/2" Ø 5 1/2" CAP. 2 5/8 oz

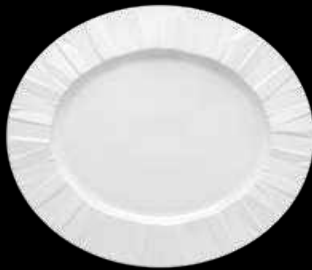

MATRIX GLAZE 21118319
Travessa Oval 42
Oval Platter 42
Fuente Oval 42
Plat à Servir Ovale 42
△ 1661 gr A 28 mm C 422 mm L 360 mm
△ 3 3/5 lbs H 1 1/8" L 16 3/8" W 14 1/8"



MATRIX GLAZE 21117384
Prato Raso XL 32
Dinner Plate XL 32
Plato Llano XL 32
Assiette Plate XL 32
△ 1028 gr A 22 mm Ø 327 mm
△ 2 1/4 lbs H 9/8" Ø 12 7/8"



MATRIX GLAZE 21117387
Prato Sopa XL 28
Soup Plate XL 28
Plato Hondo XL 28
Assiette Creuse XL 28
△ 662 gr A 51 mm Ø 278 mm CAP. 291 ml
△ 1 1/2 lbs H 2" Ø 11" CAP. 9 5/8 oz



MATRIX GLAZE 21117385
Prato Sobrema XL 27
Dessert Plate XL 27
Plato Postre XL 27
Assiette à Dessert XL 27
△ 696 gr A 26 mm Ø 270 mm
△ 1 1/2 lbs H 1" Ø 10 5/8"



MATRIX GLAZE 21127275
Prato Pão 18
Bread & Butter Plate 18
Plato Pan 18
Assiette à Pain 18
△ 245 gr A 22 mm Ø 180 mm
△ 5/8 lbs H 7/8" Ø 7 1/8"



MATRIX GLAZE 21117383
Saladeira 25
Salad Bowl 25
Ensaladera 25
Saladier 25
△ 1154 gr A 124 mm Ø 256 mm CAP. 3360 ml
△ 2 1/2 lbs H 4 7/8" Ø 10" CAP. 113 3/5 oz



MATRIX GLAZE 21117381
Taça Cereais 15
Cereal Bowl 15
Taza Cereales 15
Col Céréales 15
△ 338 gr A 60 mm Ø 153 mm CAP. 560 ml
△ 3/4 lbs H 2 1/2" Ø 6" CAP. 19 oz



MATRIX GLAZE 21117379
Châvena Chá com Pires 26cl
Tea Cup & Saucer 26cl
Taza Té con Platillo 26cl
Tasse et Sous-tasse Thé 26cl
△ 305 gr A 64 mm Ø 136 mm CAP. 262 ml
△ 2/3 lbs H 2 1/2" Ø 5 1/2" CAP. 8 9/8 oz



MATRIX GLAZE 21117386
Châvena Café com Pires 8cl
Coffee Cup & Saucer 8cl
Taza Café con Platillo 8cl
Tasse et Sous-tasse Café 8cl
△ 233 gr A 81 mm Ø 136 mm CAP. 84 ml
△ 1/2 lbs H 3 1/2" Ø 5 1/2" CAP. 2 5/8 oz



MINERAL *by Sylvie Coquet*

Para criar a coleção *Mineral*, Sylvie Coquet inspirou-se em matérias orgânicas, conseguindo obter a textura e o toque desejados graças ao grão particular da porcelana Vista Alegre, que confere a estas peças um caráter mágico. *Mineral* é uma proposta fortemente sensorial, para a qual contribuem igualmente a altura e os jogos de sombras e luz, assim como a forma dos centros dos pratos, redonda ou retangular, possibilitando encenações muito elegantes, que valorizam as receitas dos chefs.

To create the Mineral collection, Sylvie Coquet sought inspiration in organic matter, having found the desired texture and touch in the particular grain of Vista Alegre porcelain, which grant these pieces a magical character. Mineral is a highly sensory piece, to which the height and effects of shadows and light also contributed, as well as the shape of the centres of the plates – round or rectangular, enabling very stylish scenarios that add value to chefs' recipes.

Para crear la colección Mineral, Sylvie Coquet se inspiró en materiales naturales, consiguiendo obtener la textura y el toque deseado gracias al grado particular de la porcelana Vista Alegre, que confiere a estas piezas un carácter mágico. Mineral es una propuesta fuertemente sensorial, para la cual contribuyen igualmente la altura y los juegos de sombras y luz, así como la forma de los centros de los platos, redonda y rectangular, proporcionando escenarios o presentaciones muy elegantes, que valoran las recetas de los chefs.

Pour créer la collection Mineral, Sylvie Coquet s'est inspirée de la matière organique, obtenant la texture et le toucher désirés grâce au grain particulier de la porcelaine Vista Alegre, qui donne à ces pièces un caractère magique. Mineral est une proposition fortement sensorielle, à laquelle la hauteur et les jeux d'ombres et de lumière contribuent également, ainsi que la forme des centres des assiettes, ronde ou rectangulaire, permettant des mises en scène très élégantes, qui mettent en valeur les recettes des chefs.





MINERAL 21122762
Prato Redondo Biscuit 23
Round Plate Biscuit 23
Plato Redondo Biscuit 23
Assiette Ronde Biscuit 23
△ 700 gr A 31 mm Ø 237 mm
△ 1 ½ lbs H 1 ¾" Ø 9 ½"



MINERAL 21123216
Prato Redondo Glaze 23
Round Plate Glaze 23
Plato Redondo Glaze 23
Assiette Ronde Glaze 23
△ 700 gr A 31 mm Ø 237 mm
△ 1 ½ lbs H 1 ¾" Ø 9 ½"



MINERAL 21122763
Prato Retangular Biscuit 23
Rectangular Plate Biscuit 23
Plato Rectangular Biscuit 23
Assiette Rectangulaire Biscuit 23
△ 700 gr A 31 mm Ø 237 mm
△ 1 ½ lbs H 1 ¾" Ø 9 ½"



MINERAL 21123217
Prato Retangular Glaze 23
Rectangular Plate Glaze 23
Plato Rectangular Glaze 23
Assiette Rectangulaire Glaze 23
△ 700 gr A 31 mm Ø 237 mm
△ 1 ½ lbs H 1 ¾" Ø 9 ½"



O! MOON by Santos Bregaña

Neste conjunto de grande simbolismo, o designer basco Santos Bregaña evoca os quatro elementos – fogo, terra, ar e água – através de quatro estratégias geométricas: solar, lunar, eclipse e espiral. Um trabalho concetual que joga com a composição, as proporções, as estruturas e os limites na manipulação do material, potenciando a captação de luz e, conseqüentemente, amplificando as qualidades de todas as receitas. Peças muito distintas unidas por um equilíbrio orgânico, que não deixarão ninguém indiferente.

In this set of great Symbolism, spanish designer Santos Bregaña evokes the four elements - fire, earth, air and water - through four geometric strategies: solar, lunar eclipse and spiral. A conceptual work that plays on the composition, proportions, structures and limits in the handling of the material, providing light and thus amplifying the qualities of all revenues. Very distinct pieces, joined by an organic balance that will leave no-one indifferent.

En este conjunto de gran simbolismo, el diseñador español Santos Bregaña evoca los cuatro elementos – fuego, tierra, aire y agua – a través de cuatro estrategias geométricas: solar, lunar, eclipse y espiral. Un trabajo conceptual que juega con la composición, con las proporciones, las estructuras y los límites en la manipulación del material, potenciando la captación de luz y, por consiguiente, ampliando las cualidades de todas las recetas. Piezas muy diferentes unidas por un equilibrio orgánico, que no dejará a nadie indiferente.

Dans cet ensemble d'un grand symbolisme, le designer espagnol Santos Bregaña évoque les quatre éléments - le feu, la terre, l'air et l'eau - à travers quatre stratégies géométriques: solaire, lunaire, éclipse et spirale. Un travail conceptuel qui joue avec la composition, les proportions, les structures et les limites de la manipulation de la matière, ce qui maximise le captage de la lumière, amplifiant les qualités de toutes les recettes. Des pièces très sophistiquées, unies par un équilibre organique, qui ne laisseront personne indifférent.





O! MOON 21118673
Prato Solar Rectangular 32
Rectangular Solar Plate 32
Plato Solar Rectangular 32
Assiette Solaire Rectangulaire 32
△ 1072 gr A 19 mm C 322 mm L 224 mm
△ 2 3/8 lbs H 3/4" L 12 5/8" W 8 5/8"



O! MOON 21118674
Prato Solar Rectangular Fundo 32
Deep Rectangular Solar Plate 32
Plato Solar Rectangular Hondo 32
Assiette Solaire Rectangulaire Creuse 32
△ 1072 gr A 16 mm C 321 mm L 223 mm
△ 2 3/8 lbs H 5/8" L 12 5/8" W 8 7/8"



O! MOON 21118675
Prato Solar Quadrado Fundo 22
Deep Square Solar Plate 22
Plato Solar Cuadrado Hondo 22
Assiette Solaire Carrée Creuse 22
△ 744 gr A 19 mm C 223 mm L 223 mm
△ 1 5/8 lbs H 3/4" L 8 7/8" W 8 7/8"



O! MOON 21118676
Prato Lunar Concavo 27
Concave Lunar Plate 27
Plato Lunar Côncavo 27
Assiette Lunaire Concave 27
△ 912 gr A 45 mm Ø 277 mm
△ 2 lbs H 1 7/8" Ø 10 5/8"



O! MOON 21118677
Prato Lunar Fundo 27
Deep Lunar Plate 27
Plato Lunar Hondo 27
Assiette Lunaire Creuse 27
△ 815 gr A 57 mm Ø 269 mm CAP. 204 ml
△ 1 5/8 lbs H 2 1/4" Ø 10 3/8" CAP. 6 5/8 oz



O! MOON 21118678
Prato Lunar Fundo 20
Deep Lunar Plate 20
Plato Lunar Hondo 20
Assiette Lunair Creuse 20
△ 452 gr A 44 mm Ø 203 mm CAP. 175 ml
△ 1 lbs H 1 3/4" Ø 8" CAP. 5 5/8 oz



O! MOON 21118679
Prato Eclipse Grande 28
Large Eclipse Plate 28
Plato Eclipse Grande 28
Assiette Éclipse Grand Modèle 28
△ 847 gr A 29 mm Ø 283 mm
△ 1 7/8 lbs H 1 1/2" Ø 11 1/8"



O! MOON 21118680
Prato Eclipse Pequeno 28
Small Eclipse Plate 28
Plato Eclipse Pequeno 28
Assiette Éclipse Petit Modèle 28
△ 755 gr A 28 mm Ø 284 mm
△ 1 3/8 lbs H 1 1/8" Ø 11 1/8"



O! MOON 21118682
Jarro Pequeno 9cl
Small Jug 9cl
Jarra Pequeña 9cl
Pichet Petit Modèle 9cl
△ 99 gr A 77 mm C 67 mm L 60 mm CAP. 103 ml
△ 3/8 lbs H 3" L 2 5/8" W 2 3/8" CAP. 3 1/2 oz



O! MOON 21118685
Jarro Médio 12cl
Medium Jug 12cl
Jarra Mediana 12cl
Pichet Moyen 12cl
△ 150 gr A 104 mm C 93 mm L 37 mm CAP. 126 ml
△ 1/3 lbs H 4 1/8" L 3 3/8" W 1 4/8" CAP. 4 1/4 oz



O! MOON 21118686
Taça Espuma 14 cl
Foam Container 14 cl
Contenedor Espuma 14 cl
Tasse Mousse 14 cl
△ 240 gr A 98 mm Ø 98 mm CAP. 138 ml
△ 5/8 lbs H 3 5/8" Ø 3 5/8" CAP. 6 1/2 oz



O! MOON 21121480
Taça Espuma Pequena 11cl
Foam Container Small 11 cl
Contenedor Espuma Pequeño 11 cl
Tasse Mousse Petit Modèle 11cl
△ 127 gr A 67 mm Ø 79 mm CAP. 114 ml
△ 3/8 lbs H 2 5/8" Ø 3 1/8" CAP. 3 5/8 oz



SATURN by Carsten Gollnick



Saturn assume-se como espaço escultórico, subvertendo a ideia tradicional de prato e transportando-nos para um novo tipo de tridimensionalidade. Graças à sua simetria rotacional e à área do contorno lateral que se estende elegantemente sobre todo o corpo, as criações gastronômicas elevam-se acima da mesa, ganhando outro destaque. Criação do reputado designer alemão Carsten Gollnick, que desafia continuamente a Vista Alegre a superar as limitações no fabrico da porcelana, Saturn estimulará a criatividade dos chefs mais ambiciosos, inspirando sempre novas confeções.

Saturn es en sí mismo un espacio escultórico que desafía la idea tradicional de plato y nos lleva a un nuevo tipo de tridimensionalidad. Gracias a su simetría rotacional y al área del borde lateral, que se extiende elegantemente sobre el cuerpo, las creaciones gastronómicas se elevan sobre la mesa, destacándose aún más. Creada por el reputado diseñador alemán Carsten Gollnick —que continuamente desafía a Vista Alegre a superar las barreras de la elaboración de la porcelana—, Saturn estimulará la creatividad de los chefs más ambiciosos, inspirando siempre nuevos platos.

Saturn se présente comme un espace sculptural, renversant l'idée traditionnelle d'assiette et nous transporte vers un nouveau type de tridimensionnalité. Grâce à sa symétrie rotationnelle et à la zone de contour latéral qui s'étend gracieusement sur toute l'assiette, les créations gastronomiques, en hauteur, sont mises en relief. Une création du renommé designer allemand Carsten Gollnick, qui défie sans cesse Vista Alegre à dépasser les limitations de la fabrication de la porcelaine, Saturn va stimuler la créativité des chefs les plus ambitieux, inspirant toujours de nouveaux plats.

Saturn comes across as a sculptural space, taking hold of the traditional idea of a plate and transporting us into a new type of three-dimensionality. Thanks to rotational symmetry and to the area of the sides that rise up elegantly from the entire surface, gastronomic creations are able to rise up from the table so as to gain further prominence. A creation by the renowned German designer, Carsten Gollnick, who continually challenges Vista Alegre to go past all boundaries in the production of porcelain, Saturn is certain to stimulate the creativity of the most ambitious of chefs, always inspiring new culinary delights.





SATURN 21131017
 Prato 28
 Plate 28
 Plato 28
 Assiette 28
 △ 1280 gr A 42 mm Ø 279 mm
 △ 2 5/8 lbs H 1 2/3" Ø 11"



SATURN 21131016
 Prato 22
 Plate 22
 Plato 22
 Assiette 22
 △ 833 gr A 55 mm Ø 221 mm
 △ 1 5/6 lbs H 2 1/6" Ø 8 5/8"



SILICA GLASS

A coleção *Silica* nasce de um movimento de aproximação da matéria-vidro à matéria-comida-gourmet, atendendo especialmente à vincada dimensão estética desta. Ao longo deste percurso, os objetos nascem em formas que se quiseram sóbrias e acolhedoras, e amadurecem em texturas – memórias de encontros entre o vidro, que nunca esquece, e outras matérias –, sempre guiados pela mão humana, que deixa em cada um deles uma singular riqueza orgânica.

The Silica collection originates from an attempt to bring the concepts of glass and gourmet food together, focusing particularly on the markedly aesthetic nature of the latter. Throughout this process, objects are given practical, albeit welcoming, shapes, and textures where memory-preserving glass is combined with other materials by expert hands, which leave a unique, richly organic imprint in every piece. The resulting set reflects the paradoxical desire to create formal, albeit original pieces, while refraining the creative impulse, so that glass may back out to allow food to take centre stage.

La colección Silica nace de un movimiento de acercamiento de la materia-vidrio a la materia-comida-gourmet, atendiendo especialmente a la evidente dimensión estética de la misma. A lo largo de este recorrido, los objetos nacen con formas que se pretendían sobrias y acogedoras, y maduran en texturas – memorias de los encuentros entre el vidrio, que nunca olvida, y otras materias –, siempre guiados por la mano humana, que deja en cada uno de ellos una singular riqueza orgánica. Por lo tanto, se pretendía un conjunto que se equilibra, por un lado, entre el deseo de la originalidad formal y, por otro, una intencional contención que, en el momento adecuado, hace retroceder estos objetos-vidrio y dejar el protagonismo de la historia a los objetos-alimento y sus autores.

La collection Silica naît d'un mouvement d'approche de la matière-verre et de la matière-aliments-gourmet, avec une référence particulière à la dimension esthétique marquée de cette dernière. Au long de ce parcours, les objets naissent par des formes qui se sont voulues sobres et accueillantes, et murissent en textures – souvenirs de rencontres entre le verre, qui ne s'oublie jamais, et d'autres matières –, toujours guidés par la main humaine, qui laisse en chacun d'eux une richesse biologique unique. On a ainsi voulu créer un ensemble équilibré, d'une part, avec un désir d'originalité dans les formes et, d'autre part, une retenue délibérée qui, au bon moment, oblige ces objets-verre à reculer et à laisser les objets-aliments et ses artisans en premier plan.





SILICA 26002776
 Pentágono Grey
Pentagon Grey
Pentagono Grey
Pentagone Grey
 △ 510 gr C 230 mm L 230 mm
 △ 1 1/8 lbs L 9" W 9"



SILICA 26002777
 Pentágono Brown
Pentagon Brown
Pentagono Brown
Pentagone Brown
 △ 510 gr C 230 mm L 230 mm
 △ 1 1/8 lbs L 9" W 9"

SILICA 26002775
 Pentágono Extra Clear
Pentagon Extra Clear
Pentagono Extra Clear
Pentagone Extra Clear
 △ 510 gr C 230 mm L 230 mm
 △ 1 1/8 lbs L 9" W 9"

SILICA 26002774
 Pentágono Clear
Pentagon Clear
Pentagono Clear
Pentagone Clear
 △ 510 gr C 230 mm L 230 mm
 △ 1 1/8 lbs L 9" W 9"



SILICA 26002779
 Árvore Extra Clear
Tree Extra Clear
Árbol Extra Clear
Arbre Extra Clear
 △ 420 gr C 310 mm L 190 mm
 △ 1 lbs L 12 1/8" W 7 1/2"



SILICA 26002778
 Árvore Clear
Tree Clear
Árbol Clear
Arbre Clear
 △ 420 gr C 310 mm L 190 mm
 △ 1 lbs L 12 1/8" W 7 1/2"



SILICA 26002780
 Árvore Grey
Tree Grey
Árbol Grey
Arbre Grey
 △ 420 gr C 310 mm L 190 mm
 △ 1 lbs L 12 1/8" W 7 1/2"



SILICA 26002781
 Árvore Brown
Tree Brown
Árbol Brown
Arbre Brown
 △ 420 gr C 310 mm L 190 mm
 △ 1 lbs L 12 1/8" W 7 1/2"

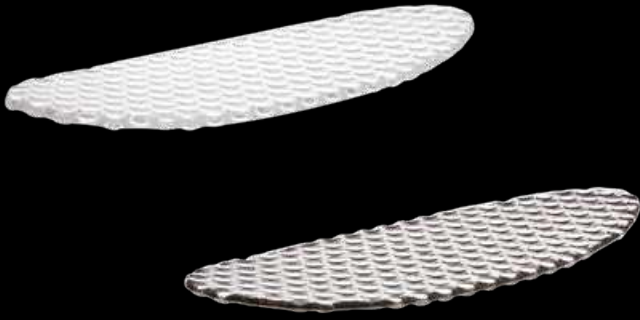

SILICA 26002791
 Travessa Oval Extra Clear
 Oval Platter Extra Clear
 Fuente Oval Extra Clear
 Plat Oval Extra Clear
 △ 360 gr C 290 mm L 115 mm
 △ ¾ lbs L 11 ¾" W 4 ½"

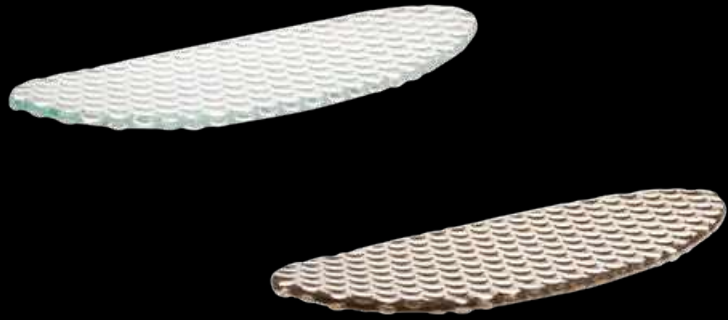

SILICA 26002790
 Travessa Oval Clear
 Oval Platter Clear
 Fuente Oval Clear
 Plat Oval Clear
 △ 360 gr C 290 mm L 115 mm
 △ ¾ lbs L 11 ¾" W 4 ½"

SILICA 26002792
 Travessa Oval Grey
 Oval Platter Grey
 Fuente Oval Grey
 Plat Oval Grey
 △ 360 gr C 290 mm L 115 mm
 △ ¾ lbs L 11 ¾" W 4 ½"

SILICA 26002793
 Travessa Oval Brown
 Oval Platter Brown
 Fuente Oval Brown
 Plat Oval Brown
 △ 360 gr C 290 mm L 115 mm
 △ ¾ lbs L 11 ¾" W 4 ½"



SILICA 26003435
 Bolhas Pequeno Clear
 Bubbles Small Clear
 Burbujas Pequeño Clear
 Bulles Petit Clear
 △ 192 gr C 177 mm L 110 mm
 △ ¾ lbs L 7" W 4 ½"



SILICA 26003436
 Bolhas Pequeno Extra Clear
 Bubbles Small Extra Clear
 Burbujas Pequeño Extra Clear
 Bulles Petit Extra Clear
 △ 192 gr C 177 mm L 110 mm
 △ ¾ lbs L 7" W 4 ½"



SILICA 26003437
 Bolhas Pequeno Grey
 Bubbles Small Grey
 Burbujas Pequeño Grey
 Bulles Petit Grey
 △ 192 gr C 177 mm L 110 mm
 △ ¾ lbs L 7" W 4 ½"



SILICA 26003438
 Bolhas Pequeno Brown
 Bubbles Small Brown
 Burbujas Pequeño Brown
 Bulles Petit Brown
 △ 192 gr C 177 mm L 110 mm
 △ ¾ lbs L 7" W 4 ½"



SILICA 26002788
 Bolhas Grey
 Bubbles Grey
 Burbujas Grey
 Bulles Grey
 △ 480 gr C 340 mm L 130 mm
 △ 1 lbs L 13 ¾" W 5 ½"



SILICA 26002789
 Bolhas Brown
 Bubbles Brown
 Burbujas Brown
 Bulles Brown
 △ 480 gr C 340 mm L 130 mm
 △ 1 lbs L 13 ¾" W 5 ½"



SILICA 26002786
 Bolhas Clear
 Bubbles Clear
 Burbujas Clear
 Bulles Clear
 △ 480 gr C 340 mm L 130 mm
 △ 1 lbs L 13 ¾" W 5 ½"

SILICA 26002787
 Bolhas Extra Clear
 Bubbles Extra Clear
 Burbujas Extra Clear
 Bulles Extra Clear
 △ 480 gr C 340 mm L 130 mm
 △ 1 lbs L 13 ¾" W 5 ½"



SILICA 26002783
 Garrafa Extra Clear
 Bottle Extra Clear
 Botella Extra Clear
 Bouteille Extra Clear
 △ 350 gr C 390 mm L 120 mm
 △ 7/8 lbs L 15 1/8" W 4 3/8"

SILICA 26002782
 Garrafa Clear
 Bottle Clear
 Botella Clear
 Bouteille Clear
 △ 350 gr C 390 mm L 120 mm
 △ 7/8 lbs L 15 1/8" W 4 3/8"

SILICA 26002784
 Garrafa Grey
 Bottle Grey
 Botella Grey
 Bouteille Grey
 △ 350 gr C 390 mm L 120 mm
 △ 7/8 lbs L 15 1/8" W 4 3/8"

SILICA 26002785
 Garrafa Brown
 Bottle Brown
 Botella Brown
 Bouteille Brown
 △ 350 gr C 390 mm L 120 mm
 △ 7/8 lbs L 15 1/8" W 4 3/8"



SILICA 26002796
 Travessa Barco Grey
 Boat Platter Grey
 Fuente Barco Grey
 Plat Bateau Grey
 △ 360 gr C 280 mm L 115 mm
 △ 4/5 lbs L 11" W 4 1/2"



SILICA 26002797
 Travessa Barco Brown
 Boat Platter Brown
 Fuente Barco Brown
 Plat Bateau Brown
 △ 360 gr C 280 mm L 115 mm
 △ 4/5 lbs L 11" W 4 1/2"

SILICA 26002794
 Travessa Barco Clear
 Boat Platter Clear
 Fuente Barco Clear
 Plat Bateau Clear
 △ 360 gr C 280 mm L 115 mm
 △ 4/5 lbs L 11" W 4 1/2"

SILICA 26002795
 Travessa Barco Extra Clear
 Boat Platter Extra Clear
 Fuente Barco Extra Clear
 Plat Bateau Extra Clear
 △ 360 gr C 280 mm L 115 mm
 △ 4/5 lbs L 11" W 4 1/2"



SOUTH

by Carsten Gollnick

A coleção de porcelana SOUTH oferece um design elegante e purista, em perfeito equilíbrio com a funcionalidade exigida em catering e restauração. Por essa razão, é ideal para modernos e elegantes espaços, tanto para sofisticados pequenos-almoços em hotéis boutique, além de ser uma adição especial aos mais requintados espaços fine dining, como um embaixador da arte do café e bebidas quentes.

SOUTH porcelain collection offers an elegant and purist design, in perfect balance with the functionality required in catering and in the restaurant area. Therefore, it is ideal for modern and elegant spaces, both for sophisticated breakfasts in boutique hotels and as an ambassador of the art of coffee and hot beverages, besides being a special addition to the most exquisite fine dining spaces.

La colección de porcelana SOUTH ofrece un diseño elegante y purista, en perfecto equilibrio con la funcionalidad exigida en catering y restauración. Por esa razón, es ideal para espacios modernos y elegantes, tanto para sofisticados desayunos en hoteles boutique, como desempeñando el papel de embajador del arte del café y de las bebidas calientes, además de ser una adición especial para los espacios más refinados de fine dining.

La collection de porcelaine SOUTH propose un design élégant et épuré, l'équilibre parfait pour la fonctionnalité exigée dans la restauration et les services de traiteur. Elle est donc idéale pour les espaces modernes et élégants, pour les petits-déjeuners raffinés des boutiques-hôtels, ou pour apporter un plus aux espaces gastronomiques les plus élégants, en tant qu'ambassadrice de l'art du café et des boissons chaudes.





SOUTH 21133886
Bandeja Quadrada 20
Rectangular Tray 20
Fuente Rectangular 20
Plateau Rectangulaire 20
△ 486 gr A 15 mm C 200 mm
△ 1 lbs H 3/8" L 7 7/8"



SOUTH 21133887
Bandeja Oval 25
Oval Tray 25
Fuente Oval 25
Plateau Ovale 25
△ 365 gr A 15 mm C 245 mm L 141 mm
△ 3/5 lbs H 3/8" L 9 3/8" W 6"



SOUTH 21133874
Açucareiro Oval
Oval Sugar Bowl
Azucarero Oval
Sucrier Ovale
△ 190 gr A 70 mm C 96 mm L 61 mm
△ 3/8 lbs H 2 3/4" L 3 7/8" W 2 3/8"



SOUTH 21133875
Leiteira 16 cl
Milk Jug 16cl
Lechera 16cl
Crémier 16cl
△ 168 gr A 98 mm C 89 mm L 58 mm
△ 3/8 lbs H 3 5/8" L 3 1/8" W 2 3/8"



SOUTH 21133873
Bule 40 cl
Tea Pot 40cl
Tetera 40cl
Théière 40cl
△ 1350 gr A 86 mm C 186 mm L 120 mm
△ 1 lbs H 3 3/8" L 7 1/8" W 4 5/8"



SOUTH 21133870
Copo 20 cl
Glass 20 cl
Vaso 20 cl
Gobelet 20 cl
△ 175 gr A 91 mm Ø 70 mm
△ 3/8 lbs H 3 1/4" Ø 6 3/8"



SOUTH 21133871
Copo 26 cl
Glass 26 cl
Vaso 26 cl
Gobelet 26 cl
△ 175 gr A 72 mm Ø 81 mm
△ 3/8 lbs H 2 5/8" Ø 3 1/8"

SOUTH 21133872
Tampa Copo 26 cl
Glass Lid 26 cl
Tapa Vaso 26cl
Cloche Tasse 26cl
△ 75 gr A 18 mm Ø 81 mm
△ 1/8 lbs H 5/8" Ø 3 1/8"



SOUTH 21134643
Caneca 20 cl
Mug 20 cl
Mug 20 cl
Mug 20 cl
△ 185 gr A 90 mm C 95 mm L 70 mm
△ 3/8 lbs H 3 1/2" L 3 3/4" W 2 3/2" CAP 7 1/2 oz



SOUTH 21133879
Caneca 36 cl
Mug 36 cl
Mug 36 cl
Mug 36 cl
△ 240 gr A 94 mm C 106 mm L 81 mm CAP 328 ml
△ 1/2 lbs H 3 5/8" L 4 1/8" W 3 1/8" CAP 11 oz

SOUTH



SOUTH 21133876
Chávena Chá 20 cl
Tea Cup 20cl
Taza Té 20cl
Tasse Thé 26 cl
△ 150 gr A 60 mm C 106 mm L 80 mm
△ 1/3 lbs H 2 1/3" L 4 1/8" W 3 1/2"

SOUTH 21133883
Par Chávena Chá 20 cl
Tea Cup & Saucer 20cl
Taza Té & Platillo 20cl
Tasse & Sous-tasse Thé 20cl

SOUTH 21133869
Pires Grande 16
Saucer Large 16
Platillo Pequeño 16
Sous-Tasse Petit 16
△ 225 gr A 18 mm Ø 162 mm
△ 1/2 lbs H 3 1/2" Ø 5"



SOUTH 21133878
Chávena Pequeno Almoço 26 cl
Breakfast Cup 26cl
Taza Desayuno 26cl
Taza Petit Déjeuner 26cl
△ 187 gr A 72 mm C 106 mm L 80 mm
△ 3/8 lbs H 2 5/8" L 4 1/8" W 3 1/2"

SOUTH 21133884
Par Chávena Pequeno Almoço 26 cl
Breakfast Cup & Saucer 26cl
Taza Desayuno & Platillo 26cl
Tasse & Sous-tasse Petit Déj. 26cl

SOUTH 21133869
Pires Grande 16
Saucer Large 16
Platillo Pequeño 16
Sous-Tasse Petit 16
△ 225 gr A 18 mm Ø 162 mm
△ 1/2 lbs H 3 1/2" Ø 5"



SOUTH 21133880
Chávena Expresso 7 cl
Expresso Cup 7cl
Taza Expresso 7cl
Tasse Expresso 7cl
△ 106 gr A 78 mm C 57 mm L 56 mm
△ 1/4 lbs H 3" L 2 1/4" W 2 1/8"

SOUTH 21133881
Par Chávena Expresso 7 cl
Expresso Cup & Saucer 7cl
Taza Expresso & Platillo 7cl
Tasse & Sous-tasse Espresso 7cl

SOUTH 21133868
Pires Pequeno 13
Saucer Small 13
Platillo Pequeño 13
Sous-Tasse Petit 13
△ 130 gr A 15 mm Ø 127 mm
△ 3/8 lbs H 3 1/2" Ø 6 3/8"



SOUTH 21133871
Copo 26 cl
Glass 26 cl
Vaso 26 cl
Gobelet 26 cl
△ 175 gr A 72 mm Ø 81 mm
△ 3/8 lbs H 2 5/8" Ø 3 1/8"

SOUTH 21133885
Par Copo 26 cl
Glass 26 cl & Saucer
Vaso 26 cl & Platillo
Gobelet 26 cl & Sous-tasse

SOUTH 21133869
Pires Grande 16
Saucer Large 16
Platillo Pequeño 16
Sous-Tasse Petit 16
△ 225 gr A 18 mm Ø 162 mm
△ 1/2 lbs H 3 1/2" Ø 5"



SOUTH 21133882
Par Chávena Café 13 cl
Coffee Cup & Saucer 13cl
Taza Café & Platillo 13cl
Tasse & Sous-tasse Café 13cl

SOUTH 21133877
Chávena Café 13 cl
Coffee Cup 13cl
Taza Café 13cl
Tasse Café 13cl
△ 130 gr A 83 mm C 57 mm L 81 mm
△ 3/8 lbs H 3 1/4" L 2 1/4" W 3 1/8"

SOUTH 21133868
Pires Pequeno 13
Saucer Small 13
Platillo Pequeño 13
Sous-Tasse Petit 13
△ 130 gr A 15 mm Ø 127 mm
△ 3/8 lbs H 3 1/2" Ø 6 3/8"





TECIDO

by Gonçalo Campos



A delicada ondulação do tecido inspirou esta peça dinâmica. Evocando a suavidade e leveza do têxtil, *Tecido* ganha formas inéditas cuja aparente espontaneidade esconde um intenso trabalho de desenho e moldagem. A naturalidade obtida pelo artista na reprodução das pregas só seria possível recorrendo a porcelana da melhor qualidade.

The textile's delicate waves have inspired this dynamic piece. Evoking the textile's smoothness and lightness, Tecido has a novel shape. The waves of this piece were only possible to obtain by using the best quality porcelain.

La delicada ondulación del tejido ha inspirado a esta pieza dinámica. Evocando la suavidad y la ligereza del textil, Tejido tiene formas inéditas, cuya aparente espontaneidad esconde un intenso trabajo de diseño y moldelaje. La naturalidad obtenida por el artista en la reproducción de las ondulaciones sólo fue posible utilizando porcelana de la mejor calidad.

La douce ondulation du tissu a inspiré cette pièce dynamique. Évoquant la douceur et la légèreté du textile, Tecido gagne des formes inédites dont la spontanéité apparente cache un travail intense de conception et de moulage. Le caractère absolument naturel obtenu par l'artiste dans la reproduction du plissé n'est possible qu'en utilisant la porcelaine de haute qualité.





TECIDO 21117389
 Prato Tecido 28
 Plate Tecido 28
 Plato Tecido 28
 Assiette Tecido 28
 △ 675 gr A 44 mm Ø 285 mm
 △ 1 ½ lbs H 1 ¾" Ø 11 ¾"

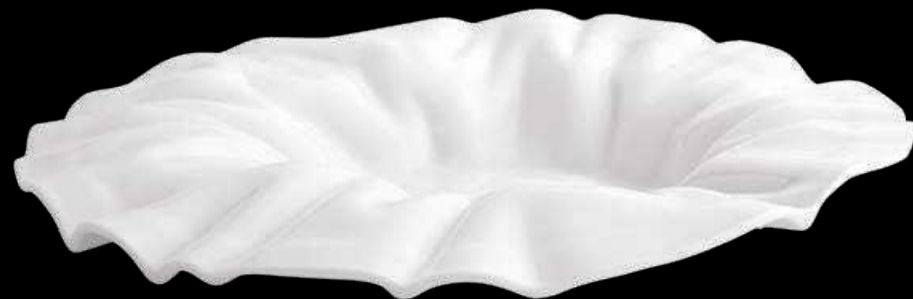

TECIDO 21121416
 Prato Tecido Fundo 28
 Deep Plate Tecido 28
 Plato Tecido Hondo 28
 Assiette Tecido Creuse 28
 △ 675 gr A 44 mm Ø 285 mm
 △ 1 ½ lbs H 1 ¾" Ø 11 ¾"



TEMPTATION *by Sylvie Coquet*

Fazendo uso da tecnologia inovadora da Vista Alegre, Sylvie Coquet criou *Temptation* superando diversas limitações técnicas. Esta coleção surpreendente, constituída por pratos de abas verdadeiramente inclinadas, dotadas de uma textura única e sedosa, e com o interior de diferentes diâmetros, oferece aos chefs inúmeras possibilidades de criação, permitindo obter efeitos estéticos inabituais, mantendo a funcionalidade e polivalência essenciais no segmento de hotelware. Uma proposta irresistivelmente tentadora.

Making use of Vista Alegre's innovative technology, Sylvie Coquet created Temptation, while overcoming several technical limitations. This amazing collection, consisting of plates with a truly tilted brim, endowed with a unique silky texture and different inner diameters, offers chefs countless possibilities for their creations, allowing for unusual aesthetic effects while maintaining the functionality and versatility that are essential to the hotelware segment. An irresistibly tempting piece.

Haciendo uso de la tecnología innovadora de Vista Alegre, Sylvie Coquet creó Temptation superando diversas limitaciones técnicas. Esta colección sorprendente, constituida por platos de asas verdaderamente inclinadas, dotadas de una textura única y sedosa, y con el interior de diferentes diámetros, ofrece a los chefs innumerables posibilidades de creación, permitiendo obtener efectos estéticos poco habituales, manteniendo la funcionalidad y polivalencias esenciales en el sector de hotelware. Una propuesta irresistiblemente tentadora.

Faisant usage de la technologie innovante de Vista Alegre, Sylvie Coquet a créé Temptation en surmontant plusieurs obstacles techniques. Cette collection surprenante, constituée d'assiettes aux rebords fortement inclinés, dotée d'une texture unique et soyeuse, et avec un intérieur de différents diamètres, offre aux chefs de nombreuses possibilités de création, ce qui permet des effets esthétiques exceptionnels, tout en conservant la fonctionnalité et la polyvalence essentielles dans le domaine de l'hôtellerie. Une proposition irrésistiblement alléchante.





TEMPTATION WHITE 21122367
 Prato Centro Pequeno 29
 Plate Small Center 29
 Plato Centro Pequeño 29
 Assiette Petit Bassin 29
 △ 827 gr A 35 mm Ø 292 mm
 △ 1 3/6 lbs H 1 3/8" Ø 11 1/2"



TEMPTATION GOLDEN DROPS 21124295
 Prato Centro Pequeno 29
 Plate Small Center 29
 Plato Centro Pequeño 29
 Assiette Petit Bassin 29
 △ 827 gr A 35 mm Ø 292 mm
 △ 1 3/6 lbs H 1 3/8" Ø 11 1/2"



TEMPTATION WHITE 21122366
 Prato Centro Grande 29
 Plate Large Center 29
 Plato Centro Grande 29
 Assiette Grand Bassin 29
 △ 868 gr A 47 mm Ø 292 mm
 △ 1 9/6 lbs H 1 3/8" Ø 11 1/2"



TEMPTATION GOLDEN DROPS 21124294
 Prato Centro Grande 29
 Plate Large Center 29
 Plato Centro Grande 29
 Assiette Grand Bassin 29
 △ 868 gr A 47 mm Ø 292 mm
 △ 1 9/6 lbs H 1 3/8" Ø 11 1/2"



TEXTURE

by Mieke Cuppen



Como o seu nome indica, este conjunto de pratos desenhados pela holandesa Mieke Cuppen, especialista em tableware, coloca a ênfase na textura. Texture permite brincar com o empratamento, graças a uma superfície que influencia como e onde se coloca a comida. A transição de textura suave e vidrada para não vidrada, além da interação e contrastes criados com outras peças e materiais, contribuem para tornar esta proposta ainda mais sedutora.

Just as its name suggests, this set of plates designed by the Dutch tableware specialist, Mieke Cuppen, places emphasis on texture. Texture allows playing with plating, thanks to a surface that influences how and where food is placed. The transition from a soft glazed texture to one that is unglazed, in addition to the interactions and contrasts arising with other pieces and materials stand to make this piece even more tempting.

Como su propio nombre indica, este conjunto de platos diseñados por la holandesa especialista en vajilla Mieke Cuppen pone el énfasis en la textura. Gracias a una superficie que influencia en cómo y dónde se coloca la comida, Texture permite jugar con el emplatado. La transición de una textura suave y vidriada a otra no vidriada, así como el juego y los contrastes con otras piezas y materiales, hacen de ella una propuesta todavía más atractiva.

Comme son nom l'indique, cet ensemble d'assiettes dessinées par Mieke Cuppen, néerlandaise, spécialiste en vaisselle de table, met l'accent sur la texture. Texture permet de jouer avec la disposition de la table, grâce à une surface qui détermine où et comment sont disposés les mets. La transition de texture douce et vitrée vers une texture non-vitrée, outre l'interaction et les contrastes créés avec d'autres pièces et matériaux, contribue à rendre cette création encore plus séduisante.





TEXTURE 21130974
 Prato Apresentação Escamas 33
Presentation Plate Scales 33
Plato Presentación Escamas 33
Plat Présentation Écailles 33
 △ 1287 gr A 19 mm Ø 331 mm
 △ 2 5/6 lbs H 3/4" Ø 13"



TEXTURE 21130973
 Prato Apresentação Chuva 33
Presentation Plate Rain 33
Plato Presentación Lluvia 33
Plat Présentation Pluie 33
 △ 1287 gr A 19 mm Ø 331 mm
 △ 2 5/6 lbs H 3/4" Ø 13"



TEXTURE 21130971
 Prato Apresentação Chuvinha 33
Presentation Plate Drizzle 33
Plato Presentación Llovizna 33
Plat Présentation Bruine 33
 △ 1287 gr A 19 mm Ø 331 mm
 △ 2 5/6 lbs H 3/4" Ø 13"



TEXTURE 21130972
 Prato Apresentação Crocodilo 33
Presentation Plate Crocodile 33
Plato Presentación Cocodrilo 33
Plat Présentation Crocodile 33
 △ 1287 gr A 19 mm Ø 331 mm
 △ 2 5/6 lbs H 3/4" Ø 13"



THEATRE by FROM

Nos teatro grego antigo a orquestra ocupava um pequeno círculo no palco, rodeado pela audiência. Inspiradas por este cenário, as peças da coleção *Theatre* colocam a criação dos chefs no centro das atenções. A porcelana manufaturada eleva a arte de cozinhar e faz com que cada apresentação constitua um espetáculo em si mesma. A coleção *Theatre* foi desenhada pela FROM, fundada por Cesare Bizzotto, Manuel Amaral Netto e Tobias Nitsche, italiano, português e alemão, respetivamente. Depois de frequentarem o mestrado em Design de Produto na ECAL, Suíça, os três designers juntaram-se para criar o estúdio.

In the ancient Greek's theater, the orchestra was a small circular stage surrounded by the audience. Inspired by this scenery the pieces of Theatre collection put the Chefs creations in the center of attention. The carefully crafted porcelain praises the art of cooking and makes each presentation seen as a true show. The Theatre collection was designed by FROM founded by Cesare Bizzotto, Manuel Amaral Netto and Tobias Nitsche from Italy, Portugal and Germany. After attending a master in product design at ECAL in Switzerland, the three designers got together to create a studio.

En el teatro griego de la antigüedad, la orquesta estaba situada en un pequeño palco circular rodeado por la audiencia. Inspiradas por este escenario las piezas de la colección Theatre colocan las creaciones de los chefs en el centro de mira. La porcelana cuidadosamente elaborada elogia el arte de cocinar transformando cada presentación observada en un verdadero espectáculo. La colección Theatre fue diseñada por FROM fundada por Cesare Bizzotto, Manuel Amaral Netto y Tobias Nitsche provenientes de Italia, Portugal y Alemania. Tras frecuentar el máster en diseño de producto en la ECAL en Suiza, los tres diseñadores se juntaron para crear un estudio.

Dans le théâtre de la Grèce Antique, l'orchestre était une petite estrade circulaire entourée de l'auditoire. Inspirées de ce décor, les pièces de la collection Théâtre placent les chefs cuisiniers au centre de l'attention. La porcelaine, soigneusement conçue, glorifie l'art de la cuisine et transforme chaque exposition en un véritable spectacle. La collection Théâtre a été conçue par FROM, fondé par Cesare Bizzotto, Manuel Amaral Netto et Tobias Nitsche, d'Italie, du Portugal et de l'Allemagne. Après avoir obtenu un master en Design de Produit à l'ECAL, en Suisse, les trois designers se sont associés pour ouvrir un atelier.





THEATRE 21121475
Prato Raso 30
Dinner Plate 30
Plato Llano 30
Assiette Plate 30
△ 764 gr A 28 mm Ø 298 mm
△ 1 3/8 lbs H 1 1/8" Ø 11 3/4"



THEATRE 21124349
Prato Raso Centro Grande 30
Dinner Plate Large Center 30
Plato Llano Centro Grande 30
Assiette Plate Grand Bassin 30
△ 913 gr A 26 mm Ø 299 mm
△ 2 lbs H 1" Ø 11 7/8"



THEATRE 21121656
Prato Aba Larga 27
Large Rim Plate 27
Plato Eclipse Grande 27
Assiette Éclipse Grand Modèle 27
△ 748 gr A 43 mm Ø 273 mm CAP. 111 ml
△ 1 1/2 lbs H 1 3/8" Ø 10 3/4" CAP. 3 3/4 oz



THEATRE 21121477
Prato Sobremesa 25
Dessert Plate 25
Plato Postre 25
Assiette à Dessert 25
△ 571 gr A 26 mm Ø 258 mm
△ 1 1/4 lbs H 1" Ø 10 1/8"



THEATRE 21121476
Prato Sopa 27
Soup Plate 27
Plato Hondo 27
Assiette Creuse 27
△ 726 gr A 46 mm Ø 268 mm CAP. 249 ml
△ 1 3/8 lbs H 1 1/2" Ø 10 5/8" CAP. 8 3/4 oz



STROKE by FROM



GOLD STROKE 21122190
Prato Raso 30
Dinner Plate 30
Plato Llano 30
Assiette Plate 30
△ 764 gr A 28 mm Ø 298 mm
△ 1 2/3 lbs H 1 1/8" Ø 11 3/4"



GOLD STROKE 21122189
Prato Sobremesa 25
Dessert Plate 25
Plato Postre 25
Assiette à Dessert 25
△ 571 gr A 26 mm Ø 258 mm
△ 1 1/4 lbs H 1" Ø 10 1/8"



GOLD STROKE 21123010
Prato Aba Larga 27
Large Rim Plate 27
Plato Degustacion 27
Assiette Éclipse Grand Modèle 27
△ 748 gr A 43 mm Ø 273 mm CAP. 111 ml
△ 1 2/3 lbs H 1 5/8" Ø 10 3/4" CAP. 3 3/4 oz



GOLD STROKE 21122188
Prato Sopa 27
Soup Plate 27
Plato Hondo 27
Assiette Creuse 27
△ 726 gr A 46 mm Ø 268 mm CAP. 249 ml
△ 1 3/5 lbs H 1 1/2" Ø 10 3/8" CAP. 8 3/7 oz



PLATINIUM STROKE 21122193
Prato Raso 30
Dinner Plate 30
Plato Llano 30
Assiette Plate 30
△ 764 gr A 28 mm Ø 298 mm
△ 1 2/3 lbs H 1 1/8" Ø 11 3/4"



PLATINIUM STROKE 21122192
Prato Sobremesa 25
Dessert Plate 25
Plato Postre 25
Assiette à Dessert 25
△ 571 gr A 26 mm Ø 258 mm
△ 1 1/4 lbs H 1" Ø 10 1/8"



PLATINIUM STROKE 21123011
Prato Aba Larga 27
Large Rim Plate 27
Plato Degustacion 27
Assiette Éclipse Grand Modèle 27
△ 748 gr A 43 mm Ø 273 mm CAP. 111 ml
△ 1 2/3 lbs H 1 5/8" Ø 10 3/4" CAP. 3 3/4 oz



PLATINIUM STROKE 21122191
Prato Sopa 27
Soup Plate 27
Plato Hondo 27
Assiette Creuse 27
△ 726 gr A 46 mm Ø 268 mm CAP. 249 ml
△ 1 3/5 lbs H 1 1/2" Ø 10 3/8" CAP. 8 3/7 oz





TRACE

by Carsten Gollnick

A requintada coleção *Trace* sugere uma apresentação flexível e elegante para pratos e refeições especiais. Através do sistema de encaixe dos dois pratos rasos e das duas taças concavas, *Trace* torna possível aos mais ambiciosos chefs apresentar pratos de forma muito elegante e ao mesmo tempo eficaz.

The stylish fine dining collection Trace suggests a very flexible and elegant presentation for gourmet dishes and meals. Through its locating system on the two flat plates and the two conical bowls, Trace allows the most ambitious chefs to present dishes in a very sophisticated and at the same time very effective way.

El exquisito conjunto Trace, permite una presentación flexible y elegante para platos y comidas especiales. A través de un sistema de encaje de los dos platos llanos con las dos tazas cóncavas, Trace permite a cocineros ambiciosos presentar platos de forma elegante y al mismo tiempo eficaz.

L'ensemble raffiné Trace, suggère une présentation flexible et élégante pour des plats et des repas spéciaux. Grâce à son système d'assemblage des deux assiettes et des deux bols, Trace permet aux chefs ambitieux de dresser des plats de façon efficace et élégante.





TRACE 21126246
Prato Aba Pequena 30
Small Rim Plate 30
Plato Ala Pequeña 30
Assiette Petit Bassin 30
△ 1080 gr A 24 mm Ø 301 mm
△ 2 3/8 lbs H 1" Ø 11 9/16"



TRACE 21125798
Prato Aba Larga 30
Large Rim Plate 30
Plato Ala Ancha 30
Assiette Grand Bassin 30
△ 1080 gr A 24 mm Ø 301 mm
△ 2 3/8 lbs H 1" Ø 11 9/16"



TRACE 21125800
Taça Grande Baixa 20
Large Bowl Low 20
Bowl Pequeña Bajo 20
Coupe Grand Modèle Basse 20
△ 601 gr A 35 mm Ø 206 mm CAP. 360 ml
△ 1 1/8 lbs H 1 3/8" Ø 8 1/8" CAP. 12 1/2 oz



TRACE 21125799
Taça Pequena Alta 13
Small Bowl High 13
Bowl Pequeña Alta 13
Coupe Petit Modèle Haute 13
△ 413 gr A 56 mm 134 mm CAP. 284 ml
△ 1 lbs H 2 1/8" Ø 5 3/8" CAP. 9 3/8 oz



TRACE 21125801
Copo com Pires 100ml
Cup & Saucer 100ml
Taza con Platillo 100ml
Gobelet avec Soucoupe 100ml
△ 303 gr A 81 mm Ø 149 mm CAP. 100 ml
△ 2/8 lbs H 3 1/8" Ø 5 9/16" CAP. 3 3/8 oz



TRACE 21134675
Taça Degustação Azeite
Olive Oil Tasting Bowl
Bowl Degustación Aceite Oliva
Bol Dégustation Huile d'Olive
△ 110 gr A 26 mm Ø 78 mm
△ 1/4 lbs H 1" Ø 3"



TRACE 21134656
Taça 7cm Preta
Bowl 7cm Black
Bowl 7cm Black
Bol 7cm Black
△ 88 gr A 32 mm Ø 64 mm
△ 1/8 lbs H 1 1/4" Ø 2 1/2"



VERNISSAGE by Carsten Gollnick

Com as suas formas puras e envolventes, os pratos *Vernissage* transcendem o conceito clássico deste objeto, transformando-se em “plataformas gourmet” destinadas a cozinha criativa, exigente e seletiva. A combinação da forma inusual, de uma aparência simultaneamente leve e forte e da superfície plana de porcelana biscuit polida fazem de *Vernissage* um conjunto realmente único na gastronomia.

With three exceptionally pure and sensuous plate-like objects, Vernissage is not about classical plates but outstanding porcelain presentation for creative and discerning gastronomy. Expectations of conventional plate shapes are completely thrown overboard. Combination of volume and unglazed porcelain flat surface as well as lightness and visual weight has created a decidedly unique object in gastronomy.

La colección Vernissage, con tres piezas extremadamente diferenciadoras y auténticas, huye al concepto de platos clásico, presentando porcelana en una forma original para creaciones gastronómicas creativas y exigentes. La combinación de volumen y superficie plana de porcelana biscuit pulida, así como la ligereza y el peso visual, crearon un objeto único en la gastronomía.

Avec trois objets en forme de assiettes exceptionnellement purs et sensuels, la collection vernissage ne parle pas d'assiettes classiques, mais d'une présentation exceptionnelle de porcelaine pour une gastronomie créative et exigeante. Les attentes des formes d'assiettes conventionnelles sont complètement rejetée. La combinaison du volume et de la surface plane en porcelaine non émaillée, ainsi que de la légèreté et du poids visuel, a créé un objet unique dans la gastronomie.





VERNISSAGE 21131015

Prato 29

Plate 29

Plato 29

Assiette 29

△ 1370 gr A 50 mm Ø 290 mm

△ 3 lbs H 2" Ø 11 3/4"



VERNISSAGE 21131014

Prato 21

Plate 21

Plato 21

Assiette 21

△ 640 gr A 45 mm Ø 210 mm

△ 1 1/2 lbs H 1 7/8" Ø 8 1/4"



VERNISSAGE 21131013

Prato 14

Plate 14

Plato 14

Assiette 14

△ 300 gr A 45 mm Ø 140 mm

△ 2/3 lbs H 1 7/8" Ø 5 1/2"



EXCELLENCE





DOMO

Domo é um modelo contemporâneo em porcelana fina, inspirado nas tendências modernas e minimalistas do design e da arquitetura internacionais. As suas formas elegantes e sofisticadas exibem na perfeição a alta cozinha. Às subtis formas esféricas e arredondadas associam-se detalhes bem vincados, para criar contraste. Os pratos, elegantes e refinados, com curvas suaves e de tamanho generoso, foram criados especificamente para satisfazer os requisitos da arte da apresentação de profissionais de restauração e hotelaria, incluindo os chefs mais exigentes.

Domo is a contemporary model, made of fine porcelain, inspired by the minimalistic trends of modern international design and architecture. Its elegant and sophisticated lines are a perfect symbol of haute cuisine. The subtle spherical and rounded shapes are combined with sharply creased details, creating a visual contrast. These elegant and refined plates, with soft curves and generous size, were specially created to meet the requirements of the art of presentation pursued by catering professionals, including the most demanding chefs.

Domo es un modelo contemporáneo de porcelana fina, inspirado en las tendencias modernas y minimalistas del diseño y la arquitectura internacional. Sus formas elegantes y finas nos muestran a la perfección la alta cocina. A las formas esféricas sutiles y redondeadas se relacionan detalles bien pronunciados, para crear contraste. Los platos, elegantes y refinados, con curvas suaves y de tamaño generoso, se han creado específicamente para satisfacer los requisitos del arte de la presentación de profesionales de la restauración y la hostelería, incluyendo los chefs más exigentes.

Domo est un modèle contemporain de porcelaine fine, inspiré par les tendances minimalistes et modernes de design et d'architecture internationaux. Ses formes élégantes et sophistiquées s'adaptent parfaitement à la haute cuisine. Des détails bien marqués s'associent à des formes subtiles et arrondies pour créer un contraste. Les assiettes, élégantes et raffinées, avec des courbes douces et une taille généreuse, ont été spécifiquement créées pour répondre aux exigences de l'art de la table de professionnels de la restauration et de l'hôtellerie, y compris des chefs plus exigeants.





DOMO 21099998
Travessa Oval Grande 42
Large Oval Platter 42
Fuente Oval Grande 42
Plat à Servir Ovale Grand Modèle 42
△ 1774 gr A 29 mm C 416 mm L 323 mm
△ 4 lbs H 1 1/2" L 16 3/8" W 12 3/4"



DOMO 21100000
Travessa Oval Pequena 35
Small Oval Platter 35
Fuente Oval Pequena 35
Plat à Servir Ovale Petit Modèle 35
△ 1133 gr A 28 mm C 347 mm L 265 mm
△ 2 1/2 lbs H 1 1/8" L 13 3/8" W 10 3/4"



DOMO 21123097
Prato 40
Plate 40
Plato 40
Assiette 40
△ 1871 gr A 36 mm Ø 396 mm
△ 4 1/8 lbs H 1 3/8" Ø 15 3/8"



DOMO 21099992
Prato Marcador 33
Charger Plate 33
Plato Presentación 33
Assiette de Présentation 33
△ 1054 gr A 28 mm Ø 327 mm
△ 2 1/8 lbs H 1 1/8" Ø 12 7/8"



DOMO 21099993
Prato Raso 28
Dinner Plate 28
Plato Llano 28
Assiette Plate 28
△ 689 gr A 25 mm Ø 281 mm
△ 1 1/2 lbs H 1" Ø 11"



DOMO 21100485
Prato Pasta 28
Pasta Plate 28
Plato Pasta 28
Assiette à Pâtes 28
△ 699 gr A 48 mm Ø 281 mm CAP. 429 ml
△ 1 1/2 lbs H 1 5/8" Ø 11" CAP. 14 1/2 oz



DOMO 21099994
Prato Sopa 25
Soup Plate 25
Plato Hondo 25
Assiette Creuse 25
△ 534 gr A 46 mm Ø 252 mm CAP. 285 ml
△ 1 1/8 lbs H 1 4/8" Ø 10" CAP. 9 2/3 oz



DOMO 21099995
Prato Sobremesa 23
Dessert Plate 23
Plato Postre 23
Assiette à Dessert 23
△ 444 gr A 22 mm Ø 229 mm
△ 1 lbs H 9/8" Ø 9"



DOMO 21099996
Prato Doce 17
Bread & Butter Plate 17
Plato Pan 17
Petit Assiette à Dessert 17
△ 222 gr A 17 mm Ø 169 mm
△ 1/2 lbs H 7/8" Ø 6 2/3"



DOMO 21102522
Conserveira
Olive Dish
Rabanera
Ravier
△ 286 gr A 25 mm Ø 195 mm
△ 5/8 lbs H 1" Ø 7 3/4"



DOMO 21102530
Terrina 387cl
Tureen 387cl
Sopera 387cl
Soupière 387cl
△ 2256 gr A 182 mm Ø 293 mm CAP. 3867 ml
△ 5 lbs H 7 1/2" Ø 11 1/2" CAP. 130 3/4 oz



DOMO 21100001
Saladeira Grande 30
Large Salad Bowl 30
Ensaladera Grande 30
Saladier Grand Modèle 30
△ 1614 gr A 103 mm Ø 297 mm CAP. 4432 ml
△ 3 5/8 lbs H 4" Ø 11 3/4" CAP. 149 9/8 oz



DOMO 21102520
Saladeira Pequena 22
Small Salad Bowl 22
Ensaladera Pequena 22
Saladier Petit Modèle 22
△ 780 gr A 77 mm Ø 217 mm CAP. 1555 ml
△ 1 3/8 lbs H 3" Ø 8 1/2" CAP. 52 1/2 oz



DOMO 21100007
Châvena Consomé com Pires 33cl
Consomme Cup & Saucer 33cl
Taza Consomé con Platillo 33cl
Tasse et Soucoupe Bouillon 33cl



DOMO 21100009
Chavena Consomé 33cl
Consomme Cup 33cl
Taza Consomé 33cl
Tasse Bouillon 33cl
△ 175 gr A 50 mm C 170 mm L 120 mm CAP. 334 ml
△ 3/8 lbs H 2" L 6 3/4" W 4 3/4" CAP. 11 3/4 oz



DOMO 21099997
Molheira com Prato 50cl
Sauceboat & Stand 50cl
Salsera con Platillo 50cl
Saucière avec Soucoupe 50cl

DOMO 21110090
Molheira 50cl
Sauceboat 50cl
Salsera 50cl
Saucière 50cl
△ 242 gr A 68 mm C 141 mm L 121 mm CAP. 494 ml
△ 1/2 lbs H 2 3/8" L 5 5/8" W 4 3/4" CAP. 16 5/8 oz

DOMO 21100012
Pires Molheira 50cl
Sauceboat Saucer 50cl
Platillo Salsera 50cl
Soucoupe Saucière 50cl
△ 249 gr A 25 mm Ø 191 mm
△ 5/8 lbs H 1" Ø 7 1/2"

DOMO 21100012
Pires Consomé 33cl
Consomme Saucer 33cl
Platillo Consomé 33cl
Soucoupe Bouillon 33cl
△ 249 gr A 25 mm Ø 191 mm
△ 5/8 lbs H 1" Ø 7 1/2"



DOMO 21117552
Tigela Cereais 14
Cereal Bowl 14
Bowl Cereales 14
Bol Céréales 14
△ 202 gr A 56 mm Ø 140 mm CAP. 445 ml
△ ¾ lbs H 2 ½" Ø 5 ½" CAP. 15 oz



DOMO 21102517
Tigela Cereais 12
Cereal Bowl 12
Bowl Cereales 12
Bol Céréales 12
△ 189 gr A 50 mm Ø 121 mm CAP. 307 ml
△ ¾ lbs H 2" Ø 4 ¾" CAP. 10 ¾ oz



DOMO 21100032
Leiteira 34cl
Milk Jug 34cl
Lechera 34cl
Crémier 34cl
△ 196 gr A 109 mm C 92 mm
L 79 mm CAP. 340 ml
△ ¾ lbs H 4 ¾" L 3 ¾"
W 3 ½" CAP. 11 ½ oz



DOMO 21100033
Açucareiro
Sugar Bowl
Azucarero
Sucrier
△ 290 gr A 83 mm Ø 119 mm CAP. 355 ml
△ ¾ lbs H 3 ¼" Ø 4 ¾" CAP. 12 oz



DOMO 21100030
Bule 132cl
Tea Pot 132cl
Tetera 132cl
Théière 132cl
△ 850 gr A 119 mm C 265 mm
L 180 mm CAP. 1317 ml
△ 1 7/8 lbs H 4 ¾" L 10 ¾" W 7" CAP. 44 ½ oz



DOMO 21124533
Bule Pequeno 40cl
Small Tea Pot 40cl
Tetera Pequeña 40cl
Théière Petit Modèle 40cl
△ 328 gr A 81 mm Ø 192 mm
CAP. 430 ml
△ ¾ lbs H 3 ½" Ø 7 ¾"
CAP. 14 ¾ oz



DOMO 21100031
Cafeteira 99cl
Coffee Pot 99cl
Cafetera 99cl
Cafetière 99cl
△ 768 gr A 246 mm C 173 mm
L 87 mm CAP. 989 ml
△ 1 ¾ lbs H 9 ¾" L 6 ¾"
W 3 ¾" CAP. 33 ¾ oz



DOMO 21118407
Caneca 40cl
Mug 40cl
Mug 40cl
Mug 40cl
△ 253 gr A 112 mm C 114 mm
L 77 mm CAP. 404 ml
△ ¾ lbs H 4 ¾" L 4 ½" W 3" CAP. 13 2/5 oz



DOMO 21102519
Chávena Pequeno Almoço com Pires 40cl
Breakfast Cup & Saucer 40cl
Taza Desayuno con Platillo 40cl
Tasse et Sous-tasse Petit Déjeuner 40cl

DOMO 21103229
Chávena Pequeno Almoço 40cl
Breakfast Cup 40cl
Taza Desayuno 40cl
Tasse Petit Déjeuner 40cl
△ 199 gr A 57 mm C 155 mm L 125 mm CAP. 401 ml
△ ¾ lbs H 2 ¼" L 6 ½" W 5" CAP. 13 ¾ oz



DOMO 21100016
Chávena Chá com Pires 25cl
Tea Cup & Saucer 25cl
Taza Té con Platillo 25cl
Tasse et Sous-tasse Thé 25cl

DOMO 21100024
Chávena Chá 25cl
Tea Cup 25cl
Taza Té 25cl
Tasse Thé 25cl
△ 138 gr A 50 mm C 133 mm
L 105 mm CAP. 251 ml
△ ½ lbs H 2" L 5 ¼"
W 4 ½" CAP. 8 ½ oz



DOMO 21102529
Chávena Café com Pires 13cl
Coffee Cup & Saucer 13cl
Taza Café Cortado con Platillo 13cl
Tasse et Sous-tasse Café 13cl

DOMO 21103231
Chávena Café 13cl
Coffee Cup 13cl
Taza Café Cortado 13cl
Tasse Café 13cl
△ 108 gr A 74 mm C 84 mm L 57 mm CAP. 132 ml
△ ¼ lbs H 3" L 3 ½" W 2 ¼" CAP. 4 ½ oz



DOMO 21116403
Conjunto Azeite e Vinagre
Set Oil & Vinagar
Conjunto Aceite y Vinagre
Ensemble Huilier et Vinaigrier



DOMO 21100027
Chávena Café com Pires 10cl
Coffee Cup & Saucer 10cl
Taza Café con Platillo 10cl
Tasse et Sous-tasse Café 10cl

DOMO 21100029
Chávena Café 10cl
Coffee Cup 10cl
Taza Café 10cl
Tasse Café 10cl
△ 92 gr A 75 mm C 78 mm L 50 mm CAP. 104 ml
△ ½ lbs H 3" L 3" L 2" CAP. 3 ½ oz



DOMO 21102525
Conjunto Saleiro e Pimenteiro
Set Salt & Pepper
Conjunto Salero y Pimentero
Ensemble Salière et Poivrière

DOMO 21103227
Saleiro
Salt
Salero
Salière
△ 79 gr A 86 mm Ø 69 mm
△ ½ lbs H 3 ¾" Ø 2 ¾"

DOMO 21127004
Azeite
Oil
Aceite
Huilier
△ 247 gr A 190 mm C 63 mm
L 52 mm CAP. 286 ml
△ ½ lbs H 7 ½" L 2 ½"
W 2" CAP. 9 ¾ oz

DOMO 21100028
Pires Café 10cl
Coffee Saucer 10cl
Platillo Taza Café 10cl
Sous-tasse Café 10cl
△ 117 gr A 20 mm Ø 130 mm
△ ¼ lbs H ¾" Ø 5 ½"

DOMO 21103228
Pimenteiro
Pepper
Pimentero
Poivrière
△ 79 gr A 86 mm C 69 mm L 69 mm
△ ½ lbs H 3 ¾" L 2 ¾" W 2 ¾"

DOMO 21122057
Vinagre
Vinegar
Vinagre
Vinaigrier
△ 214 gr A 147 mm C 62 mm
L 52 mm CAP. 204 ml
△ ½ lbs H 5 ½" L 2 ½"
W 2" CAP. 6 ¾ oz





MODDO WHITE

A coleção *Modo* inspira-se no mundo natural e na forma humana, encontrando-se, nas suas linhas orgânicas, o equilíbrio entre a harmonia das coisas vivas e a força de um material inerte, a porcelana, cuja beleza surge valorizada. Delicadeza e funcionalidade fundem-se num serviço adequado às mais diversas situações.

Inspired by nature and the human form, the Modo collection stands out by its organic lines, which reflect the perfect balance between harmonious living beings and the strong sobriety of porcelain, whose beauty is thus enhanced. Delicateness and functionality are allied in a set suited to the most diverse occasions.

La colección Modo se inspira en el mundo natural y en la forma humana, encontrándose, en sus líneas orgánicas, el equilibrio entre la armonía de las cosas vivas y la fuerza de un material inerte, la porcelana, cuya belleza adquiere mayor valor. La delicadeza y la funcionalidad se funden en una vajilla adecuada para las más diversas situaciones.

La collection Modo s'inspire du monde naturel et de la forme humaine, trouvant, dans ses lignes organiques, l'équilibre entre l'harmonie des êtres vivants et la force d'un matériau inerte, la porcelaine, dont la beauté ressort valorisée. La finesse et la fonctionnalité fusionnent dans un service adapté aux situations les plus diverses.





BROADWAY WHITE 21085573
Prato Marcador 33
Charger Plate 33
Plato Presentación 33
Assiette à Présentation 33
A 29 mm Ø 331 mm
H 1 1/2" Ø 13"



BROADWAY WHITE 21085576
Prato Raso 28
Dinner Plate 28
Plato Llano 28
Assiette Plate 28
A 33 mm Ø 278 mm
H 1 3/5" Ø 11"



BROADWAY WHITE 21085574
Prato Sopa 23
Soup Plate 23
Plato Hondo 23
Assiette Creuse 23
A 38 mm Ø 193 mm CAP. 533 ml
H 1 1/2" Ø 7 3/5" CAP. 18 oz



BROADWAY WHITE 21085575
Prato Sobremesa 23
Dessert Plate 23
Plato Postre 23
Assiette à Dessert 23
A 28 mm Ø 230 mm
H 1 1/5" Ø 9"



BROADWAY WHITE 21085951
Prato Doce 20
Bread & Butter Plate 20
Plato Pan 20
Petite Assiette à Dessert 20
A 21 mm Ø 197 mm
H 5/6" Ø 7 3/4"



MODO WHITE 21115483
Conserveira
Olive Dish
Rabanera
Ravier
A 61 mm Ø 202 mm
H 2 3/5" Ø 8"



MODO WHITE 21115484
Saladeira 26
Salad Bowl 26
Ensaladera 26
Saladier 26
A 130 mm Ø 255 mm CAP. 3606 ml
H 5 1/8" Ø 10" CAP. 122 oz



MODO WHITE 21115855
Chávana Consomé com Pires 37cl
Consomme Cup & Saucer 37cl
Taza Consomé con Platillo 37cl
Tasse et Soucoupe Bouillon 37cl
A 68 mm Ø 200 mm CAP. 373 ml
H 2 2/3" Ø 7 7/8" CAP. 12 3/5 oz



MODO WHITE 21115856
Molheira com Prato 40cl
Sauceboat & Stand 40cl
Salsera con Platillo 40cl
Saucière avec Soucoupe 40cl
A 89 mm Ø 120 mm CAP. 394 ml
H 3 1/2" Ø 4 3/4" CAP. 13 1/3 oz



MODO WHITE 21115485
Tigela Cereais 14
Cereal Bowl 14
Taza Cereales 14
Bol Céréales 14
A 69 mm Ø 146 mm CAP. 608 ml
H 2 3/4" Ø 5 3/4" CAP. 13 1/3 oz



MODO WHITE 21115482
Leiteira 30cl
Milk Jug 30cl
Lechera 30cl
Crémier 30cl
A 95 mm C 128 mm L 99 mm CAP. 298 ml
H 3 3/4" L 5" W 3 9/16" CAP. 10 oz



MODO WHITE 21115481
Açucareiro
Sugar Bowl
Azucarero
Sucrier
A 169 mm C 231 mm L 141 mm CAP. 298 ml
H 6 2/3" L 9" W 5 5/8" CAP. 10 oz



MODO WHITE 21122820
Prato Bolo con Pé Grande
Large Footed Cake Plate
Plato Pastas con Pie Grande
Plat à Tarte sur Pied Grand Modèle
△ 868 gr A 104 mm Ø 285 mm
△ 2 lbs H 4" Ø 11 3/8"



MODO WHITE 21122821
Prato Bolo con Pé Pequeno
Small Footed Cake Plate
Plato Pastas con Pie Pequeño
Plat à Tarte sur Pied Petit Modèle
△ 266 gr A 68 mm Ø 172 mm
△ 3/5 lbs H 2 3/4" Ø 6 7/8"



MODO WHITE 21115480

Bule 112cl
Tea Pot 112cl
Tetera 112cl
Théière 112cl

A 169 mm C 231 mm L 141 mm CAP. 1126 ml
H 6 7/8" L 9" W 5 5/8" CAP. 38 oz



MODO WHITE 21116199

Cafeteira 113cl
Coffee Pot 113cl
Cafetera 113cl
Cafetière 113cl

A 235 mm C 237 mm L 138 mm CAP. 1132 ml
H 9 1/4" L 9 1/3" W 5 3/4" CAP. 38 3/4 oz



MODO WHITE 21115488

Chávena Chá com Pires 23cl
Tea Cup & Saucer 23cl
Taza Té con Platillo 23cl
Tasse et Sous-tasse Thé 23cl

A 51 mm Ø 165 mm CAP. 231 ml
H 2" Ø 6 1/2" CAP. 7 7/8 oz



MODO WHITE 21115487

Chávena Café com Pires Grande 13cl
Large Coffee Cup & Saucer 13cl
Taza Café Cortado con Platillo 13cl
Tasse et Sous-tasse Café Grand Modèle 13cl

A 75 mm Ø 136 mm CAP. 134 ml
H 3" Ø 5 1/3" CAP. 4 1/2 oz



MODO WHITE 21115486

Chávena Café com Pires 9cl
Coffee Cup & Saucer 9cl
Taza Café con Platillo 9cl
Tasse et Sous-tasse Café Petit Modèle 9cl

A 71 mm Ø 135 mm CAP. 92 ml
H 2 4/8" Ø 5 1/3" CAP. 3 1/8 oz

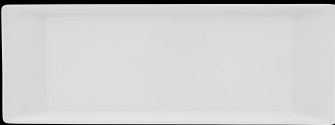

MODO WHITE 21128553

Bandeja Torta 45
Tart Tray 45
Bandeja Torta 45
Plat à Cake 45

△ 1062 gr A 21 mm C 454 mm L 163 mm
△ 2 1/3 lbs H 3/8" L 17 7/8" W 6 3/8"

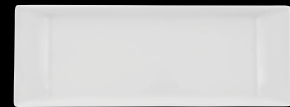

MODO WHITE 21129689

Bandeja Acepipes 32
Appetizer Tray 32
Bandeja Aperitivos 32
Plat à Aperitifs 32

△ 449 gr A 20 mm C 324 mm L 119 mm
△ 1 lbs H 7/8" L 12 7/8" W 4 7/8"





SILK ROAD

by Carsten Gollnick



Criado por Carsten Gollnick, *Silk Road* é um serviço da Vista Alegre que funde o Oriente e Ocidente, numa viagem com as memórias milenares da rota da seda e que se recria, agora, num design que combina o simples e o elegante, o exótico e o funcional, o tradicional e o contemporâneo. Com a qualidade e a excelência da porcelana Vista Alegre.

Carsten Gollnick has created, exclusively for Vista Alegre, a tableware range that derives from the fusion of cultures. Silk Road merges East and West on a journey with thousands of memories that are recreated now in a design that combines the simple and the elegant, the exotic and the functional, the traditional and the contemporary. With the quality and excellence of Vista Alegre porcelain.

Carsten Gollnick creó exclusivamente para Vista Alegre, un servicio, resultado de la fusión de dos culturas. Silk Road, funde Oriente y Occidente en un viaje con historia milenaria, y que ahora lo recrea a través de un diseño que combina lo simple y lo elegante, lo exótico y lo funcional, lo tradicional y lo contemporáneo. Con la calidad y excelencia de la porcelana de Vista Alegre.

Créé par Carsten Gollnick, Silk Road est un service de Vista Alegre qui fusionne l'Orient et l'Occident, dans un voyage à travers les souvenirs millénaires de l'ancienne route de la soie et qui est à présent recréé dans un design qui allie le simple et l'élégant, l'exotique et le fonctionnel, le traditionnel et le contemporain. Avec la qualité et l'excellence de la porcelaine Vista Alegre.





SILK ROAD 21111822
Travessa Retangular Grande 42
Large Rectangular Platter 42
Fuente Rectangular Grande 42
Plat à Servir Rectangulaire Grand Modèle 42
△ 1691 gr A 19 mm C 419 mm L 252 mm
△ 3 ¾ lbs H ¾" L 16 ½" W 10"

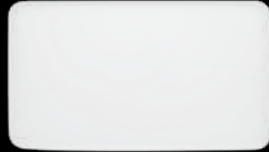

SILK ROAD 21111821
Travessa Retangular Média 35
Medium Rectangular Platter 35
Fuente Rectangular Mediana 35
Plat à Servir Rectangulaire Moyen 35
△ 1067 gr A 18 mm C 346 mm L 202 mm
△ 2 ½ lbs H ¾" L 13 ⅝" W 8"

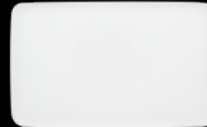

SILK ROAD 21111820
Travessa Retangular Pequena 26
Small Rectangular Platter 26
Fuente Rectangular Pequena 26
Plat à Servir Rectangulaire Petit Modèle 26
△ 603 gr A 17 mm C 263 mm L 164 mm
△ 1 ½ lbs H ¾" L 10 ⅓" W 6 ½"



SILK ROAD 21111811
Prato Marcador 33
Charger Plate 33
Plato Presentación 33
Assiette de Présentation 33
△ 1189 gr A 19 mm Ø 331 mm
△ 2 ½ lbs H ¾" Ø 13"



SILK ROAD 21111812
Prato Raso 30
Dinner Plate 30
Plato Llano 30
Assiette Plate 30
△ 945 gr A 23 mm Ø 299 mm
△ 2 lbs H 1" Ø 11 7/8"



SILK ROAD 21111816
Prato Pasta 28
Pasta Plate 28
Plato Pasta 28
Assiette à Pâtes 28
△ 803 gr A 40 mm Ø 281 mm CAP. 456 ml
△ 1 7/8 lbs H 1 1/4" Ø 11" CAP. 15 3/4 oz



SILK ROAD 21128180
Prato Raso 27
Dinner Plate 27
Plato Llano 27
Assiette Plate 27
△ 695 gr A 22 mm Ø 272 mm
△ 1 ½ lbs H ¾" Ø 12 3/4"



SILK ROAD 21111815
Prato Sopa 25
Soup Plate 25
Plato Hondo 25
Assiette Creuse 25
△ 613 gr A 37 mm Ø 349 mm CAP. 270 ml
△ 1 ½ lbs H 1 ½" Ø 13 ¾" CAP. 9 1/8 oz



SILK ROAD 21111813
Prato Sobremesa 23
Dessert Plate 23
Plato Postre 23
Assiette à Dessert 23
△ 453 gr A 17 mm Ø 228 mm
△ 1 lbs H ¾" Ø 9"



SILK ROAD 21111814
Prato Doce 19
Bread & Butter Plate 19
Plato Pan 19
Petit Assiette à Dessert 19
△ 319 gr A 17 mm Ø 186 mm
△ 5/8 lbs H ¾" Ø 7 ½"



SILK ROAD 21128179
Prato Pão 16
Bread & Butter Plate 16
Plato Pan 16
Assiette à Pain 16
△ 216 gr A 16 mm Ø 16 mm
△ ½ lbs H ¾" Ø 6 ½"



SILK ROAD 21111829
Saladeira Grande 28
Large Salad Bowl 28
Ensaladera Grande 28
Saladier Grand Modèle 28
△ 1612 gr A 86 mm Ø 285 mm CAP. 3867 ml
△ 3 ½ lbs H 3 ½" Ø 11 ¾" CAP. 130 ¾ oz



SILK ROAD 21111819
Prato Retangular Grande 34
Large Rectangular Plate 34
Plato Rectangular Grande 34
Assiette Rectangulaire Grand Modèle 34
△ 899 gr A 21 mm C 341 mm L 209 mm
△ 2 lbs H ¾" L 13 ¾" W 8 ¾"



SILK ROAD 21111818
Prato Retangular Médio 30
Medium Rectangular Plate 30
Plato Rectangular Mediano 30
Assiette Rectangulaire Moyen 30
△ 702 gr A 21 mm C 304 mm L 188 mm
△ 1 5/8 lbs H ¾" L 12" W 7 ¾"



SILK ROAD 21111817
Prato Retangular Pequeno 27
Small Rectangular Plate 27
Plato Rectangular Pequeno 27
Assiette Rectangulaire Petit Modèle 27
△ 552 gr A 21 mm C 272 mm L 171 mm
△ 1 1/8 lbs H ¾" L 10 5/8" W 6 ¾"



SILK ROAD 21111830
Saladeira Pequena 21
Small Salad Bowl 21
Ensaladera Pequena 21
Saladier Petit Modèle 21
△ 850 gr A 67 mm Ø 213 mm CAP. 1640 ml
△ 1 7/8 lbs H 2 ½" Ø 8 ¾" CAP. 55 ½ oz



SILK ROAD 21111831
Tigela Cereais 14
Cereal Bowl 14
Taza Cereales 14
Bol Céréales 14
△ 338 gr A 49 mm Ø 141 mm CAP. 485 ml
△ ¾ lbs H 2" Ø 5 5/8" CAP. 16 3/5 oz



SILK ROAD 21111826
Taça 28cl
Bowl 28cl
Taza 28cl
Coupe 28cl
△ 156 gr A 59 mm Ø 89 mm CAP. 264 ml
△ 1/3 lbs H 2 1/2" Ø 3 1/2" CAP. 9 oz



SILK ROAD 21111827
Taça 13cl
Bowl 13cl
Taza 13cl
Coupe 13cl
△ 118 gr A 48 mm Ø 77 mm CAP. 143 ml
△ 1/4 lbs H 1 5/8" Ø 3" CAP. 4 5/8 oz



SILK ROAD 21111828
Taça 9cl
Bowl 9cl
Taza 9cl
Coupe 9cl
△ 82 gr A 49 mm Ø 62 mm CAP. 100 ml
△ 1/6 lbs H 2" Ø 2 5/8" CAP. 3 3/8 oz



SILK ROAD 21122075
Chávena Consomé com Pires Konic 30cl
Consomme Cup with Saucer Konic 30cl
Taza Consomé con Platillo Konic 30cl
Tasse et Soucoupe Bouillon Konic 30cl

SILK ROAD 21122069
Chávena Consomé Konic 30cl
Consomme Cup Konic 30cl
Taza Consomé Konic 30cl
Tasse Bouillon Konic 30cl
△ 191 gr A 55 mm C 137 mm L 106 mm CAP. 287 ml
△ 3/7 lbs H 2 1/8" L 5 1/8" W 4 1/8" CAP. 9 5/7 oz



SILK ROAD 21111823
Chávena Chá com Pires 26cl
Tea Cup & Saucer 26cl
Taza Té con Platillo 26cl
Tasse et Sous-tasse Thé 26cl

SILK ROAD 21113636
Chávena Chá 26cl
Tea Cup 26cl
Taza Té 26cl
Tasse Thé 26cl
△ 173 gr A 59 mm C 119 mm L 89 mm CAP. 262 ml
△ 3/8 lbs H 2 1/8" L 4 3/8" W 3 1/2" CAP. 8 5/7 oz



SILK ROAD 21111824
Chávena Café com Pires 13cl
Coffee Cup & Saucer 13cl
Taza Café Cortado con Platillo 13cl
Tasse et Sous-tasse Café 13cl

SILK ROAD 21121554
Chávena Café 13cl
Coffee Cup 13cl
Taza Café 13cl
Tasse Café 13cl
△ 123 gr A 48 mm C 101 mm L 77 mm CAP. 146 ml
△ 1/4 lbs H 1 5/8" L 4" W 3" CAP. 5 oz



SILK ROAD 21111825
Chávena Café com Pires 9cl
Coffee Cup & Saucer 9cl
Taza Café con Platillo 9cl
Tasse et Sous-tasse Café 9cl

SILK ROAD 21113881
Chávena Café 9cl
Coffee Cup 9cl
Taza Café 9cl
Tasse Café 9cl
△ 87 gr A 49 mm C 85 mm L 62 mm CAP. 100 ml
△ 1/6 lbs H 2" L 3 1/8" W 2 5/8" CAP. 3 3/8 oz



SILK ROAD 21122071
Chávena Café com Pires Konic 9cl
Coffee Cup with Saucer Konic 9cl
Taza Café con Platillo Konic 9cl
Tasse et Sous-tasse Café Konic 9cl

SILK ROAD 21122065
Chávena Café Konic 9cl
Coffee Cup Konic 9cl
Taza Café Konic 9cl
Tasse Café Konic 9cl
△ 95 gr A 48 mm C 84 mm L 62 mm CAP. 91 ml
△ 1/5 lbs H 1 5/8" L 3 1/8" W 2 5/8" CAP. 3 oz



SILK ROAD 21122072
Chávena Chá com Pires Konic 22cl
Tea Cup with Saucer Konic 22cl
Taza Té con Platillo Konic 22cl
Tasse et Sous-tasse Thé Konic 22cl

SILK ROAD 21122066
Chávena Chá Konic 22cl
Tea Cup Konic 22cl
Taza Té Konic 22cl
Tasse Thé Konic 22cl
△ 164 gr A 64 mm C 116 mm L 89 mm CAP. 219 ml
△ 1/3 lbs H 2 1/2" L 4 4/8" W 3 1/2" CAP. 7 3/5 oz

SILK ROAD 21113633
Pires Café 9cl
Coffee Saucer 9cl
Platillo Café 9cl
Sous-tasse Café Konic 9cl
△ 131 gr A 17 mm Ø 126 mm
△ 1/2 lbs H 3/8" Ø 5"

SILK ROAD 21113633
Pires Café 9cl
Coffee Saucer 9cl
Platillo Café 9cl
Sous-tasse Café Konic 9cl
△ 131 gr A 17 mm Ø 126 mm
△ 1/2 lbs H 3/8" Ø 5"

SILK ROAD 21113634
Pires Chá 26cl
Tea Saucer 26cl
Platillo Té 26cl
Sous-tasse Thé Konic 26cl
△ 211 gr A 15 mm Ø 161 mm
△ 1/2 lbs H 3/8" Ø 6 1/8"





SILK ROAD 21122073
Chávena Chá com Pires Konic Emp. 22cl
Tea Cup with Saucer Konic St. 22cl
Taza Té con Platillo Konic St. 22cl
Tasse et Sous-tasse Thé Konic St. 22cl

SILK ROAD 21122067
Chávena Chá Konic Emp. 22cl
Tea Cup Konic St. 22cl
Taza Té Konic St. 22cl
Tasse Thé Konic St. 22cl
△ 171 gr A 65 mm C 108 mm L 82 mm CAP. 200 ml
△ 3/8 lbs H 2 3/8" L 4 1/4" W 3 3/8" CAP. 6 3/4 oz



SILK ROAD 21122068
Chávena Konic 30cl
Cup Konic 30cl
Taza Konic 30cl
Tasse Konic 30cl
△ 200 gr A 84 mm C 109 mm L 83 mm CAP. 287 ml
△ 9/16 lbs H 3 1/8" L 4 3/8" W 3 1/4" CAP. 9 5/8 oz

SILK ROAD 21113634
Pires Chá 26cl
Tea Saucer 26cl
Platillo Té 26cl
Sous-tasse Thé Konic 26cl
△ 211 gr A 15 mm Ø 161 mm
△ 1/2 lbs H 3/8" Ø 6 1/8"

SILK ROAD 21122074
Chávena Chá Konic com Pires 30cl
Cup Konic with Saucer 30cl
Taza Konic con Platillo 30cl
Tasse et Sous-tasse Konic 30cl

SILK ROAD 21113634
Pires Chá 26cl
Tea Saucer 26cl
Platillo Té 26cl
Sous-tasse Konic 26cl
△ 211 gr A 15 mm Ø 161 mm
△ 1/2 lbs H 3/8" Ø 6 1/8"



SILK ROAD 21122070
Copo Konic 30cl
Glass Konik 30cl
Vaso Konic 30cl
Gobelet Konic 30cl
△ 181 gr A 84 mm Ø 83 mm CAP. 296 ml
△ 3/8 lbs H 3 1/8" Ø 3 1/4" CAP. 10 oz



SILK ROAD 21111835
Caneca 39cl
Mug 39cl
Mug 39cl
Mug 39cl
△ 274 gr A 101 mm C 115 mm L 81 mm CAP. 391 ml
△ 3/8 lbs H 4" L 4 1/2" W 3 1/8" CAP. 13 3/8 oz



SILK ROAD 21111833
Leiteira 25cl
Milk Jug 25cl
Lechera 25cl
Crémier 25cl
△ 204 gr A 62 mm C 135 mm L 89 mm CAP. 246 ml
△ 9/16 lbs H 2 3/8" L 5 1/8" W 3 1/2" CAP. 8 1/3 oz



SILK ROAD 21111834
Açucareiro
Sugar Bowl
Azucarero
Sucrier
△ 257 gr A 78 mm Ø 90 mm CAP. 213 ml
△ 9/16 lbs H 3" Ø 3 1/2" CAP. 7 1/2 oz



SILK ROAD 21111832
Bule 111cl
Tea Pot 111cl
Tetera 111cl
Théière 111cl
△ 726 gr A 100 mm C 244 mm L 155 mm CAP. 1110 ml
△ 1 3/8 lbs H 4" L 9 3/8" W 6 1/8" CAP. 37 1/2 oz





FORNO





AZURE



AZURE BAKEWARE 38002262
Assadeira Oval com Asas 48
Oval Roaster with handles 48
Fuente Horno Oval con Alas 48
Plat à Four Ovale avec Poignées 48
A 60 mm C 480 mm L 270 mm
H 2 3/8" L 18 5/8" W 10 5/8"



AZURE BAKEWARE 38002263
Assadeira Oval com Asas 41
Oval Roaster with handles 41
Fuente Horno Oval con Alas 41
Plat à Four Ovale avec Poignées 41
A 50 mm C 415 mm L 150 mm
H 2" L 16 1/2" W 5 5/8"



AZURE BAKEWARE 38002264
Assadeira Oval com Asas 36
Oval Roaster with handles 36
Fuente Horno Oval con Alas 36
Plat à Four Ovale avec Poignées 36
A 60 mm C 360 mm L 200 mm
H 2 3/8" L 14 1/8" W 7 7/8"



AZURE BAKEWARE 38002265
Assadeira Oval com Asas 25
Oval Roaster with handles 25
Fuente Horno Oval con Alas 25
Plat à Four Ovale avec Poignées 25
A 50 mm C 245 mm L 140 mm
H 2" L 9 5/8" W 5 1/2"



BUFFET



BUFFET 38001466 - GN2A
 Buffet Rectangular Alta 33
 Rectangular Buffet Tall 33
 Buffet Rectangular Ancha 33
 Pièce Buffet Rectangulaire Haute 33
 A 100 mm C 325 mm L 265 mm
 H 4" L 12 4/8" W 10 3/8"



BUFFET 38001465 - GN2B
 Buffet Rectangular Baixa 33
 Rectangular Buffet Short 33
 Buffet Rectangular Baja 33
 Pièce Buffet Rectangulaire Basse 33
 A 60 mm C 325 mm L 265 mm CAP. 2379 ml
 H 2 1/8" L 12 4/8" W 10 3/8" CAP. 80 3/8 oz



BUFFET 38000967 - GN2T
 Tampa
 Lid
 Tapa
 Cloche
 A 50 mm C 325 mm L 265 mm
 H 2" L 12 4/8" W 10 3/8"



BUFFET 38000917 - GN1B
 Buffet Rectangular Baixa 53
 Rectangular Buffet Short 53
 Buffet Rectangular Baja 53
 Pièce Buffet Rectangulaire Basse 53
 A 60 mm C 530 mm L 325 mm CAP. 7000 ml
 H 2 1/8" L 20 9/8" W 12 4/8" CAP. 236 3/8 oz



BUFFET 38001468 - GN3A
 Buffet Rectangular Alta 33
 Rectangular Buffet Tall 33
 Buffet Rectangular Ancha 33
 Pièce Buffet Rectangulaire Haute 33
 A 100 mm C 325 mm L 176 mm CAP. 3800 ml
 H 4" L 12 4/8" W 7" CAP. 128 1/2 oz



BUFFET 38001467 - GN3B
 Buffet Rectangular Baixa 33
 Rectangular Buffet Short 33
 Buffet Rectangular Baja 33
 Pièce Buffet Rectangulaire Basse 33
 A 60 mm C 325 mm L 176 mm CAP. 1356 ml
 H 2 1/8" L 12 4/8" W 7" CAP. 45 6/8 oz



BUFFET 38001005 - GN3T
 Tampa
 Lid
 Tapa
 Cloche
 A 50 mm C 325 mm L 176 mm
 H 2" L 12 4/8" W 7"



BUFFET 38001470 - GN4A
 Buffet Rectangular Alta 18
 Rectangular Buffet Tall 18
 Buffet Rectangular Ancha 18
 Pièce Buffet Rectangulaire Haute 18
 A 100 mm C 176 mm L 162 mm
 H 4" L 7" W 6 3/8"



BUFFET 38001469 - GN4B
 Buffet Rectangular Baixa 18
 Rectangular Buffet Short 18
 Buffet Rectangular Baja 18
 Pièce Buffet Rectangulaire Basse 18
 A 60 mm C 176 mm L 162 mm CAP. 588 ml
 H 2 1/8" L 7" W 6 3/8" CAP. 19 9/8 oz



BUFFET 38001032 - GN4T
 Tampa
 Lid
 Tapa
 Cloche
 A 50 mm C 176 mm L 162 mm
 H 2" L 7" W 6 3/8"



CUISINE



CUISINE 38000068 - B0
Assadeira Oval 39,5
Oval Roaster 39,5
Fuente Horno Oval 39,5
Plat à Four Ovale 39,5
A 40 mm C 395 mm L 275 mm
H 2 3/4" L 15 3/8" W 10 5/8"



CUISINE 38001531 - B1A
Assadeira Oval 37
Oval Roaster 37
Fuente Horno Oval 37
Plat à Four Ovale 37
A 65 mm C 365 mm L 255 mm CAP. 3140 ml
H 2 5/8" L 14 3/8" W 10" CAP. 106 1/2 oz



CUISINE 38000022 - B1
Assadeira Oval 33
Oval Roaster 33
Fuente Horno Oval 33
Plat à Four Ovale 33
A 55 mm C 325 mm L 225 mm CAP. 2330 ml
H 2 1/8" L 12 3/8" W 8 5/8" CAP. 78 3/8 oz



CUISINE 38001536 - B3
Assadeira Oval 30
Oval Roaster 30
Fuente Horno Oval 30
Plat à Four Ovale 30
A 55 mm C 300 mm L 215 mm CAP. 1920 ml
H 2 1/8" L 11 3/8" W 8 1/2" CAP. 65 oz



CUISINE 38001534 - B2
Assadeira Oval 29
Oval Roaster 29
Fuente Horno Oval 29
Plat à Four Ovale 29
A 55 mm C 285 mm L 195 mm CAP. 1680 ml
H 2 1/8" L 11 3/8" W 7 7/8" CAP. 56 3/8 oz



CUISINE 38000060 - B4
Assadeira Oval 25
Oval Roaster 25
Fuente Horno Oval 25
Plat à Four Ovale 25
A 50 mm C 245 mm L 165 mm CAP. 1040 ml
H 2" L 9 3/8" W 6 1/2" CAP. 35 1/8 oz



CUISINE 38000667 - OB7B
Assadeira Rectangular Grande
Large Rectangular Roaster
Fuente Horno Rectangular Grande
Plat à Four Rectangulaire Grand Modèle
A 80 mm C 428 mm L 240 mm CAP. 4740 ml
H 3 1/8" L 16 5/8" W 9 3/8" CAP. 160 7/8 oz



CUISINE 38000086 - B7
Assadeira Rectangular 31
Rectangular Roaster 31
Fuente Horno Rectangular 31
Plat à Four Rectangulaire 31
A 55 mm C 310 mm L 245 mm CAP. 2810 ml
H 2 1/8" L 12 1/8" W 9 7/8" CAP. 95 oz



CUISINE 38000103 - B7A
Assadeira Rectangular 27
Rectangular Roaster 27
Fuente Horno Rectangular 27
Plat à Four Rectangulaire 27
A 50 mm C 265 mm L 205 mm CAP. 1780 ml
H 2" L 10 3/8" W 8" CAP. 60 1/8 oz



CUISINE 38000114 - B7C
Assadeira Rectangular 24
Rectangular Roaster 24
Fuente Horno Rectangular 24
Plat à Four Rectangulaire 24
A 50 mm C 235 mm L 185 mm CAP. 1230 ml
H 2" L 9 1/4" W 7 3/8" CAP. 41 3/8 oz



CUISINE 38000118 - B22
 Assadeira Quadrada 23
 Square Roaster 23
 Fuente Horno Cuadrada 23
 Plat à Four Carré 23
 A 55 mm C 230 mm L 230 mm CAP. 1820 ml
 H 2 1/8" L 9" W 9" CAP. 61 1/2 oz



CUISINE 38000132 - B22A
 Assadeira Quadrada 16
 Square Roaster 16
 Fuente Horno Cuadrada 16
 Plat à Four Carré 16
 A 40 mm C 160 mm L 160 mm CAP. 550 ml
 H 1 1/2" L 6 3/4" W 6 3/4" CAP. 18 3/5 oz



CUISINE 38000376 - L12
 Tarteira 29
 Flan Dish 29
 Tortera 29
 Moule à Tarte 29
 A 42 mm C 290 mm L 290 mm CAP. 2050 ml
 H 1 3/8" L 11 3/8" W 11 3/8" CAP. 69 1/3 oz



CUISINE 38000395 - L11
 Tarteira 26
 Flan Dish 26
 Tortera 26
 Moule à Tarte 26
 A 40 mm C 260 mm L 260 mm CAP. 1630 ml
 H 1 1/2" L 10 1/4" W 10 1/4" CAP. 55 1/2 oz



CUISINE 38001567 - L16
 Tarteira 22
 Flan Dish 22
 Tortera 22
 Moule à Tarte 22
 A 38 mm C 215 mm L 215 mm
 H 1 1/2" L 8 1/2" W 8 1/2"



CUISINE 38000412 - L14
 Tarteira 12
 Flan Dish 12
 Tortera 12
 Moule à Tarte 12
 A 30 mm C 120 mm L 120 mm
 H 1 1/8" L 4 3/4" W 4 3/4"



CUISINE 38001152 - F17A
 Caçarola Redonda 25
 Round Casserole 25
 Cacerola Redonda 25
 Cocotte Ronde 25
 A 110 mm C 250 mm L 250 mm CAP. 2760 ml
 H 4 1/8" L 9 5/8" W 9 5/8" CAP. 93 1/3 oz



CUISINE 38001147 - F17
 Caçarola Redonda 20
 Round Casserole 20
 Cacerola Redonda 20
 Cocotte Ronde 20
 A 100 mm C 205 mm L 205 mm CAP. 1525 ml
 H 4" L 8" W 8" CAP. 51 1/4 oz



CUISINE 38000347 - L10B
 Souflé 23
 Soufflé 23
 Souflé 23
 Soufflé 23
 A 92 mm C 230 mm L 230 mm CAP. 2760 ml
 H 3 3/8" L 9" W 9" CAP. 93 1/3 oz



CUISINE 38000354 - L10
 Souflé 20
 Soufflé 20
 Souflé 20
 Soufflé 20
 A 90 mm C 195 mm L 195 mm CAP. 2100 ml
 H 3 1/2" L 7 3/4" W 7 3/4" CAP. 71 oz



CUISINE 38000368 - L10A
 Souflé 16
 Soufflé 16
 Souflé 16
 Soufflé 16
 A 75 mm C 155 mm L 155 mm CAP. 1070 ml
 H 3" L 6 1/8" W 6 1/8" CAP. 36 1/6 oz



CUISINE 38000424 - L9
 Ramequim
 Ramekin
 Ramequin
 Ramequin
 A 45 mm C 90 mm L 90 mm CAP. 170 ml
 H 1 3/8" L 3 1/2" W 3 1/2" CAP. 5 3/4 oz



CUISINE 38001550 - BSA23
 Saladeira 23
 Salad Bowl 23
 Ensaladera 23
 Saladier 23
 A 100 mm C 230 mm L 230 mm
 H 4" L 9" W 9"



CUISINE 38001554 - BSA14
 Saladeira 14
 Salad Bowl 14
 Ensaladera 14
 Saladier 14
 A 60 mm C 140 mm L 140 mm
 H 2 1/8" L 5 1/2" W 5 1/2"



CUISINE 38001703 - BDI32
 Travessa Oval Dividida 32
Divided Dish 32
Fuente Oval con Divisiones 32
Plate Ovale Divisé 32
 A 40 mm C 320 mm L 175 mm
 H 1 1/2" L 12 3/4" W 6 5/8"



CUISINE 38001701 - BDI28
 Travessa Oval Dividida 29
Divided Dish 29
Fuente Oval con Divisiones 29
Plat Ovale Divisé 29
 A 40 mm C 285 mm L 155 mm
 H 1 1/2" L 11 3/8" W 6 1/8"



CUISINE 38000145 - B23C
 Prato para Gratinados 32
Augratin 32
Plato Gratinados 32
Plat à Gratin 32
 A 40 mm C 320 mm L 165 mm
 H 1 1/2" L 12 3/8" W 6 1/2"



CUISINE 38001546 - B23B
 Prato para Gratinados 28
Augratin 28
Plato Gratinados 28
Plat à Gratin 28
 A 40 mm C 280 mm L 150 mm CAP. 120 ml
 H 1 1/2" L 11" W 6" CAP. 4 oz



CUISINE 38000163 - B23A
 Prato para Gratinados 25
Augratin 25
Plato Gratinados 25
Plat à Gratin 25
 A 40 mm C 250 mm L 140 mm
 H 1 1/2" L 9 3/8" W 5 1/2"



CUISINE 38001530 - B23
 Prato para Gratinados 23
Augratin 23
Plato Gratinados 23
Plat à Gratin 23
 A 30 mm C 225 mm L 120 mm
 H 1 1/8" L 8 5/8" W 4 3/8"



CUISINE 38000462 - SPF24
 Prato de Ovos 30
Egg Dish 30
Plato de Huevos 30
Plat Oeufs 30
 A 37 mm C 298 mm L 245 mm
 H 1 1/2" L 11 3/4" W 9 3/8"



CUISINE 38000467 - SPF21
 Prato de Ovos 26
Egg Dish 26
Plato de Huevos 26
Plat Oeufs 26
 A 35 mm C 255 mm L 210 mm
 H 1 3/8" L 10" W 8 1/4"



CUISINE 38000474 - SPF18
 Prato de Ovos 22
Egg Dish 22
Plato de Huevos 22
Plat Oeufs 22
 A 33 mm C 220 mm L 180 mm
 H 1 1/2" L 8 3/8" W 7"



CUISINE 38000484 - SPF15
 Prato de Ovos 18
Egg Dish 18
Plato de Huevos 18
Plat Oeufs 18
 A 28 mm C 180 mm L 151 mm
 H 1 1/8" L 7" W 6"



CUISINE 38001579 - SPF13
 Prato de Ovos 17
Egg Dish 17
Plato de Huevos 17
Plat Oeufs 17
 A 25 mm C 165 mm L 130 mm CAP. 175 ml
 H 1" L 6 1/2" W 5 1/8" CAP. 6 oz



CUISINE 38000685 - CS1
 Prato Meia Lua
Crescent Dish
Plato Media Luna
Assiette Demi-lune
 A 25 mm C 225 mm L 115 mm
 H 1" L 8 5/8" W 4 1/2"



CUISINE 38000690 - CD1
 Prato para Espiga
Corn Dish
Plato de Maíz
Assiette Épi de Maïs
 A 37 mm C 220 mm L 75 mm
 H 1 1/2" L 8 3/8" W 3"



CUISINE 38000441 - SPC12
 Prato Caracóis (12 unidades)
Snail Dish (12 units)
Plato de Caracoles (12 unidades)
Assiette Escargots (lot de 12)
 A 25 mm C 240 mm L 240 mm
 H 1" L 9 3/8" W 9 3/8"



CUISINE 38000280 - F8
 Tigela Sopa 15
Soup Bowl 15
Bowl 15
Bol à Soupe 15
 A 70 mm C 145 mm L 125 mm CAP. 450 ml
 H 2 3/4" L 5 5/8" W 5" CAP. 15 3/8 oz



CUISINE 38001573 - SPE56
 Tigela Sopa 11
Soup Bowl 11
Bowl 11
Bol à Soupe 11
 A 85 mm C 112 mm L 125 mm
 H 3 1/8" L 4 3/8" W 4 3/8"



LUNA



LUNA 38001359 - LUO48
 Assadeira Oval con Asas 48
 Oval Roaster with handles 48
 Fuente Horno Oval con Alas 48
 Plat à Four Ovale avec Poignées 48
 A 60 mm C 480 mm L 270 mm
 H 2 1/8" L 18 3/8" W 10 5/8"



LUNA 38001358 - LUO30
 Assadeira Oval con Asas 36
 Oval Roaster with handles 36
 Fuente Horno Oval con Alas 36
 Plat à Four Ovale avec Poignées 36
 A 60 mm C 360 mm L 200 mm
 H 2 1/8" L 14 1/8" W 7 7/8"



LUNA 38001357 - LUO24
 Assadeira Oval con Asas 25
 Oval Roaster with handles 25
 Fuente Horno Oval con Alas 25
 Plat à Four Ovale avec Poignées 25
 A 50 mm C 245 mm L 140 mm
 H 2" L 9 3/8" W 5 1/2"



LUNA 38001361 - LUO56
 Assadeira Oval con Asas 56
 Oval Roaster with handles 56
 Fuente Horno Oval con Alas 56
 Plat à Four Ovale avec Poignées 56
 A 55 mm C 560 mm L 185 mm
 H 2 1/8" L 22" W 7 3/8"



LUNA 38001360 - LUO35
 Assadeira Oval con Asas 41
 Oval Roaster with handles 41
 Fuente Horno Oval con Alas 41
 Plat à Four Ovale avec Poignées 41
 A 50 mm C 415 mm L 150 mm
 H 2" L 16 1/8" W 6"



LUNA 38001354 - LUS10
 Ramequim
 Ramekin
 Ramequin
 Ramequin
 A 55 mm C 105 mm L 105 mm CAP. 250 ml
 H 2 1/8" L 4 1/8" W 4 1/8" CAP. 8 3/4 oz



LUNA 38001365 - LUS27
 Saladeira 27
 Salad Bowl 27
 Ensaladera 27
 Saladier 27
 A 140 mm C 270 mm L 270 mm
 H 5 1/2" L 10 5/8" W 10 5/8"



LUNA 38001356 - LUS23
 Saladeira 23
 Salad Bowl 23
 Ensaladera 23
 Saladier 23
 A 120 mm C 230 mm L 230 mm
 H 4 3/8" L 9" W 9"



LUNA 38001364 - LUS18
 Saladeira 18
 Salad Bowl 18
 Ensaladera 18
 Saladier 18
 A 95 mm C 180 mm L 180 mm
 H 3 3/8" L 7" W 7"



LUNA 38001355 - LUS14
 Saladeira 14
 Salad Bowl 14
 Ensaladera 14
 Saladier 14
 A 75 mm C 140 mm L 140 mm
 H 3" L 5 1/2" W 5 1/2"



ORGANIC



ORGANIC 38001625 - ORO37
Assadeira Oval 37
Oval Roaster 37
Fuente Horno Oval 37
Plat à Four Ovale 37
A 67 mm C 370 mm L 260 mm
H 2 3/8" L 14 4/8" W 10 1/2"



ORGANIC 38001626 - ORO28
Assadeira Oval 28
Oval Roaster 28
Fuente Horno Oval 28
Plat à Four Ovale 28
A 67 mm C 280 mm L 190 mm CAP. 1176 ml
H 2 3/8" L 11" W 7 1/2" CAP. 39 3/4 oz



ORGANIC 38001630 - ORT29
Tarteira
Flan Dish
Tortera
Moule à Tarte
A 55 mm C 290 mm L 260 mm CAP. 1900 ml
H 2 1/8" L 11 3/8" W 10 1/4" CAP. 64 1/4 oz



ORGANIC 38001631 - ORS25
Soufflé
Soufflé
Soufflé
Soufflé
A 100 mm C 250 mm L 225 mm CAP. 2397 ml
H 4" L 9 3/8" W 8 5/8" CAP. 81 oz



ORGANIC 38001632 - ORS22
Prato de Ovos
Egg Dish
Plato de Huevos
Plat Oeufs
A 40 mm C 220 mm L 200 mm CAP. 634 ml
H 1 1/2" L 8 3/8" W 7 7/8" CAP. 21 1/4 oz



ORGANIC 38001633 - ORS15
Tigela
Bowl
Bowl
Coupe
A 78 mm C 150 mm L 140 mm CAP. 599 ml
H 3" L 6" W 5 1/2" CAP. 20 1/4 oz



ORGANIC 38001634 - ORS11
Ramequim (set de 2)
Set 2 x Ramekins
Ramequin (pack de 2)
Ramequin (lot de 2)
A 57 mm C 110 mm L 100 mm CAP. 220 ml
H 2 1/4" L 4 1/2" W 4" CAP. 7 1/4 oz



ORGANIC 38001627 - ORR37
Assadeira Rectangular 37
Rectangular Roaster 37
Fuente Horno Rectangular 37
Plat à Four Rectangulaire 37
A 70 mm C 360 mm L 280 mm CAP. 3650 ml
H 2 3/4" L 14 1/8" W 11" CAP. 123 3/7 oz



ORGANIC 38001628 - ORR31
Assadeira Rectangular 31
Rectangular Roaster 31
Fuente Horno Rectangular 31
Plat à Four Rectangulaire 31
A 60 mm C 310 mm L 230 mm CAP. 2100 ml
H 2 1/2" L 12 1/2" W 9" CAP. 71 oz



ORGANIC 38001629 - ORQ29
Assadeira Quadrada 29
Square Roaster 29
Fuente Horno Cuadrada 29
Plat à Four Carré 29
A 60 mm C 290 mm L 290 mm CAP. 2900 ml
H 2 1/2" L 11 3/8" W 11 3/8" CAP. 98 oz



CLASSIC



CLASSIC 37000605 - OBO
Assadeira Oval Grande 40
Large oval Roaster 40
Fuente Horno Oval Grande 40
Plat à Four Ovale Grand Modèle 40
A 70 mm C 400 mm L 270 mm
H 2 3/4" L 15 3/4" W 10 5/8"



CLASSIC 37000107 - FO
Assadeira Oval 39
Oval Roaster 39
Fuente Horno Oval 39
Plat à Four Ovale 39
A 65 mm C 390 mm L 255 mm
H 2 5/8" L 15 1/2" W 10"



CLASSIC 37000109 - F1
Assadeira Oval 35,5
Oval Roaster 35,5
Fuente Horno Oval 35,5
Plat à Four Ovale 35,5
A 60 mm C 355 mm L 245 mm CAP. 2725 ml
H 2 1/2" L 14" W 9 3/8" CAP. 92 1/2 oz



CLASSIC 37000110 - F3
Assadeira Oval 31,5
Oval Roaster 31,5
Fuente Horno Oval 31,5
Plat à Four Ovale 31,5
A 55 mm C 315 mm
L 210 mm CAP. 1875 ml
H 2 1/8" L 12 3/8" W 8 1/4" CAP. 63 3/8 oz



CLASSIC 37000112 - F2
Assadeira Oval 28
Oval Roaster 28
Fuente Horno Oval 28
Plat à Four Ovale 28
A 55 mm C 280 mm
L 185 mm CAP. 1525 ml
H 2 1/8" L 11" W 7 7/8" CAP. 51 4/8 oz



CLASSIC 37000114 - F4
Assadeira Oval 24
Oval Roaster 24
Fuente Horno Oval 24
Plat à Four Ovale 24
A 55 mm C 240 mm
L 165 mm CAP. 1100 ml
H 2 1/8" L 9 4/8" W 6 1/2" CAP. 37 1/2 oz



CLASSIC 37000073 - B22
Assadeira Quadrada 23
Square Roaster 23
Fuente Horno Cuadrada 23
Plat à Four Carré 23
A 60 mm C 230 mm
L 230 mm CAP. 1820 ml
H 2 1/2" L 9" W 9" CAP. 61 1/2 oz



CLASSIC 37000616 - OB7B
Assadeira Rectangular 42
Rectangular Roaster 42
Fuente Horno Rectangular 42
Plat à Four Rectangulaire 42
A 80 mm C 420 mm
L 240 mm CAP. 4740 ml
H 3 1/2" L 16 1/2" W 9 3/8" CAP. 160 3/8 oz



CLASSIC 37000116 - F7B
Assadeira Rectangular 33,5
Rectangular Roaster 33,5
Fuente Horno Rectangular 33,5
Plat à Four Rectangulaire 33,5
A 70 mm C 335 mm
L 255 mm CAP. 4000 ml
H 2 3/4" L 13 1/8" W 10" CAP. 135 1/4 oz



CLASSIC 37000118 - F7
Assadeira Rectangular 31
Rectangular Roaster 31
Fuente Horno Rectangular 31
Plat à Four Rectangulaire 31
A 65 mm C 310 mm
L 250 mm CAP. 2975 ml
H 2 3/8" L 12 1/8" W 9 3/8" CAP. 100 3/8 oz



CLASSIC 37000120 - F7A
Assadeira Rectangular 26,5
Rectangular Roaster 26,5
Fuente Horno Rectangular 26,5
Plat à Four Rectangulaire 26,5
A 50 mm C 265 mm
L 200 mm CAP. 1735 ml
H 2" L 10 3/8" W 7 7/8" CAP. 58 3/8 oz



CLASSIC 37000122 - F7C
Assadeira Rectangular 22,5
Rectangular Roaster 22,5
Fuente Horno Rectangular 22,5
Plat à Four Rectangulaire 22,5
A 50 mm C 225 mm
L 180 mm CAP. 1310 ml
H 2" L 8 3/8" W 7" CAP. 44 3/8 oz



CLASSIC 37000233 - L12
Tarteira 28,5
Flan Dish 28,5
Tortera 28,5
Moule à Tarte 28,5
A 50 mm C 285 mm
L 285 mm CAP. 2550 ml
H 2" L 11 3/8" W 11 3/8" CAP. 69 1/2 oz



CLASSIC 37000254 - L11
Tarteira 26
Flan Dish 26
Tortera 26
Moule à Tarte 26
A 45 mm C 260 mm
L 260 mm CAP. 1630 ml
H 1 7/8" L 10 1/4" W 10 1/4" CAP. 55 1/2 oz



CLASSIC 37002046 - L16
Tarteira 21,5
Flan Dish 21,5
Tortera 21,5
Moule à Tarte 21,5
A 35 mm C 215 mm L 215 mm
H 1 3/8" L 8 1/2" W 8 1/2"



CLASSIC 37000152 - F14
Tarteira 12,5
Flan Dish 12,5
Tortera 12,5
Moule à Tarte 12,5
A 30 mm C 125 mm
L 125 mm CAP. 220 ml
H 1 1/8" L 5" W 5" CAP. 7 1/2 oz



CLASSIC 37001038 - F6
Caçarola Oval 26
Oval casserole 26
Cacerola Oval 26
Cocotte Ovale 26
A 100 mm C 260 mm
L 165 mm CAP. 1470 ml
H 4" L 10 1/4" W 6 1/2" CAP. 49 5/7 oz



CLASSIC 37001871 - F17A
Caçarola Redonda 25
Round casserole 25
Cacerola Redonda 25
Cocotte Ronde 25
A 110 mm C 250 mm
L 250 mm CAP. 2760 ml
H 4 1/8" L 9 7/8" W 9 5/8" CAP. 93 1/3 oz



CLASSIC 37000878 - F17
Caçarola Redonda 20,5
Round casserole 20,5
Cacerola 20,5
Cocotte Ronde 20,5
A 100 mm C 205 mm
L 205 mm CAP. 1525 ml
H 4" L 8" W 8" CAP. 51 4/7 oz



CLASSIC 37000142 - F10B
Soufflé 23
Soufflé 23
Soufflé 23
Soufflé 23
A 95 mm C 230 mm
L 230 mm CAP. 2800 ml
H 3 3/4" L 9" W 9" CAP. 94 2/3 oz



CLASSIC 37000145 - F10
Soufflé 20
Soufflé 20
Soufflé 20
Soufflé 20
A 95 mm C 200 mm
L 200 mm CAP. 2150 ml
H 3 3/4" L 7 7/8" W 7 7/8" CAP. 72 3/7 oz



CLASSIC 37000150 - F10A
Soufflé 15,5
Soufflé 15,5
Soufflé 15,5
Soufflé 15,5
A 80 mm C 155 mm
L 155 mm CAP. 1055 ml
H 3 1/2" L 6 1/8" W 6 1/8" CAP. 35 2/3 oz



CLASSIC 37000187 - F8A
Tigela Sopa 16
Soup Bowl 16
Bowl 16
Bol à Soupe 16
A 75 mm C 160 mm
L 145 mm CAP. 640 ml
H 3" L 6 2/7" W 5 5/8" CAP. 21 2/3 oz



CLASSIC 37000174 - F8
Tigela Sopa 14,5
Soup Bowl 14,5
Bowl 14,5
Bol à Soupe 14,5
A 70 mm C 145 mm
L 125 mm CAP. 450 ml
H 2 3/4" L 5 5/8" W 5" CAP. 15 2/6 oz



CLASSIC 37000125 - F23C
Prato para Gratinados 32
Augratin 32
Plato Gratinados 32
Plat à Gratin 32
A 45 mm C 320 mm L 165 mm CAP. 900 ml
H 1 7/8" L 12 3/8" W 6 1/2" CAP. 30 3/4 oz



CLASSIC 37001594 - F23B
Prato para Gratinados 28
Augratin 28
Plato Gratinados 28
Plat à Gratin 28
A 40 mm C 280 mm L 155 mm CAP. 630 ml
H 1 1/2" L 11" W 6 1/8" CAP. 21 1/2 oz



CLASSIC 37000139 - F23
Prato para Gratinados 22
Augratin 22
Plato Gratinados 22
Plat à Gratin 22
A 30 mm C 220 mm L 120 mm CAP. 270 ml
H 1 1/8" L 8 2/3" W 4 3/4" CAP. 9 1/8 oz



CLASSIC 37001950 - SPF18
Prato de Ovos 22
Egg Dish 22
Plato de Huevos 22
Plat Oeufs 22
A 35 mm C 220 mm L 180 mm
H 1 3/8" L 8 2/3" W 7"



CLASSIC 37001951 - SPF15
Prato de Ovos 18,5
Egg Dish 18,5
Plato de Huevos 18,5
Plat Oeufs 18,5
A 30 mm C 185 mm L 160 mm
H 1 1/8" L 7 2/4" W 6 2/4"



CLASSIC 37001808 - SPF13
Prato de Ovos 16
Egg Dish 16
Plato de Huevos 16
Plat Oeufs 16
A 22 mm C 160 mm L 130 mm CAP. 175 ml
H 9/8" L 6 2/4" W 5 1/8" CAP. 6 oz



CLASSIC 37000155 - F9A
Ramequin 10,5
Ramekin 10,5
Ramequin 10,5
Ramequin 10,5
A 50 mm C 105 mm L 105 mm CAP. 280 ml
H 2" L 4 1/4" W 4 1/4" CAP. 9 1/2 oz



CLASSIC 37000163 - F9
Ramequin 9
Ramekin 9
Ramequin 9
Ramequin 9
A 50 mm C 90 mm L 90 mm
H 2" L 3 1/2" W 3 1/2"



CLASSIC 37002435 - SPS8
Ramequin 8
Ramekin 8
Ramequin 8
Ramequin 8
A 37 mm C 80 mm L 80 mm CAP. 120 ml
H 1 1/2" L 3 1/4" W 3 1/4" CAP. 4 oz



CLASSIC 37002436 - SPS6
Ramequin 6,3
Ramekin 6,3
Ramequin 6,3
Ramequin 6,3
A 30 mm C 63 mm L 63 mm CAP. 65 ml
H 1 1/8" L 2 1/2" W 2 1/2" CAP. 2 1/3 oz



CLASSIC 37001048 - F13A
Concha 16
Shell Dish 16
Vieira 16
Coquille 16
A 45 mm C 160 mm L 160 mm CAP. 380 ml
H 1 7/8" L 6 2/4" W 6 2/4" CAP. 12 7/8 oz



CLASSIC 37001049 - F13
Concha 14
Shell Dish 14
Vieira 14
Coquille 14
A 30 mm C 140 mm L 140 mm CAP. 150 ml
H 1 1/8" L 5 1/2" W 5 1/2" CAP. 5oz



CLASSIC 37000007 - 016
Assadeira Rectangular 19,5
Rectangular Roaster 19,5
Fuente Horno Rectangular 19,5
Plat à Four Rectangulaire 19,5
A 50 mm C 195 mm L 110 mm
H 2" L 7 2/3" W 4 1/3"



FESTIVAL



FESTIVAL 27020620
Caçarola Redonda Cinza 13
Round Casserole Grey 13
Cacerola Redonda Gris 13
Cocotte Ronde Gris 13
△ 300 gr A 60 mm C 130 mm L 110 mm CAP. 290 ml
△ 2/3 lbs H 2 3/8" L 5 1/8" W 4 1/8" CAP. 9 4/8 oz



FESTIVAL 27020621
Caçarola Redonda Vermelho 13
Round Casserole Red 13
Cacerola Redonda Rojo 13
Cocotte Ronde Rouge 13
△ 300 gr A 60 mm C 130 mm L 110 mm CAP. 290 ml
△ 2/3 lbs H 2 3/8" L 5 1/8" W 4 1/8" CAP. 9 4/8 oz



FESTIVAL 27020622
Caçarola Redonda Branco 19
Round Casserole White 19
Cacerola Redonda Blanco 19
Cocotte Ronde Blanc 19
△ 740 gr A 70 mm C 190 mm L 160 mm CAP. 750 ml
△ 1 3/8 lbs H 2 3/4" L 7 1/2" W 6 3/4" CAP. 25 3/8 oz



FESTIVAL 27020623
Caçarola Redonda Cinza 19
Round Casserole Grey 19
Cacerola Redonda Gris 19
Cocotte Ronde Gris 19
△ 740 gr A 70 mm C 190 mm L 160 mm CAP. 750 ml
△ 1 3/8 lbs H 2 3/4" L 7 1/2" W 6 3/4" CAP. 25 3/8 oz



FESTIVAL 27020624
Caçarola Redonda Vermelho 19
Round Casserole Red 19
Cacerola Redonda Rojo 19
Cocotte Ronde Rouge 19
△ 740 gr A 70 mm C 190 mm L 160 mm CAP. 750 ml
△ 1 3/8 lbs H 2 3/4" L 7 1/2" W 6 3/4" CAP. 25 3/8 oz



FIORENZA



FIORENZA 37004596
Assadeira Rectangular 39
Rectangular Roaster 39
Fuente Horno Rectangular 39
Plat à Four Rectangulaire 39
△ 3380 gr A 87 mm C 385 mm L 291 mm
△ 7 7/8" H 3 3/8" L 15 1/2" W 11 1/2"



FIORENZA 37004601
Tarteira 29
Tart Dish 29
Tortera 29
Moule à Tarte 29
△ 2200 gr A 50 mm C 290 mm
△ 4 9/16" H 2" L 11 3/8"



FIORENZA 37004599
Ramequin 9
Ramekin 9
Ramequin 9
Ramequin 9
△ 351 gr A 65 mm C 90 mm
△ 3 7/8" H 2 5/8" L 3 1/2"



FIORENZA 37004600
Forma Pudim 26
Bundt Pan 26
Moule à Gateau/Flan 26
Molde Bizcocho/ Pudim 26
△ 2500 gr A 123 mm C 261 mm
△ 5 1/2" H 4 9/16" L 10 3/8"



FIORENZA 37004597
Assadeira Quadrada 30
Square Roaster 30
Fuente Horno Cuadrada 30
Plat à Four Carré 30
△ 2681 gr A 86 mm C 299 mm
△ 6" H 3 3/8" W 11 7/8"



FIORENZA 37004598
Assadeira oval 34
Oval Roaster 34
Fuente Horno Oval 34
Plat à Four Ovale 34
△ 2042 gr A 84 mm C 340 mm L 230 mm
△ 4 1/2" H 2 5/8" L 13 3/8" W 9"



FUSION



FUSION 37000839 - FUO35
Assadeira Oval 36
Oval Roaster 36
Fuente Horno Oval 36
Plat à Four Ovale 36
A 70 mm C 360 mm L 250 mm
H 2 3/4" L 14 1/8" W 9 5/8"



FUSION 37000843 - FUO28
Assadeira Oval 29
Oval Roaster 29
Fuente Horno Oval 29
Plat à Four Ovale 29
A 60 mm C 290 mm L 200 mm
H 2 1/8" L 11 3/8" W 7 7/8"



FUSION 37001933 - FUO20
Assadeira Oval 20
Oval Roaster 20
Fuente Horno Oval 20
Plat à Four Ovale 20
A 45 mm C 200 mm L 140 mm
H 1 7/8" L 7 7/8" W 5 1/2"



FUSION 37000847 - FUR37
Assadeira Rectangular 37
Rectangular Roaster 37
Fuente Horno Rectangular 37
Plat à Four Rectangulaire 37
A 70 mm C 370 mm L 290 mm
H 2 3/4" L 14 3/4" W 11 3/8"



FUSION 37000851 - FUR32
Assadeira Rectangular 32
Rectangular Roaster 32
Fuente Horno Rectangular 32
Plat à Four Rectangulaire 32
A 60 mm C 320 mm L 250 mm
H 2 1/8" L 12 3/8" W 9 5/8"



FUSION 37001934 - FUR28
Assadeira Rectangular 28
Rectangular Roaster 28
Fuente Horno Rectangular 28
Plat à Four Rectangulaire 28
A 60 mm C 280 mm L 215 mm
H 2 1/8" L 11" W 8 1/2"



FUSION 37001935 - FUR20
Assadeira Rectangular 20
Rectangular Roaster 20
Fuente Horno Rectangular 20
Plat à Four Rectangulaire 20
A 45 mm C 200 mm L 155 mm
H 1 7/8" L 7 7/8" W 6 1/8"



FUSION 37000855 - FUQ30
Assadeira Quadrada 30
Square Roaster 30
Fuente Horno Cuadrada 30
Plat à Four Carré 30
A 70 mm C 300 mm L 270 mm
H 2 3/4" L 11 4/8" W 10 5/8"



FUSION 37001936 - FUQ28
Assadeira Quadrada 28
Square Roaster 28
Fuente Horno Cuadrada 28
Plat à Four Carré 28
A 65 mm C 280 mm L 250 mm
H 2 5/8" L 11" W 9 5/8"



FUSION 37001937 - FUQ20
Assadeira Quadrada 20
Square Roaster 20
Fuente Horno Cuadrada 20
Plat à Four Carré 20
A 45 mm C 200 mm L 175 mm
H 1 7/8" L 7 7/8" W 6 5/8"



FUSION 37001165 - FUC24
Caçarola Redonda con Tampa 24
Round Casserole with lid 24
Cacerola Redonda con Tapa 24
Cocotte Ronde avec Couverture 24
A 135 mm C 240 mm L 220 mm
H 5 1/8" L 9 4/8" W 8 7/8"



FUSION 37001181 - FUS24
Soufflé 24
Soufflé 24
Soufflé 24
Soufflé 24
A 100 mm C 240 mm L 220 mm
H 4" L 9 5/8" W 8 7/8"



FUSION 37000859 - FUS30
Tarteira 30
Flan dish 30
Tortera 30
Moule à Tarte 30
A 55 mm C 300 mm L 280 mm
H 2 1/8" L 11 4/8" W 11"



FUSION 37001064 - FUS20
Prato de Ovos 20
Egg dish 20
Plato de Huevos 20
Plat Oeufs 20
A 38 mm C 205 mm L 190 mm
H 1 1/2" L 8" W 7 1/2"



FUSION 37000935 - FUS11
Ramequin 11 (set de 2)
Ramekin 11 (pack of 2)
Ramequin 11 (pack de 2)
Ramequin (lot de 2)
A 55 mm C 110 mm L 105 mm
H 2 1/8" L 4 1/8" W 4 1/2"



FUSION 37002447 - FUS15
Taça Sobremesa Creme Brullee 15
Creme Brullee 15
Taza Crema de Leche 15
Assiette Dessert Crème Brûlée 15
A 25 mm C 150 mm L 140 mm
H 9 5/8" L 6" W 5 1/2"



FUSION 37001040 - 2PS
Gift Box Set: Assadeira Oval 28 + Assadeira Rectangular 32
Gift Box Set: Oval Roaster 28 + Rectangular Roaster 32
Pack Gift: Fuente Horno Oval 28 + Fuente Horno Rectangular 32
Coffret Cadeau: Plat à Four Ovale 28 + Plat à Four Rectangulaire 32
A 60 mm C 290 mm L 200 mm
H 2 1/8" L 11 3/8" W 7 7/8"



TRUE SCALE



TRUE SCALE 37004605
 Caçarola com Tampa 23
 Casserole 23
 Cacerola 23
 Cocotte 23
 △ 1622 gr A 130 mm C 236 mm L 188 mm
 △ 3 1/4" H 5 1/8" L 9 3/4" W 7 3/8"



TRUE SCALE 37004603
 Assadeira Oval 37
 Oval Roaster 37
 Fuente Horno Oval 37
 Plat à Four Ovale 37
 △ 1850 gr A 64 mm C 366 mm L 226 mm
 △ 4" H 2 3/4" L 14 3/8" W 8 9/8"



TRUE SCALE 37004602
 Assadeira Rectangular 42
 Rectangular Roaster 42
 Fuente Horno Rectangular 42
 Plat à Four Rectangulaire 42
 △ 2773 gr A 69 mm C 423 mm L 261 mm
 △ 6 1/8" H 2 3/4" L 16 3/8" W 10 2/8"



TRUE SCALE 37004604
 Assadeira Quadrada 25
 Square Roaster 25
 Fuente Horno Cuadrada 25
 Plat à Four Carré 25
 △ 1050 gr A 54 mm C 254 mm L 195 mm
 △ 2 1/8" H 2 1/8" L 10" W 7 3/8"



VIDRO





AROMA



AROMA 49000029
Pack com 4 Cálices Reserva
Set 4 Wine Tasting Stems
Pack com 4 Copas Reserva
Lot 4 Verres à Pied Vin Réserve
A 239 mm C 113 mm CAP. 760 ml
H 9 3/8" L 4 1/8" CAP. 25 3/8 oz



AROMA 49000031
Pack com 4 Cálices de Vinho Tinto
Set 4 Red Wine Goblets
Pack com 4 Copas de Vinho Tinto
Lot 4 Verres à Pied Vin Rouge
A 234 mm C 96 mm CAP. 580 ml
H 9 1/8" L 3 7/8" CAP. 19 3/8 oz



AROMA 49000032
Pack com 4 Cálices de Água
Set 4 Water Goblets
Pack com 4 Copas de Agua
Lot 4 Verres à Pied Eau
A 219 mm C 113 mm CAP. 675 ml
H 8 3/8" L 4 1/8" CAP. 22 3/8 oz



AROMA 49000034
Pack com 4 Cálices de Vinho Branco
Set 4 White Wine Goblets
Pack com 4 Copas de Vinho Branco
Lot 4 Verres à Pied Vin Blanc
A 220 mm C 82 mm CAP. 370 ml
H 8 3/8" L 3 3/8" CAP. 12 1/2 oz



AROMA 49000198
Pack com 4 Flutes
Set 4 Flutes
Pack com 4 Copas Flauta
Lot 4 Flûtes
A 239 mm C 67 mm CAP. 180 ml
H 9 3/8" L 2 7/8" CAP. 6 oz



AROMA 49000197
Pack com 4 Copos Baixos
Set with 4 Old Fashion
Pack com 4 Vasos Bajos
Lot 4 Chopes Basses
A 120 mm C 97 mm
H 4 3/8" L 3 3/8"



AROMA 49000042
Decantador
Decanter
Decantador
Carafe à Décanter
A 265 mm C 165 mm CAP. 1850 ml
H 10 3/8" L 6 1/2" CAP. 62 5/8 oz





BICOS



BICOS 49000009
 Pack 4 Copos Baixos
 Set 4 Old Fashion
 Pack con 4 Vasos Bajos
 Pack de 4 Gobelets
 A 107 mm C 86 mm CAP. 280 ml
 H 4 3/8" L 3 3/8" CAP. 9 1/2 oz



BICOS 49000012
 Pack 4 Copos Baixos Vermelho
 Set 4 Old Fashion Red
 Pack con 4 Vasos Bajos Rojo
 Pack de 4 Gobelets Rouge
 A 107 mm C 86 mm CAP. 280 ml
 H 4 3/8" L 3 3/8" CAP. 9 1/2 oz



BICOS 49000010
 Pack 4 Copos Baixos Âmbar
 Set 4 Old Fashion Ambar
 Pack con 4 Vasos Bajos Âmbar
 Pack de 4 Gobelets Ambre
 A 107 mm C 86 mm CAP. 280 ml
 H 4 3/8" L 3 3/8" CAP. 9 1/2 oz



BICOS 49000015
 Pack 4 Copos Baixos Azul
 Set 4 Old Fashion Blue
 Pack con 4 Vasos Bajos Azul
 Pack de 4 Gobelets Bleu
 A 107 mm C 86 mm CAP. 280 ml
 H 4 3/8" L 3 3/8" CAP. 9 1/2 oz



BICOS 49000014
 Pack 4 Copos Baixos Verde Menta
 Set 4 Old Fashion Mint Green
 Pack con 4 Vasos Bajos Verde Menta
 Pack de 4 Gobelets Vert Menthe
 A 107 mm C 86 mm CAP. 280 ml
 H 4 3/8" L 3 3/8" CAP. 9 1/2 oz



BICOS 49000016
 Pack 4 Copos Baixos Cinza
 Set 4 Old Fashion Gray
 Pack con 4 Vasos Bajos Gris
 Pack de 4 Gobelets Gris
 A 107 mm C 86 mm CAP. 280 ml
 H 4 3/8" L 3 3/8" CAP. 9 1/2 oz



BICOS 49001548
 Pack 4 Copos Baixos Verde Menta
 Set with 4 Old Fashion Pink
 Pack 4 Vasos Bajos Rosa
 Pack 4 Gobelets Rose
 A 107 mm C 86 mm CAP. 280 ml
 H 4 3/8" L 3 3/8" CAP. 9 1/2 oz



BICOS 49001557
 Pack 4 Copos Baixos Cinza
 Set with 4 Old Fashion Brown
 Pack 4 Vasos Bajos Rosa Marrón
 Pack 4 Gobelets Marron
 A 107 mm C 86 mm CAP. 280 ml
 H 4 3/8" L 3 3/8" CAP. 9 1/2 oz



BICOS 49000001
 Pack 4 Copos Altos
 Set 4 Highballs
 Pack 4 Vasos Altos
 Pack de 4 Chopes
 A 139 mm C 75 mm CAP. 330 ml
 H 5 1/2" L 3" CAP. 11 1/2 oz



BICOS 49000004
 Pack 4 Copos Altos Vermelho
 Set 4 Highballs Red
 Pack 4 Vasos Altos Rojo
 Pack de 4 Chopes Rouge
 A 139 mm C 75 mm CAP. 330 ml
 H 5 1/2" L 3" CAP. 11 1/2 oz



BICOS 49000002
 Pack 4 Copos Altos Âmbar
 Set 4 Highballs Ambar
 Pack 4 Vasos Altos Âmbar
 Pack de 4 Chopes Ambre
 A 139 mm C 75 mm CAP. 330 ml
 H 5 1/2" L 3" CAP. 11 1/2 oz



BICOS 49000007
 Pack 4 Copos Altos Azul
 Set 4 Highballs Blue
 Pack 4 Vasos Altos Azul
 Pack de 4 Chopes Bleu
 A 139 mm C 75 mm CAP. 330 ml
 H 5 1/2" L 3" CAP. 11 1/2 oz



BICOS 49000006
 Pack 4 Copos Altos Verde Menta
 Set 4 Highballs Mint Green
 Pack 4 Vasos Altos Verde Menta
 Pack de 4 Chopes Menthe
 A 139 mm C 75 mm CAP. 330 ml
 H 5 1/2" L 3" CAP. 11 1/8 oz



BICOS 49000008
 Pack 4 Copos Altos Cinza
 Set 4 Highballs Grey
 Pack 4 Vasos Altos Gris
 Pack de 4 Chopes Gris
 A 139 mm C 75 mm CAP. 330 ml
 H 5 1/2" L 3" CAP. 11 1/8 oz



BICOS 49001547
 Pack 4 Copos Altos Verde Menta
 Set with 4 Highballs Pink
 Pack 4 Vasos Altos Rosa
 Pack 4 Chopes Rose
 A 139 mm C 75 mm CAP. 330 ml
 H 5 1/2" L 3" CAP. 11 1/8 oz



BICOS 49001556
 Pack 4 Copos Altos Cinza
 Set with 4 Highballs Brown
 Pack 4 Vasos Altos Marrón
 Pack 4 Chopes Marron
 A 139 mm C 75 mm CAP. 330 ml
 H 5 1/2" L 3" CAP. 11 1/8 oz



BICOS 49000000
 Pack 4 Cálices de Água
 Set 4 Water Goblets
 Pack 4 Copas de Agua
 Pack de 4 Verres à Pied Eau
 A 170 mm C 88 mm CAP. 280 ml
 H 6 5/8" L 3 3/8" CAP. 9 3/8 oz



BICOS 49000057
 Pack 4 Cálices de Água Vermelho
 Set 4 Water Goblets Red
 Pack 4 Copas de Agua Rojo
 Pack de 4 Verres à Pied Eau Rouge
 A 170 mm C 88 mm CAP. 280 ml
 H 6 5/8" L 3 3/8" CAP. 9 3/8 oz



BICOS 49000055
 Pack 4 Cálices de Água Âmbar
 Set 4 Water Goblets Ambar
 Pack 4 Copas de Agua Ambar
 Pack de 4 Verres à Pied Eau Ambre
 A 170 mm C 88 mm CAP. 280 ml
 H 6 5/8" L 3 3/8" CAP. 9 3/8 oz



BICOS 49000060
 Pack 4 Cálices de Água Azul
 Set 4 Water Goblets Blue
 Pack 4 Copas de Agua Azul
 Pack de 4 Verres à Pied Eau Bleu
 A 170 mm C 88 mm CAP. 280 ml
 H 6 5/8" L 3 3/8" CAP. 9 3/8 oz



BICOS 49000059
 Pack 4 Cálices de Água Verde Menta
 Set 4 Water Goblets Mint Green
 Pack 4 Copas de Agua Verde Menta
 Pack de 4 Verres à Pied Eau Vert Menthe
 A 170 mm C 88 mm CAP. 280 ml
 H 6 5/8" L 3 3/8" CAP. 9 3/8 oz



BICOS 49000061
 Pack 4 Cálices de Água Cinza
 Set 4 Water Goblets Grey
 Pack 4 Copas de Agua Gris
 Pack de 4 Verres à Pied Eau Gris
 A 170 mm C 88 mm CAP. 280 ml
 H 6 5/8" L 3 3/8" CAP. 9 3/8 oz



BICOS 49001540
 Pack com 4 Cálices de Água Rosa
 Set with 4 Water Goblets Pink
 Pack con 4 Copas de Agua Rosa
 Pack 4 Verres à Pied Rose
 A 170 mm C 88 mm CAP. 280 ml
 H 6 5/8" L 3 3/8" CAP. 9 3/8 oz



BICOS 49001549
 Pack com 4 Cálices de Água Castanho
 Set with 4 Water Goblets Brown
 Pack con 4 Copas de Agua Marrón
 Pack 4 Verres à Pied Marron
 A 170 mm C 88 mm CAP. 280 ml
 H 6 5/8" L 3 3/8" CAP. 9 3/8 oz



BICOS BICOLOR



BICOS BICOLOR 49000427
Cálice com Pé Ambar
Goblet with Amber Stem
Copa con Pie Ambar
Verre à Pied Ambre
A 170 mm C 88 mm CAP. 280 ml
H 6 5/8" L 3 3/8" CAP. 9 1/2 oz



BICOS BICOLOR 49000428
Cálice com Pé Cinza
Goblet with Grey Stem
Copa con Pie Gris
Verre à Pied Gris
A 170 mm C 88 mm CAP. 280 ml
H 6 5/8" L 3 3/8" CAP. 9 1/2 oz



BICOS BICOLOR 49000429
Cálice com Pé Verde Menta
Goblet with Green Stem
Copa con Pie Verde
Verre à Pied Vert
A 170 mm C 88 mm CAP. 280 ml
H 6 5/8" L 3 3/8" CAP. 9 1/2 oz



BICOS BICOLOR 49000430
Cálice com Pé Vermelho
Goblet with Red Stem
Copa con Pie Rojo
Verre à Pied Rouge
A 170 mm C 88 mm CAP. 280 ml
H 6 5/8" L 3 3/8" CAP. 9 1/2 oz



BICOS BICOLOR 49000431
Cálice com Bojo Ambar
Goblet with Amber Top
Copa con Top Ambar
Verre avec Tasse Ambre
A 170 mm C 88 mm CAP. 280 ml
H 6 5/8" L 3 3/8" CAP. 9 1/2 oz



BICOS BICOLOR 49000432
Cálice com Bojo Cinza
Goblet with Grey Top
Copa con Top Gris
Verre avec Tasse Gris
A 170 mm C 88 mm CAP. 280 ml
H 6 5/8" L 3 3/8" CAP. 9 1/2 oz



BICOS BICOLOR 49000433
Cálice com Bojo Verde Menta
Goblet with Green Top
Copa con Top Verde
Verre avec Tasse Vert
A 170 mm C 88 mm CAP. 280 ml
H 6 5/8" L 3 3/8" CAP. 9 1/2 oz



BICOS BICOLOR 49000434
Cálice com Bojo Vermelho
Goblet with Red Top
Copa con Top Rojo
Verre avec Tasse Rouge
A 170 mm C 88 mm CAP. 280 ml
H 6 5/8" L 3 3/8" CAP. 9 1/2 oz



BICOS BICOLOR 49000436
Cálice Branco Mate/ Brilho
Frosted Goblet Matt/ Gloss
Copa Blanco Mate/ Brillo
Verre Blanc Mate/ Brillant
A 170 mm C 88 mm CAP. 280 ml
H 6 5/8" L 3 3/8" CAP. 9 1/2 oz



BICOS BICOLOR 49000437
Cálice Preto Mate/ Brilho
Black Goblet Matt/ Gloss
Copa Negra Mate/ Brillo
Verre Noir Mate/ Brillant
A 170 mm C 88 mm CAP. 280 ml
H 6 5/8" L 3 3/8" CAP. 9 1/2 oz



CAMPANIA



CAMPANIA ACA21/003161400006
 Copo Baixo Incolor
Old Fashion Clear
 Vaso Bajo Incoloro
Chope Basse Incolore
 A 109 mm CAP. 335 ml
 H 4 3/4" CAP. 11 1/3 oz



CAMPANIA ACA10/003161300006
 Cálice Incolor
Goblet Clear
 Copa Incoloro
Verre à Pied Incolore
 A 148 mm CAP. 305 ml
 H 5 5/8" CAP. 10 1/3 oz



CAMPANIA ACA31/003161500001
 Jarro Incolor
Pitcher Clear
 Jarra Incoloro
Pichet Incolore
 A 182 mm Ø 135 mm CAP. 1000 ml
 H 7 1/8" Ø 5 1/8" CAP. 33 1/2 oz



CAMPANIA ACA21/003161473006
 Copo Baixo Verde Menta
Old Fashion Mint
 Vaso Bajo Verde Menta
Chope Basse Vert Menthe
 A 109 mm CAP. 335 ml
 H 4 3/4" CAP. 11 1/3 oz



CAMPANIA ACA10/003161373006
 Cálice Verde Menta
Goblet Mint
 Copa Verde Menta
Verre à Pied Vert Menthe
 A 148 mm CAP. 305 ml
 H 5 5/8" CAP. 10 1/3 oz



CAMPANIA ACA31/003161573001
 Jarro Verde Menta
Pitcher Mint
 Jarra Verde Mente
Pichet vert Menthe
 A 182 mm Ø 135 mm CAP. 1000 ml
 H 7 1/8" Ø 5 1/8" CAP. 33 1/2 oz



CAMPANIA ACA21/003161492006
 Copo Baixo Cinza
Old Fashion Grey
 Vaso Bajo Gris
Chope Basse Gris
 A 109 mm CAP. 335 ml
 H 4 3/4" CAP. 11 1/3 oz



CAMPANIA ACA10/003161392006
 Cálice Cinza
Goblet Grey
 Copa Gris
Verre à Pied Gris
 A 148 mm CAP. 305 ml
 H 5 5/8" CAP. 10 1/3 oz



DUNES



DUNES 49000523
Copo Alto Incolor
Large Tumbler Clear
Vaso Alto Incolor
Verre Forme Haute Incolore
A 153 mm Ø 96 mm CAP. 491 ml
H 6" Ø 3 7/8" CAP. 16 3/8 oz



DUNES 49000524
Copo Alto Cinza 92
Large Tumbler Grey 92
Vaso Alto Gris 92
Verre Forme Haute Gris 92
A 153 mm Ø 96 mm CAP. 491 ml
H 6" Ø 3 7/8" CAP. 16 3/8 oz



DUNES 49000525
Copo Alto Verde Menta 73
Large Tumbler Mint Green 73
Vaso Alto Verde Menta 73
Verre Forme Haute Vert 73
A 153 mm Ø 96 mm CAP. 491 ml
H 6" Ø 3 7/8" CAP. 16 3/8 oz



NATURE



NATURE 49000512
Copo Baixo Incolor
Small Tumbler Clear
Vaso Bajo Incolor
Chope Basse Incolore
A 98 mm Ø 95 mm
H 3 5/8" Ø 3 3/4"



NATURE 49000511
Copo Baixo Ambar 26
Small Tumbler Ambar 26
Vaso Bajo Ambar 26
Chope Basse Ambre 26
A 98 mm Ø 95 mm
H 3 5/8" Ø 3 3/4"



NATURE 49000700
Copo Baixo Cinza 92
Small Tumbler Grey 92
Vaso Bajo Gris 92
Chope Basse Gris 92
A 98 mm Ø 95 mm
H 3 5/8" Ø 3 3/4"



NATURE 49000701
Copo Baixo Verde 61
Small Tumbler Green 61
Vaso Bajo Verde 61
Chope Basse Vert 61
A 98 mm Ø 95 mm
H 3 5/8" Ø 3 3/4"



ORGANICO



ORGANICO 49000513
Copo Alto Incolor
Large Tumbler Clear
Vaso Alto Incolor
Verre Forme Haute Incolore
A 130 mm Ø 87 mm
H 5 1/8" Ø 3 3/4"



ORGANICO 49000514
Copo Alto Verde 63
Large Tumbler Green 63
Vaso Alto Verde 63
Verre Forme Haute Vert 63
A 130 mm Ø 87 mm
H 5 1/8" Ø 3 3/4"



ORGANICO 49000515
Copo Alto Azul 80
Large Tumbler Blue 80
Vaso Alto Azul 80
Verre Forme Haute Bleu 80
A 130 mm Ø 87 mm
H 5 1/8" Ø 3 3/4"



ORGANICO 49000516
Copo Baixo Incolor
Small Tumbler Clear
Vaso Baixo Incolor
Chope Basse Incolore
A 120 mm Ø 79 mm
H 4 3/4" Ø 3 1/8"



ORGANICO 49000517
Copo Baixo Verde 63
Small Tumbler Green 63
Vaso Baixo Verde 63
Chope Basse Vert 63
A 120 mm Ø 79 mm
H 4 3/4" Ø 3 1/8"



ORGANICO 49000518
Copo Baixo Azul 80
Small Tumbler Blue 80
Vaso Baixo Azul 80
Chope Basse Bleu 80
A 120 mm Ø 79 mm
H 4 3/4" Ø 3 1/8"



DECORATIVO



STARS by Martina Süsse

Concebida pela jovem designer Martina Süsse, no âmbito do projeto ID Pool da Vista Alegre, a linha *Stars* é marcada por um espírito lúdico que não esconde a complexidade do seu desenho e da sua conceção. Seis peças muito contemporâneas, que se complementam e adequam a qualquer contexto e ambiente: vaso, solitário, cinzeiro de água, açucareiro de pacotes, tealight e argola de guardanapo. Mais uma proposta inovadora gerada no ID Pool.

Conceived by young designer Martina Süsse under Vista Alegre's ID Pool project, the Stars line is marked by a playful spirit that does not hide the complexity of its design and conception. Six very contemporary pieces that complement each other and suit any context and environment: vase, solitary flower holder, water ashtray, sugar packet dispenser, tealight and napkin ring. Another innovative proposal generated in the ID Pool.

Creada por la joven diseñadora Martina Süsse, en el ámbito del proyecto ID Pool de Vista Alegre, la línea Stars se caracteriza por un espíritu lúdico que no esconde la complejidad de su diseño y de su concepción. Seis piezas muy contemporáneas, que se complementan y adecúan a cualquier contexto y ambiente: jarrón, solitario, cenicero de agua, azucarero de azucarillos, tealight y anillo de servilleta. Otra propuesta innovadora creada en el ID Pool.

Conçue par la jeune designer Martina Süsse, dans le cadre du projet ID Pool de Vista Alegre, la ligne Stars est marquée par un esprit ludique qui ne cache pas la complexité de sa conception et design. Six pièces très contemporaines qui se complètent et conviennent à tout contexte et environnement : vase, soliflore, cendrier à eau, sucrier pour sachets de sucre, photophore et rond de serviette. Une autre proposition novatrice, générée dans le cadre d'ID Pool.





STARS 21117340
 Cinzeiro Água
 Water Ashtray
 Cenicero Agua
 Cendrier à Eau
 △ 248 gr A 54 mm Ø 110 mm
 △ 5/8 lbs H 2 1/8" Ø 4 1/2"



STARS 21117341
 Tealight
 Tealight
 Portavelas
 Photophore
 △ 146 gr A 74 mm C 89 mm L 54 mm
 △ 1/3 lbs H 3" L 3 1/2" W 2 1/8"



STARS 21117342
 Vaso Flores
 Flower Vase
 Florero
 Vase à Fleurs
 △ 207 gr A 100 mm C 104 mm L 95 mm
 △ 1/2 bs H 4" L 4" W 3 3/4"



STARS 21117343
 Solitário
 Bud Vase
 Solitario
 Soliflore
 △ 275 gr A 124 mm Ø 95 mm
 △ 3/8 lbs H 4 7/8" Ø 3 3/4"



STARS 21117344
 Açucareiro Pacotes
 Sugarbowl
 Azucarero Paquetes
 Saucier Sachets de Sucre
 △ 274 gr A 112 mm C 115 mm L 105 mm
 △ 3/8 bs H 4 3/8" L 4 1/2" W 4 1/2"



STARS 21117345
 Argola Guardanapos
 Napkin Ring
 Anilla Servilletas
 Rond de Serviette
 △ 53 gr A 43 mm Ø 54 mm
 △ 1/8 bs H 1 2/3" Ø 2 1/8"

PORCELANA DECORATIVA

PORCELAIN GIFT | PORCELANA DECORATIVA | PORCELAIN DÉCORATION





QUARTZ 21104237
 Jarra Grande
Large Vase
Florero Grande
Vase Grand Modèle
 △ 2530 gr A 304 mm Ø 299 mm
 △ 5 1/2 lbs H 12" Ø 11 7/8"



QUARTZ 21104236
 Jarra Alta
Tall Vase
Florero Alto
Vase Haute
 △ 3140 gr A 374 mm Ø 240 mm
 △ 7 lbs H 14 5/8" Ø 9 1/2"



QUARTZ 21104238
 Jarra Pequena
Small Vase
Florero Pequeño
Vase Petit Modèle
 △ 1690 gr A 247 mm Ø 250 mm
 △ 3 7/8 lbs H 9 5/8" Ø 9 9/16"



QUARTZ 21105899
 Centro Mesa
Centrepiece
Centro Mesa
Centre de Table
 △ 1330 gr A 95 mm Ø 394 mm
 △ 3 lbs H 3 3/4" Ø 5 1/2"



MATRIX 21108629
 Jarra Alta Estreita
Tall Thin Vase
Florero Alto Estrecho
Vase Haut Étroit
 △ 1320 gr A 263 mm C 192 mm L 71 mm
 △ 3 lbs H 10 1/2" 7 3/8" W 2 7/8"



MATRIX 21108630
 Jarra Alta Larga
Tall Large Vase
Florero Grande Alto
Vase Haut Large
 △ 1320 gr A 261 mm C 198 mm L 73 mm
 △ 3 lbs H 10 3/8" L 7 4/8" W 2 7/8"



MATRIX 21108631
 Bandeja
Tray
Bandeja
Plateau
 △ 710 gr A 43 mm C 294 mm L 197 mm
 △ 1 1/2 lbs H 1 3/8" L 11 1/8" W 7 3/8"



MATRIX 21108632
 Jarra Larga
Large Vase
Florero Grande
Vase Large
 △ 1740 gr A 195 mm C 264 mm L 107 mm
 △ 3 3/8 lbs H 7 3/8" L 10 3/8" W 4 1/8"

CUTELARY | CUBIERTOS | COUVERTS



CUTELARIA





DOMO





DOMO 27014916
Garfo de Mesa
Table Fork
Tenedor de Mesa
Fourchette de Table
C 213 mm
L 8 3/8"



DOMO 27014915
Faca de Mesa
Table Knife
Cuchillo Mesa
Couteau de Table
C 231 mm
L 9"



DOMO 27014922
Garfo de Peixe
Fish Fork
Tenedor Pescado
Fourchette à Poisson
C 200 mm
L 7 7/8"



DOMO 27014921
Faca de Peixe
Fish Knife
Pala Pescado
Couteau à Poisson
C 210 mm
L 8 1/4"



DOMO 27014917
Colher de Sopa
Soup Spoon
Cuchara Mesa
Cuillère à Soupe
C 201 mm
L 8"



DOMO 27014919
Garfo de Sobremesa
Dessert Fork
Tenedor de Postre
Fourchette à Dessert
C 193 mm
L 7 3/8"



DOMO 27014918
Faca de Sobremesa
Dessert Knife
Cuchillo de Postre
Couteau à Dessert
C 216 mm
L 8 1/2"



DOMO 27014920
Colher de Sobremesa
Dessert Spoon
Cuchara de Postre
Cuillère à Dessert
C 184 mm
L 7 1/4"



DOMO 27014923
Colher de Chá
Tea Spoon
Cuchara de Tê
Cuillère à Thé
C 136 mm
L 5 3/8"



DOMO 27014924
Colher de Café
Coffee Spoon
Cuchara de Café
Cuillère à Café
C 102 mm
L 4"



DOMO 27014929
Pá Bolo
Cake Server
Pala Tarta
Pelle à Tarte
C 248 mm
L 9 3/4"



DOMO 27014925
Concha Terrina
Soup Ladle
Cazo Sopa
Louche
C 288 mm
L 11 1/8"



DOMO 27014926
Colher de Servir
Serving Spoon
Cucharon de Servir
Cuillère de Service
C 264 mm
L 10 3/8"



DOMO 27014930
Colher de Molho
Sauce Ladle
Cazo de Salsa
Cuillère à Sauce
C 206 mm
L 8 1/8"



DOMO 27014933
Colher de Açúcar
Sugar Spoon
Cuchara de Azucar
Cuillère à Sucre
C 143 mm
L 5 5/8"



DOMO 27014928
Garfo de Servir Carne
Meat Serving Fork
Tenedor de Servir Carne
Fourchette de Service Viande
C 271 mm
L 10 3/4"



DOMO 27014927
Faca de Servir Carne
Meat Serving Knife
Cuchillo de Servir Carne
Couteau de Service Viande
C 288 mm
L 11 1/8"



DOMO 27014931
Talheres Salada (2P)
Salad Server (2P)
Cubierto de Ensalada (2P)
Couverts Salade (2P)
C 255 mm
L 10"



DOMO 27014932
Faca de Queijo
Cheese Knife
Cuchillo de Queso
Couteau à Fromage
C 234 mm
L 9 1/8"



DOMO 27017207
Colher Sopa Oval
Oval Soup Spoon
Cuchara Mesa Oval
Cuillère à Soupe Ovale
C 201 mm
L 8"



DOMO MATT





DOMO MATT 27020808
Faca de Mesa
Table Knife
Cuchillo Mesa
Couteau de Table
C 231 mm
L 9 1/8"



DOMO MATT 27020809
Garfo De Mesa
Table Fork
Tenedor Mesa
Fourchette de Table
C 213 mm
L 8 3/8"

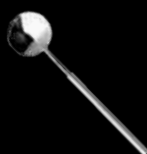

DOMO MATT 27020810
Colher de Sopa
Soup Spoon
Cuchara Mesa
Cuillère à Soupe
C 201 mm
L 7 9/8"



DOMO MATT 27020811
Faca De Sobremesa
Dessert Knife
Cuchillo Postre
Couteau à Dessert
C 216 mm
L 8 1/2"



DOMO MATT 27020812
Garfo De Sobremesa
Dessert Fork
Tenedor de Postre
Fourchette à Dessert
C 193 mm
L 7 3/8"



DOMO MATT 27020813
Colher De Sobremesa
Dessert Spoon
Cuchara Postre
Cuillère à Dessert
C 184 mm
L 7 1/4"



DOMO MATT 27020814
Faca De Peixe
Fish Knife
Pala Pescado
Couteau à Poisson
C 210 mm
L 8 1/4"



DOMO MATT 27020815
Garfo De Peixe
Fish Fork
Tenedor Pescado
Fourchette à Poisson
C 200 mm
L 7 7/8"

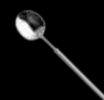

DOMO MATT 27020816
Colher Chá
Tea Spoon
Cuchara de Tê
Cuillère à Tê
C 136 mm
L 5 3/8"



DOMO MATT 27020817
Colher Café
Coffee Spoon
Cuchara de Moka
Cuillère à Café
C 102 mm
L 4"



DOMO MATT 27020818
Concha Terrina
Soup Ladle
Cazo Sopa
Louche
C 288 mm
L 11 1/8"



DOMO MATT 27020819
Colher Servir
Serving Spoon
Cucharon de Servir
Cuillère de Service
C 264 mm
L 10 3/8"



DOMO MATT 27020820
Faca Servir Carne
Meat Serving Knife
Cuchillo Servir carne
Couteau de Service Viande
C 288 mm
L 11 1/8"



DOMO MATT 27020821
Garfo De Servir Carne
Meat Serving Fork
Tenedor Servir Carne
Fourchette de Service Viande
C 271 mm
L 10 3/8"



DOMO MATT 27020822
Pá Bolo
Cake Server
Pala Tarta
Pelle à Tarte
C 248 mm
L 9 3/4"



DOMO MATT 27020823
Colher Molho
Sauce Ladle
Cazo de Salsa
Cuillère à Sauce
C 206 mm
L 8 1/8"



DOMO MATT 27020824
Talheres Salada (2P)
Salad Server (2P)
Cubierto de Ensalada (2P)
Couverts Salade
C 255 mm
L 10"



DOMO MATT 27020825
Faca Queijo
Cheese Knife
Cuchillo Queso
Couteau à Fromage
C 234 mm
L 9 3/8"



DOMO MATT 27020826
Colher Açucar
Sugar Spoon
Cuchara de Azucar
Cuillère à Sucre
C 143 mm
L 5 3/8"



DOMO HANDLE MATT GOLD





DOMO HANDLE MATT GOLD
27020858
Faca de Mesa
Table Knife
Cuchillo Mesa
Couteau de Table
C 231 mm
L 9 1/4"



DOMO HANDLE MATT GOLD
27020859
Garfo De Mesa
Table Fork
Tenedor Mesa
Fourchette de Table
C 213 mm
L 8 3/4"



DOMO HANDLE MATT GOLD
27020860
Colher de Sopa
Soup Spoon
Cuchara Mesa
Cuillère à Soupe
C 201 mm
L 7 7/8"



DOMO HANDLE MATT GOLD
27020861
Faca De Sobremesa
Dessert Knife
Cuchillo Postre
Couteau à Dessert
C 216 mm
L 8 1/2"



DOMO HANDLE MATT GOLD
27020862
Garfo De Sobremesa
Dessert Fork
Tenedor de Postre
Fourchette à Dessert
C 193 mm
L 7 3/4"



DOMO HANDLE MATT GOLD
27020863
Colher De Sobremesa
Dessert Spoon
Cuchara Postre
Cuillère à Dessert
C 184 mm
L 7 1/4"



DOMO HANDLE MATT GOLD
27020864
Faca De Peixe
Fish Knife
Pala Pescado
Couteau à Poisson
C 210 mm
L 8 1/4"



DOMO HANDLE MATT GOLD
27020865
Garfo De Peixe
Fish Fork
Tenedor Pescado
Fourchette à Poisson
C 200 mm
L 7 7/8"

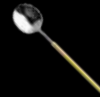

DOMO HANDLE MATT GOLD
27020866
Colher Chá
Tea Spoon
Cuchara de Tê
Cuillère à Tê
C 136 mm
L 5 3/8"



DOMO HANDLE MATT GOLD
27020867
Colher Café
Coffee Spoon
Cuchara de Moka
Cuillère à Café
C 102 mm
L 4"



DOMO HANDLE MATT GOLD
27020868
Concha Terrina
Soup Ladle
Cazo Sopa
Louche
C 288 mm
L 11 1/2"



DOMO HANDLE MATT GOLD
27020869
Colher Servir
Serving Spoon
Cucharon de Servir
Cuillère de Service
C 264 mm
L 10 3/5"



DOMO HANDLE MATT GOLD
27020870
Faca Servir Carne
Meat Serving Knife
Cuchillo Servir carne
Couteau de Service Viande
C 288 mm
L 11 1/2"



DOMO HANDLE MATT GOLD
27020871
Garfo De Servir Carne
Meat Serving Fork
Tenedor Servir Carne
Fourchette de Service Viande
C 271 mm
L 10 3/5"



DOMO HANDLE MATT GOLD
27020872
Pá Bolo
Cake Server
Pala Tarta
Pelle à Tarte
C 248 mm
L 9 3/4"



DOMO HANDLE MATT GOLD
27020873
Colher Molho
Sauce Ladle
Cazo de Salsa
Cuillère à Sauce
C 206 mm
L 8 1/4"



DOMO HANDLE MATT GOLD
27020874
Talheres Salada (2P)
Salad Server (2P)
Cubierto de Ensalada (2P)
Couverts Salade
C 255 mm
L 10"



DOMO HANDLE MATT GOLD
27020875
Faca Queijo
Cheese Knife
Cuchillo Queso
Couteau à Fromage
C 234 mm
L 9 3/8"



DOMO HANDLE MATT GOLD
27020876
Colher Açucar
Sugar Spoon
Cuchara de Azucar
Cuillère à Sucre
C 143 mm
L 5 3/8"



ELEGANCE



ELEGANCE 27007654
Garfo de Mesa
Table Fork
Tenedor de Mesa
Fourchette de Table
C 215 mm
L 8 1/2"

ELEGANCE 27007653
Faca de Mesa
Table Knife
Cuchillo Mesa
Couteau de Table
C 230 mm
L 9"

ELEGANCE 27007655
Colher de Sopa
Soup Spoon
Cuchara Mesa
Cuillère à Soupe
C 209 mm
L 8 2/9"



ELEGANCE 27007660
Garfo de Peixe
Fish Fork
Tenedor Pescado
Fourchette à Poisson
C 215 mm
L 8 1/2"



ELEGANCE 27007659
Faca de Peixe
Fish Knife
Pala Pescado
Couteau à Poisson
C 213 mm
L 8 3/8"



ELEGANCE 27007657
Garfo de Sobremesa
Dessert Fork
Tenedor de Postre
Fourchette à Dessert
C 180 mm
L 7"



ELEGANCE 27007656
Faca de Sobremesa
Dessert Knife
Cuchillo de Postre
Couteau à Dessert
C 204 mm
L 8"



ELEGANCE 27007658
Colher de Sobremesa
Dessert Spoon
Cuchara de Postre
Cuillère à Dessert
C 183 mm
L 7 1/8"



ELEGANCE 27007661
Colher de Chá
Tea Spoon
Cuchara de Tê
Cuillère à Thé
C 148 mm
L 5 3/8"



ELEGANCE 27008003
Colher de Café
Coffee Spoon
Cuchara de Café
Cuillère à Café
C 123 mm
L 4 3/8"



ELEGANCE 27007666
Pã Bolo
Cake Server
Pala Tarta
Pelle à Tarte
C 263 mm
L 10 1/8"



ELEGANCE 27007662
Concha Terrina
Soup Ladle
Cazo Sopa
Louche
C 300 mm
L 11 3/8"



ELEGANCE 27007663
Colher de Servir
Serving Spoon
Cucharon de Servir
Cuillère de Service
C 254 mm
L 10"



ELEGANCE 27007667
Colher de Molho
Sauce Ladle
Cazo de Salsa
Cuillère à Sauce
C 202 mm
L 8"



ELEGANCE 27008354
Colher de Açúcar
Sugar Spoon
Cuchara de Azucar
Cuillère à Sucre
C 116 mm
L 4 1/2"



ELEGANCE 27008346
Garfo de Servir Carne
Meat Serving Fork
Tenedor de Servir Carne
Fouchette de Service Viande
C 255 mm
L 10"



ELEGANCE 27008345
Faca de Servir Carne
Meat Serving Knife
Cuchillo de Servir Carne
Couteau de Service Viande
C 247 mm
L 9 5/8"



ELEGANCE 27007665
Garfo de Servir Peixe
Fish Serving Fork
Tenedor de Servir Pescado
Fourchette de Service Poisson
C 254 mm
L 10"



ELEGANCE 27007664
Faca de Servir Peixe
Fish Serving Knife
Cuchillo de Servir Pescado
Couteau de Service Poisson
C 247 mm
L 9 5/8"



ELEGANCE 27008351
Talheres Salada (2P)
Salad Server (2P)
Cubierto de Ensalada (2P)
Couverts Salade (2P)
C 210 mm
L 8 1/4"



ELEGANCE 27018685
Espátula Manteiga
Butter Knife
Pala de Mantequilla
Couteau à Beurre
C 156 mm
L 6 1/4"



LINEA





LINEA 27007606
Garfo de Mesa
Table Fork
Tenedor de Mesa
Fourchette de Table
C 202 mm
L 8"



LINEA 27007605
Faca de Mesa
Table Knife
Cuchillo Mesa
Couteau de Table
C 238 mm
L 9 3/8"



LINEA 27007612
Garfo de Peixe
Fish Fork
Tenedor Pescado
Fourchette à Poisson
C 175 mm
L 6 8/8"



LINEA 27007611
Faca de Peixe
Fish Knife
Pala Pescado
Couteau à Poisson
C 197 mm
L 7 3/4"



LINEA 27007607
Colher de Sopa
Soup Spoon
Cuchara Mesa
Cuillère à Soupe
C 208 mm
L 8 1/5"



LINEA 27007609
Garfo de Sobremesa
Dessert Fork
Tenedor de Postre
Fourchette à Dessert
C 172 mm
L 6 7/8"



LINEA 27007608
Faca de Sobremesa
Dessert Knife
Cuchillo de Postre
Couteau à Dessert
C 200 mm
L 7 7/8"



LINEA 27007610
Colher de Sobremesa
Dessert Spoon
Cuchara de Postre
Cuillère à Dessert
C 173 mm
L 6 3/8"



LINEA 27007613
Colher de Chá
Tea Spoon
Cuchara de Té
Cuillère à Thé
C 133 mm
L 5 1/4"



LINEA 27007916
Colher de Café
Coffee Spoon
Cuchara de Café
Cuillère à Café
C 105 mm
L 4 1/4"



LINEA 27007618
Pá Bolo
Cake Server
Pala Tarta
Pelle à Tarte
C 246 mm
L 9 3/8"



LINEA 27007614
Concha Terrina
Soup Ladle
Cazo Sopa
Louche
C 295 mm
L 11 3/8"



LINEA 27007615
Colher de Servir
Serving Spoon
Cucharon de Servir
Cuillère de Service
C 234 mm
L 9 1/8"



LINEA 27007619
Colher de Molho
Sauce Ladle
Cazo de Salsa
Cuillère à Sauce
C 188 mm
L 7 3/8"



LINEA 27008355
Colher de Açúcar
Sugar Spoon
Cuchara de Azucar
Cuillère à Sucre
C 130 mm
L 5 1/8"



LINEA 27008348
Garfo de Servir Carne
Meat Serving Fork
Tenedor de Servir Carne
Fourchette de Service Viande
C 240 mm
L 9 3/8"



LINEA 27008347
Faca de Servir Carne
Meat Serving Knife
Cuchillo de Servir Carne
Couteau de Service Viande
C 245 mm
L 9 3/8"



LINEA 27007617
Garfo de Servir Peixe
Fish Serving Fork
Tenedor de Servir Pescado
Fourchette de Service Poisson
C 237 mm
L 9 1/8"



LINEA 27007616
Faca de Servir Peixe
Fish Serving Knife
Cuchillo de Servir Pescado
Couteau de Service Poisson
C 242 mm
L 9 1/2"



LINEA 27008352
Talheres Salada (2P)
Salad Server (2P)
Cubierto de Ensalada (2P)
Couverts Salade (2P)
C 200 mm
L 7 7/8"



PLAZZA





PLAZZA 27007862
Garfo de Mesa
Table Fork
Tenedor de Mesa
Fourchette de Table
C 207 mm
L 8 1/2"



PLAZZA 27007861
Faca de Mesa
Table Knife
Cuchillo Mesa
Couteau de table
C 230 mm
L 9"



PLAZZA 27007868
Garfo de Peixe
Fish Fork
Tenedor Pescado
Fourchette à Poisson
C 196 mm
L 7 5/8"



PLAZZA 27007867
Faca de Peixe
Fish Knife
Pala Pescado
Couteau à Poisson
C 218 mm
L 8 3/4"



PLAZZA 27007863
Colher de Sopa
Soup Spoon
Cuchara Mesa
Cuillère à Soupe
C 207 mm
L 8 1/2"



PLAZZA 27007865
Garfo de Sobremesa
Dessert Fork
Tenedor de Postre
Fourchette à Dessert
C 186 mm
L 7 1/8"



PLAZZA 27007864
Faca de Sobremesa
Dessert Knife
Cuchillo de Postre
Couteau à Dessert
C 205 mm
L 8"



PLAZZA 27007866
Colher de Sobremesa
Dessert Spoon
Cuchara de Postre
Cuillère à Dessert
C 186 mm
L 7 1/8"



PLAZZA 27007869
Colher de Chá
Tea Spoon
Cuchara de Té
Cuillère à Thé
C 141 mm
L 5 5/8"



PLAZZA 27007870
Colher de Café
Coffee Spoon
Cuchara de Café
Cuillère à Café
C 121 mm
L 4 3/4"



PLAZZA 27007876
Pá Bolo
Cake Server
Pala Tarta
Pelle à Tarte
C 248 mm
L 9 3/4"



PLAZZA 27007872
Concha Terrina
Soup Ladle
Cazo Sopa
Louche
C 290 mm
L 11 3/8"



PLAZZA 27007873
Colher de Servir
Serving Spoon
Cucharon de Servir
Cuillère de Service
C 257 mm
L 10 1/8"



PLAZZA 27007877
Colher de Molho
Sauce Ladle
Cazo de Salsa
Cuillère à Sauce
C 188 mm
L 7 3/8"



PLAZZA 27007871
Colher de Açúcar
Sugar Spoon
Cuchara de Azucar
Cuillère à Sucre
C 127 mm
L 5"



PLAZZA 27007875
Garfo de Servir Carne
Meat Serving Fork
Tenedor de Servir Carne
Fourchette de Service Viande
C 256 mm
L 10"



PLAZZA 27007874
Faca de Servir Carne
Meat Serving Knife
Cuchillo de Servir Carne
Couteau de Service Viande
C 276 mm
L 10 5/8"



PLAZZA 27007888
Garfo de Servir Peixe
Fish Serving Fork
Tenedor de Servir Pescado
Fourchette de Service Poisson
C 256 mm
L 10"



PLAZZA 27007887
Faca de Servir Peixe
Fish Serving Knife
Cuchillo de Servir Pescado
Couteau de Service Poisson
C 276 mm
L 10 5/8"



PLAZZA 27007878
Talheres Salada (2P)
Salad Server (2P)
Cubierto de Ensalada (2P)
Couverts Salade (2P)
C 245 mm
L 9 3/8"



PLAZZA 27007891
Garfo Churrasco
Steak Fork
Tenedor Chutelero
Fourchette Barbecue
C 210 mm
L 8 1/4"



PLAZZA 27007889
Faca Churrasco
Steak Knife
Cuchillo Chutelero
Couteau Barbecue
C 230 mm
L 9"



PLAZZA 27007879
Faca de Queijo
Cheese Knife
Cuchillo de Queso
Couteau à Fromage
C 233 mm
L 9 1/8"



PLAZZA 27007892
Espátula Manteiga
Butter Knife
Pala de Mantequilla
Couteau à Beurre
C 155 mm
L 6 1/8"



PLAZZA 27007894
Garfo Aperitivo
Aperitifs Fork
Tenedor Aperitivos
Fourchette Mise en Bouche
C 140 mm
L 5 1/2"



PRISM





PRISM 27021158
Faca De Mesa
Table Knife
Cuchillo Mesa
Couteau de Table
C 249 mm
L 9 7/8"



PRISM 27021159
Garfo De Mesa
Table Fork
Tenedor Mesa
Fourchette de Table
C 217 mm
L 8 1/2"



PRISM 27021160
Colher De Sopa
Soup Spoon
Cuchara Mesa
Cuillère à Soupe
C 217 mm
L 8 1/2"



PRISM 27021161
Faca De Sobremesa
Dessert Knife
Cuchillo Postre
Couteau à Dessert
C 217 mm
L 8 1/2"



PRISM 27021162
Garfo De Sobremesa
Dessert Fork
Tenedor de Postre
Fourchette à Dessert
C 195 mm
L 7 7/8"



PRISM 27021163
Colher De Sobremesa
Dessert Spoon
Cuchara Postre
Cuillère à Dessert
C 194 mm
L 7 7/8"



PRISM 27021164
Faca De Peixe
Fish Knife
Pala Pescado
Couteau à Poisson
C 219 mm
L 8 5/8"



PRISM 27021165
Garfo De Peixe
Fish Fork
Tenedor Pescado
Fourchette à Poisson
C 210 mm
L 8 1/4"



PRISM 27021166
Colher Chá
Tea Spoon
Cuchara de Té
Cuillère à Té
C 143 mm
L 5 5/8"



PRISM 27021167
Colher Café
Coffee Spoon
Cuchara de Moka
Cuillère à Café
C 123 mm
L 4 7/8"



PRISM 27021168
Concha Terrina
Soup Ladle
Cazo Sopa
Louche
C 339 mm
L 13 1/8"



PRISM 27021169
Colher Servir
Serving Spoon
Cucharon de Servir
Cuillère de Service
C 270 mm
L 10 5/8"



PRISM 27021170
Faca Servir Carne
Meat Serving Knife
Cuchillo Servir carne
Couteau de Service Viande
C 258 mm
L 10 1/4"



PRISM 27021171
Garfo De Servir Carne
Meat Serving Fork
Tenedor Servir Carne
Fourchette de Service Viande
C 277 mm
L 11"



PRISM 27021172
Pá Bolo
Cake Server
Pala Tarta
Pelle à Tarte
C 257 mm
L 10 5/8"



PRISM 27021173
Colher Molho
Sauce Ladle
Cazo de Salsa
Cuillère à Sauce
C 212 mm
L 8 1/8"



PRISM 27021174
Talheres Salada (2P)
Salad Server (2P)
Cubierto de Ensalada (2P)
Couverts Salade
C 255 mm
L 10"



PRISM 27021175
Faca Servir Peixe
Fish Serving Knife
Cuchillo Servir Pescado
Couteau de Service Poisson
C 260 mm
L 10 1/4"



PRISM 27021176
Colher Açucar
Sugar Spoon
Cuchara de Azucar
Cuillère à Sucre
C 139 mm
L 5 1/2"



SPA





SPA 27007622
Garfo de Mesa
Table Fork
Tenedor de Mesa
Fourchette de Table
C 205 mm
L 8"



SPA 27007621
Faca de Mesa
Table Knife
Cuchillo Mesa
Couteau de Table
C 230 mm
L 9"



SPA 27007628
Garfo de Peixe
Fish Fork
Tenedor Pescado
Fourchette à Poisson
C 193 mm
L 7 3/8"



SPA 27007627
Faca de Peixe
Fish Knife
Pala Pescado
Couteau à Poisson
C 215 mm
L 8 1/2"



SPA 27007623
Colher de Sopa
Soup Spoon
Cuchara Mesa
Cuillère à Soupe
C 211 mm
L 8 1/8"



SPA 27007625
Garfo de Sobremesa
Dessert Fork
Tenedor de Postre
Fourchette à Dessert
C 183 mm
L 7 1/8"



SPA 27007624
Faca de Sobremesa
Dessert Knife
Cuchillo de Postre
Couteau à Dessert
C 200 mm
L 7 7/8"



SPA 27007626
Colher de Sobremesa
Dessert Spoon
Cuchara de Postre
Cuillère à Dessert
C 186 mm
L 7 1/8"



SPA 27007629
Colher de Chá
Tea Spoon
Cuchara de Té
Cuillère à Thé
C 147 mm
L 5 9/8"



SPA 27007914
Colher de Café
Coffee Spoon
Cuchara de Café
Cuillère à Café
C 120 mm
L 4 5/8"



SPA 27007634
Pá Bolo
Cake Server
Pala Tarta
Pelle à Tarte
C 252 mm
L 10"



SPA 27007630
Concha Terrina
Soup Ladle
Cazo Sopa
Louche
C 295 mm
L 11 3/8"



SPA 27007631
Colher de Servir
Serving Spoon
Cucharon de Servir
Cuillère de Service
C 253 mm
L 10"



SPA 27007635
Colher de Molho
Sauce Ladle
Cazo de Salsa
Cuillère à Sauce
C 190 mm
L 7 1/2"



SPA 27008356
Colher de Açúcar
Sugar Spoon
Cuchara de Azucar
Cuillère à Sucre
C 130 mm
L 5 1/8"



SPA 27008350
Garfo de Servir Carne
Meat Serving Fork
Tenedor de Servir Carne
Fourchette de Service Viande
C 250 mm
L 9 3/8"



SPA 27008349
Faca de Servir Carne
Meat Serving Knife
Cuchillo de Servir Carne
Couteau de Service Viande
C 255 mm
L 10"



SPA 27007633
Garfo de Servir Peixe
Fish Serving Fork
Tenedor de Servir Pescado
Fourchette de Service Poisson
C 255 mm
L 10"



SPA 27007632
Faca de Servir Peixe
Fish Serving Knife
Cuchillo de Servir Pescado
Couteau de Service Poisson
C 255 mm
L 10"



SPA 27008353
Talheres Salada (2P)
Salad Server (2P)
Cubierto de Ensalada (2P)
Couverts Salada (2P)
C 250 mm
L 9 5/8"



SPA 27007915
Espátula Manteiga
Butter Knife
Pala de Mantequilla
Couteau à Beurre
C 145 mm
L 5 3/8"



VEGA





VEGA 27008394
Garfo de Mesa
Table Fork
Tenedor de Mesa
Fourchette de Table
C 208 mm
L 8 1/2"



VEGA 27008393
Faca de Mesa
Table Knife
Cuchillo Mesa
Couteau de Table
C 245 mm
L 9 2/3"



VEGA 27008400
Garfo de Peixe
Fish Fork
Tenedor Pescado
Fourchette à Poisson
C 180 mm
L 7"



VEGA 27008399
Faca de Peixe
Fish Knife
Pala Pescado
Couteau à Poisson
C 200 mm
L 7 1/2"



VEGA 27008395
Colher de Sopa
Soup Spoon
Cuchara Mesa
Cuillère à Soupe
C 205 mm
L 8"



VEGA 27008397
Garfo de Sobremesa
Dessert Fork
Tenedor de Postre
Fourchette à Dessert
C 177 mm
L 7"



VEGA 27008396
Faca de Sobremesa
Dessert Knife
Cuchillo de Postre
Couteau à Dessert
C 207 mm
L 8 1/4"



VEGA 27008398
Colher de Sobremesa
Dessert Spoon
Cuchara de Postre
Cuillère à Dessert
C 175 mm
L 6 5/8"



VEGA 27008401
Colher de Chá
Tea Spoon
Cuchara de Tê
Cuillère à Thé
C 137 mm
L 5 2/8"



VEGA 27008402
Colher de Café
Coffee Spoon
Cuchara de Café
Cuillère à Café
C 108 mm
L 4 1/4"



VEGA 27008406
Pá Bolo
Cake Server
Pala Tarta
Pelle à Tarte
C 243 mm
L 9 4/8"



VEGA 27008403
Concha Terrina
Soup Ladle
Cazo Sopa
Louche
C 285 mm
L 11 2/8"



VEGA 27008404
Colher de Servir
Serving Spoon
Cucharon de Servir
Cuillère de Service
C 253 mm
L 10"



VEGA 27008405
Colher de Molho
Sauce Ladle
Cazo de Salsa
Cuillère à Sauce
C 195 mm
L 7 2/8"



VEGA 27008411
Colher de Açúcar
Sugar Spoon
Cuchara de Azucar
Cuillère à Sucre
C 130 mm
L 5 1/8"



VEGA 27008408
Garfo de Servir Carne
Meat Serving Fork
Tenedor de Servir Carne
Fourchette de Service Viande
C 253 mm
L 10"



VEGA 27008407
Faca de Servir Carne
Meat Serving Knife
Cuchillo de Servir Carne
Coutaue De Service Viande
C 255 mm
L 10"



VEGA 27008409
Faca de Servir Peixe
Fish Serving Knife
Cuchillo de Servir Pescado
Coutau de Service Poisson
C 250 mm
L 9 5/8"



VEGA 27008410
Talheres Salada (2P)
Salad Server (2P)
Cubierto de Ensalada (2P)
Couverts Salade (2P)
C 245 mm
L 9 2/8"



VEGA 27016836
Espátula Manteiga
Butter Knife
Pala de Mantequilla
Couteau à Beurre
C 156 mm
L 6 1/8"



VELVET





VELVET 27008901
Garfo de Mesa
Table Fork
Tenedor de Mesa
Fourchette de Table
C 208 mm
L 8 1/2"



VELVET 27008900
Faca de Mesa
Table Knife
Cuchillo Mesa
Couteau de table
C 242 mm
L 9 1/2"



VELVET 27008907
Garfo de Peixe
Fish Fork
Tenedor Pescado
Fourchette à Poisson
C 208 mm
L 8 1/2"



VELVET 27008906
Faca de Peixe
Fish Knife
Pala Pescado
Couteau à Poisson
C 210 mm
L 8 1/4"



VELVET 27017208
Faca de Peixe
Fish Knife
Pala Pescado
Couteau à Poisson
C 209 mm
L 8 3/8"



VELVET 27008902
Colher de Sopa
Soup Spoon
Cuchara Mesa
Cuillère à Soupe
C 207 mm
L 8 1/2"



VELVET 27008904
Garfo de Sobremesa
Dessert Fork
Tenedor de Postre
Fourchette à Dessert
C 184 mm
L 7 1/4"



VELVET 27008903
Faca de Sobremesa
Dessert Knife
Cuchillo de Postre
Couteau à Dessert
C 218 mm
L 8 3/4"



VELVET 27008905
Colher de Sobremesa
Dessert Spoon
Cuchara de Postre
Cuillère à Dessert
C 184 mm
L 7 1/4"



VELVET 27008908
Colher de Chá
Tea Spoon
Cuchara de Té
Cuillère à Thé
C 141 mm
L 5 3/8"



VELVET 27008909
Colher de Café
Coffee Spoon
Cuchara de Café
Cuillère à Café
C 121 mm
L 4 3/4"



VELVET 27008915
Pã Bolo
Cake Server
Pala Tarta
Pelle à Tarte
C 245 mm
L 9 2/5"



VELVET 27008911
Concha Terrina
Soup Ladle
Cazo Sopa
Louche
C 284 mm
L 11 1/4"



VELVET 27008912
Colher de Servir
Serving Spoon
Cucharon de Servir
Cuillère de Service
C 259 mm
L 10 1/2"



VELVET 27008916
Colher de Molho
Sauce Ladle
Cazo de Salsa
Cuillère à Sauce
C 194 mm
L 7 2/5"



VELVET 27008910
Colher de Açúcar
Sugar Spoon
Cuchara de Azucar
Cuillère à Sucre
C 138 mm
L 5 3/8"



VELVET 27008914
Garfo de Servir Carne
Meat Serving Fork
Tenedor de Servir Carne
Fourchette de Service Viande
C 259 mm
L 10 1/2"



VELVET 27008913
Faca de Servir Carne
Meat Serving Knife
Cuchillo de Servir Carne
Couteau de Service Viande
C 267 mm
L 10 1/2"



VELVET 27008923
Garfo de Servir Peixe
Fish Serving Fork
Tenedor de Servir Pescado
Fourchette de Service Poisson
C 260 mm
L 10 1/4"



VELVET 27008922
Faca de Servir Peixe
Fish Serving Knife
Cuchillo de Servir Pescado
Couteau de Service Poisson
C 268 mm
L 10 5/8"



VELVET 27008917
Talheres Salada (2P)
Salad Server (2P)
Cubierto de Ensalada (2P)
Couverts Salade (2P)
C 205 mm
L 8"



VELVET 27008920
Faca Churrasco
Steak Knife
Cuchillo Chutelero
Couteau Barbecue
C 241 mm
L 9 1/2"



VELVET 27008918
Faca de Queijo
Cheese Knife
Cuchillo de Queso
Couteau à Fromage
C 242 mm
L 9 1/2"



VELVET 27008921
Espátula Manteiga
Butter Knife
Pala de Mantequilla
Couteau à Beurre
C 158 mm
L 6 3/8"



VELVET MATT





VELVET MATT 27020831
Faca de Mesa
Table Knife
Cuchillo Mesa
Couteau de Table
C 242 mm
L 9 1/2"



VELVET MATT 27020832
Garfo De Mesa
Table Fork
Tenedor Mesa
Fourchette de Table
C 208 mm
L 8 1/4"



VELVET MATT 27020833
Colher de Sopa
Soup Spoon
Cuchara Mesa
Cuillère à Soupe
C 207 mm
L 8 1/4"



VELVET MATT 27020834
Faca De Sobremesa
Dessert Knife
Cuchillo Postre
Couteau à Dessert
C 218 mm
L 8 3/4"



VELVET MATT 27020835
Garfo De Sobremesa
Dessert Fork
Tenedor de Postre
Fourchette à Dessert
C 184 mm
L 7 1/4"



VELVET MATT 27020836
Colher De Sobremesa
Dessert Spoon
Cuchara Postre
Cuillère à Dessert
C 184 mm
L 7 1/2"



VELVET MATT 27020837
Faca De Peixe
Fish Knife
Pala Pescado
Couteau à Poisson
C 210 mm
L 8 1/4"



VELVET MATT 27020838
Garfo De Peixe
Fish Fork
Tenedor Pescado
Fourchette à Poisson
C 208 mm
L 8 1/4"



VELVET MATT 27020839
Colher Chá
Tea Spoon
Cuchara de Tê
Cuillère à Tê
C 141 mm
L 5 3/4"



VELVET MATT 27020840
Colher Café
Coffee Spoon
Cuchara de Moka
Cuillère à Café
C 121 mm
L 4 3/4"



VELVET MATT 27020841
Concha Terrina
Soup Ladle
Cazo Sopa
Louche
C 284 mm
L 11 1/2"



VELVET MATT 27020842
Colher Servir
Serving Spoon
Cucharon de Servir
Cuillère de Service
C 259 mm
L 10 1/2"



VELVET MATT 27020843
Faca Servir Carne
Meat Serving Knife
Cuchillo Servir carne
Couteau de Service Viande
C 267 mm
L 10 1/2"



VELVET MATT 27020844
Garfo De Servir Carne
Meat Serving Fork
Tenedor Servir Carne
Fourchette de Service Viande
C 259 mm
L 10 3/4"



VELVET MATT 27020845
Faca Servir Peixe
Fish Serving Knife
Cuchillo Servir Pescado
Couteau de Service Poisson
C 268 mm
L 10 3/4"



VELVET MATT 27020846
Pá Bolo
Cake Server
Pala Tarta
Pelle à Tarte
C 245 mm
L 9 3/8"



VELVET MATT 27020847
Colher Molho
Sauce Ladle
Cazo de Salsa
Cuillère à Sauce
C 194 mm
L 7 3/8"



VELVET MATT 27020848
Talheres Salada (2P)
Salad Server (2P)
Cubierto de Ensalada (2P)
Couverts Salade
C 205 mm
L 8"



VELVET MATT 27020849
Colher Açúcar
Sugar Spoon
Cuchara de Azucar
Cuillère à Sucre
C 138 mm
L 5 3/8"

AGRADECIMENTOS

SPECIAL THANKS | AGRADecIMIENTOS | REMERCIEMENTS

A Vista Alegre agradece a amável cedência dos espaços às seguintes entidades:

Vista Alegre would like to thank the following restaurants for the use of their spaces:

Vista Alegre agradece amablemente a las siguientes entidades los espacios prestados:

Vista Alegre remercie les restaurants qui ont eu la gentillesse de prêter leurs espaces, à savoir:

1300 Taberna

O! Moon, Stars, Tecido & Optima
Chef Nuno Barros

À Justa

Exuberant & Noir
Chef Justa Nobre

Altis Avenida

Whisper, Tiles & Venezia Hotel
Chef João Correia

Big Fish Poke

Maré Alta
Chef Luis Gaspar

Bistro 100 Maneiras

Spirit Hotel
Chef Ljubomir Stanisic

Cantina da Estrela

Karma
Chef Susana Rainha

Darwin's Café

Marés
Chef António Runa

DOP

Silk Road
Chef Rui Paula

DUPLEX

Trace
Chef Nuno Bergonse

El Buló Social Club

Iris, Floral Scent & Sauvage
Chef Chakall

Eleven

Domo
Chef Joachim Koerper

Epic Sana

Gourmet
Chef Patrick Lefeuvre

Feitoria

Infinita & Theatre
Chef João Rodrigues

Fortaleza do Guincho

Perla
Chef Vincent Farges

Hotel DoubleTree Fontana Park by Hilton

Artville & Mar Hotel
Chef Paula Carção

JNcQuoi Asia

Asia
Chefs António Bóia @ Mário Esteves

Grupo Pestana Hotels & Resorts

Pestana Palace - Escorial
Chef Pedro Inglês Marques

Parador Casa da Ínsua

Estoril & Bragança
Chef Paulo Cardoso

Pousada de Cascais - Organic

Taberna da Praça - Carré
Chef Manuel Alexandre

Montebelo Agueira Lake Resort & Spa

Europa & Buffet
Chef Eva Correia

Montebelo Viseu Hotel & Spa

Coimbra, Algarve & Luna
Chef João Paulo Varela

Olivier Avenida

Infinita, Saturn & Texture
Chef Olivier da Costa

Origami

Tapas e Sushi
Chef Alan Lima

Pedro e o Lobo

Matrix
Chef Diogo Noronha

Pizzaria ZeroZero

Shine
Chef Libório Buonocore

Príncipe Perfeito Hotel

Sagres & Broadway
Chef Maria José Carvalho

Sala de Corte

Bronze & Utopia
Chef Luis Gaspar

Sana Myriad

Multiforma
Chef Frederic Breitenbucher

Sky Bar Tivoli Oriente

Cocktail White
& Transatlântica Hotel

Tasca da Esquina

Couvert
Chef Vitor Sobral

The Yeatman

Synergy
Chef Ricardo Costa

Troppo Squisito

Imperfect White
Chef Marcelo Santos

Zambeze Restaurante

Virtual
Chef João Paulo Varela

FICHA TÉCNICA | CREDITS | FICHA TÉCNICA | FICHE TECHNIQUE

Fotografia Photography Fotografia Photos

Nuno Correia | Fabrice Demoulin | Patrick Rougureau | Lionel Balteiro

100% Foto Mário Cerdeira

Chefs' Collection, Mineral, Silica & Temptation

Chef Vitor Matos

1300
Taberna
LX Factory



CANTINA
DA ESTRELA
RESTAURANTE DE BAIRRO

PARADORES
Casa da Ínsua



eleven
by ANTONIO KOPPEL

EPIC SANA
Lisboa



HOTEL
PRÍNCIPE
PERFEITO
VISEU

MONTEBELO
AGUIEIRA
LAKE RESORT & SPA

MONTEBELO
VISEU
HOTEL & SPA



origami



POUSADA
CASCAIS
Cidadela Historic Hotel

PESTANA
CIDADELA CASCAIS
POUSADA & ART DISTRICT
COLLECTION HOTELS
PORTUGAL



Rui Paula

THE
YEATMAN
OPORTO

ZamBeZe
restaurante
by Montebelo

100% FOTO
FOOD PHOTOGRAPHY

DUPLEX

Divier
AVENIDA

ALTIS AVENIDA
HOTEL

ORIENTE
SKY
BAR

AJUSTA
RESTAURANTE

DOUBLETREE
BY HILTON
LISBON - FONTANA PARK

ZeroZero
PIZZERIA



TROPPO
SQUISITO
RISTORANTE ITALIANO

BIG FISH
POKE

JNÊQUOI

ASIA

CONTACTOS

Contacts

VISTA ALEGRE

3830-292 Ílhavo
Portugal
Tel. +351 234 320 600
geral@vistaalegre.com
vistaalegre.com

HOTELWARE COMERCIAL HOTELWARE DEPARTMENT HOTELWARE SERVICE COMMERCIALE

Portugal
Tel. +351 707 246 835
hotelware@vistaalegre.com
hotelware.vistaalegre.com

MARKETING VISTA ALEGRE

Tel. +351 234 320 600
Fax. +351 234 320 793
marketing@vistaalegre.com

APOIO AO CLIENTE COSTUMER SERVICE APOYO AL CLIENTE SERVICE CLIENT

Tel. +351 707 266 822
Fax. +351 234 320 783
sac@vistaalegre.com
servicocliente@vistaalegre.com

VISTA ALEGRE FRANÇA

42 Boulevard du Temple
75011 Paris
Fones: +33 1 47 00 07 62
+33 7 84 34 73 23
france@vistaalegre.com

VISTA ALEGRE USA

Trade Showroom:
41 Madison Ave – 9th floor
New York, NY 10010
Toll free: (888) 653-0108
Direct Local: (917) 831-4377
Fax: (917) 831-4466
usa@vistaalegre.com

Warehouse:
Luxe-Ops Inc.
16 Chapin Road, Suite 908
Pine Brook, NJ 07058

VISTA ALEGRE ESPANHA

**DIREÇÃO COMERCIAL ESPANHA
SPAIN SALES DEPARTMENT
ESPAÑA DIRECCIÓN COMERCIAL
DIRECTION COMMERCIALE ESPAGNE**
Calle de Claudio Coello, 53
28001 Madrid
Tel. +34 914 026 722
Fax. +34 914 027 476
espana@vistaalegre.com

VISTA ALEGRE BRASIL

**DIREÇÃO COMERCIAL BRASIL
BRAZIL SALES DEPARTMENT
BRASIL DIRECCIÓN COMERCIAL
DIRECTION COMMERCIALE BRÉSIL**

São Paulo
Rua Bandeira Paulista, 726 - 6º andar
Itaim Bibi, São Paulo - SP
CEP: 04532-002
Fones +55 11 2679 4881
+55 11 3081-1921
brasil@vistaalegre.com

VISTA ALEGRE MÉXICO

Avenida Homero, 526
Piso 2 – Despacho 202
Colonia Polanco, Del. Miguel Hidalgo
C.P. 11550, Ciudad de México – México
Tel. +52 (55) 8663 0134
+52 (55) 8663 0151
mexico@vistaalegre.com

VISTA ALEGRE MOÇAMBIQUE

**DIREÇÃO COMERCIAL MOÇAMBIQUE
MOZAMBIQUE SALES DEPARTMENT
MOZAMBIQUE DIRECCIÓN COMERCIAL
DIRECTION COMMERCIALE MOZAMBIQUE**

Maputo
Av. Kenneth Kuanda
nº 403, R/C, Sommerchild - Maputo
Tel. +258 21 480 580
mocambique@vistaalegre.com

VISTA ALEGRE ÍNDIA

**DIREÇÃO COMERCIAL ÍNDIA
INDIA SALES DEPARTMENT
INDIA DIRECCIÓN COMERCIAL
DIRECTION COMMERCIALE INDE**

Nova Deli
C16 Pamposh Enclave
New Delhi 110048
Tel. +91-11-41014755
+91-11-49149855
sales@vistaalegre.in



hotelware.vistaalegre.com