



T W E N T Y

**CAL·MIL**

T W E N T Y





Monterey Collection, Pages 2 – 7



Empire Collection, Pages 8 – 11



Portland Collection, Pages 12 – 19

## CAL•MIL Collections

Monterey Collection	2 – 7
Empire Collection	8 – 11
Portland Collection	12 – 19
Granada Collection	20 – 25
Cinderwood Collection	26 – 33
Ashwood Collection	34 – 45
Madera Collection	46 – 63
Sierra Collection	64 – 73
Mid-Century Collection	74 – 81
Bamboo Collection	82 – 97
Eco Modern Collection	98 – 101
Midnight Collection	102 – 111
Westport Collection	112 – 115
Iron Collection	116 – 119
Mission Collection	120 – 125
Luxe Collection	126 – 131
Urban Collection	132 – 135
Squared Collection	136 - 139
Soho Collection	140 - 143
One By One Collection	144 - 149
Classic Collection	150 – 159



Madera Collection, Pages 46 – 63



## Product Categories

Accent Bowls & Displays	252 - 253
Bar & Mixology Displays	334 - 341
Beverage & Serving Carts	172 - 177
Beverage Dispensers	160 - 169
Bread Displays	273 - 278
Bulk Food Dispensers	186
Cal-Mil Cares	342 - 343
Case Displays	262 - 272
Cereal Dispensers	178 - 185
Chafers & Alternatives	206 - 215
Chalkboard Displays	331 - 333
Click Condiment Dispensers	188
Cold Concept Systems	192 - 193
Condiment & Packet Displays	294 - 307
Covers & Trays	202 - 205
Cup & Lid Organizers	316 - 321
Cutting Boards & Carving	293
Flatware & Condiment Displays	308 - 313
Flatware Displays	314
Ice Housings & Ice Carvings	222 - 231
Ice Scoops & Holders	232 - 233
Melamine Displays	194 - 198
Melamine Plates and Bowls	199 - 201
Merchandising Displays	257 - 261
Mirror & Serving Stones	290 - 292

Napkin Organizers	315
Pitchers & Drip Trays	170 - 171
Porcelain Displays	189 - 190
Porcelain Plates and Bowls	191
Powder & Tea Dispensers	187
Replacement Parts	344
Riser Displays	234 - 251
Room Service & Amenities	254 - 256
Salad Displays & Sneezeguards	216 - 221
Signage Displays	322 - 329
Straw & Toothpick Organizers	286
Tabletop & Serving Boards	279 - 285
Write On Displays	330
Yogurt & Ice Cream	287 - 289





# MONTEREY collection



A



B



C



D

A. MONTEREY  
**BEVERAGE DISPENSER NEW**  
 3 Gallon Capacity.  
 Includes Chamber and Drip Tray.  
 ITEM 22117-3-15 | 8½Wx10Dx25½H | Ice  
 ITEM 22117-3INF-15 | 8½Wx10Dx25½H | Infusion

B. MONTEREY  
**CEREAL DISPENSER NEW**  
 Features Pull & Serve Mechanism.  
 600 Cubic Inch Capacity Per Bin.  
 ITEM 22046-13 | 17¼Wx10½Dx23½H

C. MONTEREY  
**CHAFFER ALTERNATIVES NEW**  
 ITEM 22044-15 | 10Wx10Dx6¾H  
 ITEM 22043-15 | 19¾Wx10Dx6¾H

D. MONTEREY  
**ICE HOUSINGS NEW**  
 Includes White Melamine Ice Pan.  
 ITEM 22020-6-13 | 6½Wx7Dx8H  
 ITEM 22020-10-13 | 12¼Wx9½Dx8½H  
 ITEM 22020-12-13 | 20¼Wx12¼Dx9¼H

Please visit [www.calmil.com/legal](http://www.calmil.com/legal) for a complete list of California Proposition 65 related items.



# MONTEREY collection



DESIGNED WITH SIMPLICITY AND STYLE IN MIND, the Monterey Collection displays a timeless and eclectic theme that can be used in big city galas and farmhouse get-togethers alike. The matte black frames complement the white pieces, while the white further enhances the rustic Madera accents.



# MONTEREY collection



**A. MONTEREY BUTANE STOVE FRAME NEW**

Butane Stove Sold Separately.  
ITEM 22115-15 | 14Wx12¼Dx7¼H  
ITEM 4010-I | Optional Butane Stove

**B. MONTEREY INDUCTION UNIT NEW**

Includes Induction Burner.  
ITEM 22114-15 | 12¾Wx15¾Dx7¼H

**C. MONTEREY REVOLVING CUP & LID ORGANIZER NEW**

Stacking Madera Inserts Sold Separately.  
ITEM 22109-15 | 8Wx8Dx17¾H

**OPTIONAL MADERA INSERTS**

ITEM 22110-99 | Condiment Base  
ITEM 22111-99 | Stir Stick Holder



22111-99

22110-99



**D. MONTEREY SINGLE CEREAL DISPENSER NEW**

Features Pull & Serve Mechanism.  
600 Cubic Inch Capacity.  
ITEM 22067-1-13 | 6½Wx9¼Dx24H

**E. MONTEREY FLATWARE DISPLAY NEW**

Includes Stainless Steel Flatware Holders.  
ITEM 22048-13 | 4½Wx7Dx21H

**F. MONTEREY BREAD CASE NEW**

ITEM 22030-13 | 7Wx13¾Dx20½H

**G. WIRE MELAMINE JAR DISPLAY**

White Melamine Jars Included.  
Specify Color: Black (13), White (15) **NEW**.  
ITEM 22012 | 15½Wx4½Dx6½H  
ITEM C1432BODY | Replacement Jar  
ITEM C1432BODYC | Replacement Jar-Write On



Please visit [www.calmil.com/legal](http://www.calmil.com/legal) for a complete list of California Proposition 65 related items.





H. MONTEREY BAKERY CASE **NEW**  
ITEM 4312-15 | 21Wx17Dx23¼H



I. MONTEREY MERCHANDISERS **NEW**  
ITEM 22024-1-13 | 21Wx12¼Dx4¾H  
ITEM 22024-2-13 | 21Wx12¼Dx14¾H



J



J. MONTEREY DISPLAY CASE **NEW**  
Includes (3) White Composite Shelves.  
ITEM 22021-13 | 21WX18¼DX23H  
ITEM 22116-13 | 26½WX17DX26¾H



K



K. MONTEREY BOX  
MERCHANDISERS **NEW**  
ITEM 22118-4-13 | 20¼Wx10¼Dx4H  
ITEM 22118-7-13 | 20¼Wx10¼Dx7½H

Please visit [www.calmil.com/legal](http://www.calmil.com/legal) for a complete list of California Proposition 65 related items.



# MONTEREY collection



## A. MONTEREY DISPLAY CASE **NEW**

Includes (3) White Composite Shelves.

ITEM 22023-14-13 | 14Wx14Dx26H

ITEM 22023-26-13 | 14Wx26¼Dx26¼H

22078-13



22076-13

22077-15



## B. PRESENTATION DISPLAYS **NEW**

Specify Color: Black (13), White (15).

Featuring a Reversible Design!

Use as a Riser or Flip the Acrylic Case to Have a Box!

ITEM 22076 | 5Wx5Dx6H

ITEM 22077 | 5Wx15Dx5H

ITEM 22078 | 5Wx15Dx7H

## C. MONTEREY CHAFER **NEW**

Features Easy Access Drawer for Chafer Fuel. Includes Stainless Steel Chafer Cover.

ITEM 22113-15 | 22¼Wx14¼Dx12½H



22062-15

D

22061-13

22061-15

## D. WRITE-ON BAGEL DISPLAY **NEW**

Bases and Bagel Sleeves

Sold Separately.

BASES

ITEM 22062-99 | 15Wx16Dx4¼H | Madera

ITEM 22062-15 | 15Wx16Dx4¼H | White

BAGEL SLEEVES

ITEM 22061-13 | 15¼Wx4¾Dx2H | Black

ITEM 22061-15 | 15¼Wx4¾Dx2H | White

Please visit [www.calmil.com/legal](http://www.calmil.com/legal) for a complete list of California Proposition 65 related items.



**E. MONTEREY MODULAR LIBRARY DISPLAY NEW**

All Pieces Sold Separately.

ITEM 22119-3-13 | 14Wx12Dx3¼H | 3" Base

ITEM 22119-13-13 | 14Wx12Dx13¾H | 13" Cube

ITEM 22124-15 | 42Wx12Dx¾H | White Shelf

**F. MONTEREY ROUND RISER NEW**

ITEM 22022-13 | 12DIAx4H

**G. STANDS FOR MELAMINE PLATES NEW**

ITEM 22015-4-15 | 9DIAx4H | Fits 8" Plate

ITEM 22015-7-15 | 9DIAx7H | Fits 8" Plate

ITEM 22016-4-15 | 11DIAx4H | Fits 10" Plate

ITEM 22016-7-15 | 11DIAx7H | Fits 10" Plate

ITEM 22125-4-15 | 13DIAx4H | Fits 12" Plate

ITEM 22125-7-15 | 13DIAx7H | Fits 12" Plate

**H. MELAMINE PLATES NEW**

Plates and Stands Sold Separately.

ITEM 22017-8 | 8¼Dx1½H

ITEM 22017-10 | 10Dx1½H

ITEM 22017-12 | 12Dx1½H



Please visit [www.calmil.com/legal](http://www.calmil.com/legal) for a complete list of California Proposition 65 related items.



# EMPIRE collection



**A. EMPIRE BEVERAGE DISPENSER NEW**  
3 Gallon Capacity.  
Includes Chamber and Drip Tray.  
ITEM 22090-3-90 | 8½Wx10Dx24¾H | Ice Chamber  
ITEM 22090-3INF-90 | 8½Wx10Dx24¾H | Infusion Chamber

**B. EMPIRE BREAD CASE NEW**  
ITEM 22088-90 | 13Wx11¼Dx13¼H

**C. EMPIRE BUTANE STOVE FRAME NEW**  
ITEM 22089-90 | 14¼Wx13Dx7¼H  
ITEM 4010-I | Optional Butane Stove

**D. EMPIRE 9 SECTION ORGANIZER NEW**  
ITEM 22093-90 | 11¾Wx11½Dx6H

Please visit [www.calmil.com/legal](http://www.calmil.com/legal) for a complete list of California Proposition 65 related items.

# EMPIRE collection



**BOTH EXTRAVAGANT AND MINIMALIST, THE EMPIRE COLLECTION** was designed to add a luxurious element to any presentation. The flat black color adds a dynamic contrast to any number of possible food colors while the striking gold frames deliver a constant theme throughout the entire collection.



# EMPIRE collection



A

## A. EMPIRE CHAFER ALTERNATIVES **NEW**

ITEM 22084-90 | 10Wx10¼Dx7½H

ITEM 22083-90 | 10Wx19¾Dx7½H

## B. LID HOLDER CHAFER ALTERNATIVE ATTACHMENT **NEW**

Fits all Chafer Alternative Grills.

ITEM 22045 | 1¾Wx6Dx4½H

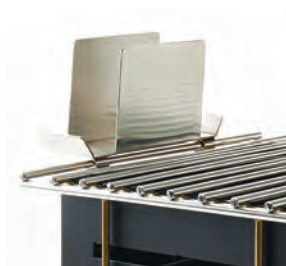

B

## C. EMPIRE CYLINDER DISPLAY **NEW**

Cylinders Sold Separately.

ITEM 22086-90 | 7Wx7¼Dx18½H

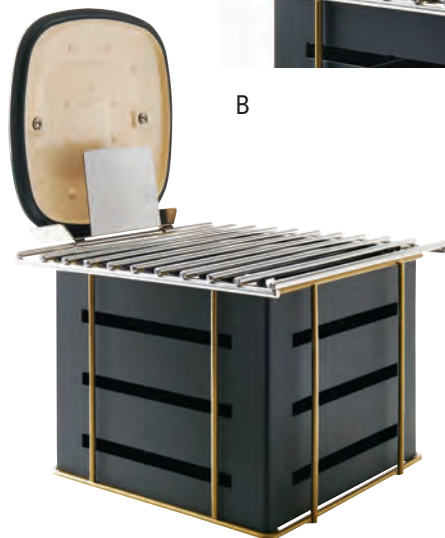

C

## D. OPTIONAL CYLINDERS

Available in Six Colors.

Stainless Steel Style: Perforated (39),  
(SOLID).

Colored Melamine: Black (13), White (15),  
Butter Yellow (61), Terra Cotta (62),  
Sage (63), Cranberry (64).

Extra Deep: White (8-15).

ITEM 1017-39 | 4½DIAx5½H

ITEM 1017-SOLID | 4½DIAx5½H

ITEM 1017 | 4½DIAx5½H

ITEM 1017-8-15 | 4½DIAx8H | Extra Deep



D

SOLID

8-15

61

62

63

64

15

13

39

Please visit [www.calmil.com/legal](http://www.calmil.com/legal) for a complete list of California Proposition 65 related items.



**E. EMPIRE ICE HOUSINGS NEW**  
Includes Clear Polycarbonate Pan.  
ITEM 22085-10-90 | 13¾Wx11Dx6¾H  
ITEM 22085-12-90 | 22Wx13½Dx6¾H



**F. EMPIRE RECTANGLE RISERS NEW**  
ITEM 22087-5-90 | 20½Wx7Dx5H  
ITEM 22087-9-90 | 20½Wx7Dx9H  
ITEM 22087-13-90 | 20½Wx7Dx13H

**G. EMPIRE JAR DISPLAYS NEW**  
Glass Jars Included.  
ITEM 22091-90 | 12½Wx4½Dx5¼H | 3 Jar  
ITEM 22092-90 | 12½Wx8½Dx5¼H | 6 Jar  
ITEM C4X4GLCN | Replacement Glass Jar



Please visit [www.calmil.com/legal](http://www.calmil.com/legal) for a complete list of California Proposition 65 related items.



# PORTLAND collection

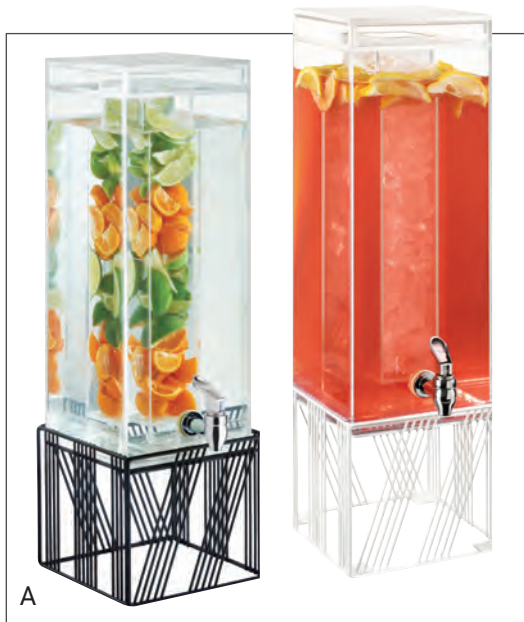

A



B



C



D

**A. PORTLAND BEVERAGE DISPENSERS**  
3 Gallon Capacity. Includes Chamber and Drip Tray.  
Specify Color: Black (13), White (15) **NEW**.  
ITEM 4102-3 | 8Wx8Dx25H | Ice Chamber  
ITEM 4102-3INF | 8Wx8Dx25H | Infusion Chamber

**B. PORTLAND CHAFER**  
Includes Stainless Steel Cover.  
Specify Color: Black (13), White (15) **NEW**.  
ITEM 4113 | 22Wx13½Dx12H

**C. PORTLAND CASE DISPLAY**  
Includes 3 – 13x18 Clear Trays.  
Self and Attendant Serve with 3 Tray Positions.  
Specify Color: Black (13), White (15) **NEW**.  
ITEM 4112 | 19½Wx14½Dx20½H

**D. PORTLAND CHAFER ALTERNATIVES**  
Specify Color: Black (13), White (15) **NEW**.  
ITEM 4106 | 10¼Wx10Dx7½H  
ITEM 4107 | 19¾Wx10Dx5¾H

Please visit [www.calmil.com/legal](http://www.calmil.com/legal) for a complete list of California Proposition 65 related items.



# PORTLAND collection



WITH ITS STREAMLINED, MODERN AESTHETIC, the Portland Collection creates a beautiful blend of vibrance and elegance. The distinct wire pattern expresses a contemporary edginess while maintaining a very attractive price point that is sure to upgrade any presentation.



# PORTLAND collection



A

## A. PORTLAND ICE HOUSINGS

Includes Clear Polycarbonate Pan.  
Specify Color: Black (13), White (15) **NEW**

ITEM 41115-6 | 6½Wx7Dx8¼H

ITEM 41115-10 | 13Wx13¼Dx8¼H

ITEM 41115-12 | 21Wx13¼Dx8¼H



B

## B. PORTLAND MERCHANDISER CART

Includes Clear Insert Trays.  
Specify Color: Black (13), White (15) **NEW**

ITEM 4111 | 15Wx14Dx35H

Please visit [www.calmil.com/legal](http://www.calmil.com/legal) for a complete list of California Proposition 65 related items.



C

**C. PORTLAND SQUARE RISERS**

Specify Color: Black (13),  
White (15) **NEW.**

ITEM 432-3 | 12Wx12Dx3H

ITEM 432-6 | 12Wx12Dx6H

ITEM 432-9 | 12Wx12Dx9H



D

**D. PORTLAND RECTANGULAR RISERS**

Specify Color: Black (13),  
White (15) **NEW.**

ITEM 4103-3 | 20¼Wx7Dx3H

ITEM 4103-7 | 20¼Wx7Dx7H

ITEM 4103-11 | 20¼Wx7Dx11H



E

**E. PORTLAND INDUCTION UNIT**

Includes Induction Burner.  
Specify Color: Black (13), White (15) **NEW.**

ITEM 4100 | 12¼Wx15½Dx7H



F

**F. PORTLAND BUTANE STOVE FRAME**

Butane Stove Sold Separately.  
Specify Color: Black (13), White (15) **NEW.**

ITEM 4109 | 13Wx14Dx7½H

ITEM 4010-I | Optional Butane Stove

Please visit [www.calmil.com/legal](http://www.calmil.com/legal) for a complete list of California Proposition 65 related items.



# PORTLAND collection



A



## A. PORTLAND BREAD DISPLAY

Specify Color: Black (13), White (15) **NEW**.

ITEM 4119 | 22½Wx14¾Dx7H



B

## B. WIRE MELAMINE JAR DISPLAY

White Melamine Jars Included.

Specify Color: Black (13), White (15) **NEW**.

ITEM 22012 | 15½Wx4½Dx6½H

ITEM C1432BODY | Replacement Jar

ITEM C1432BODYC | Replacement Jar-Write On

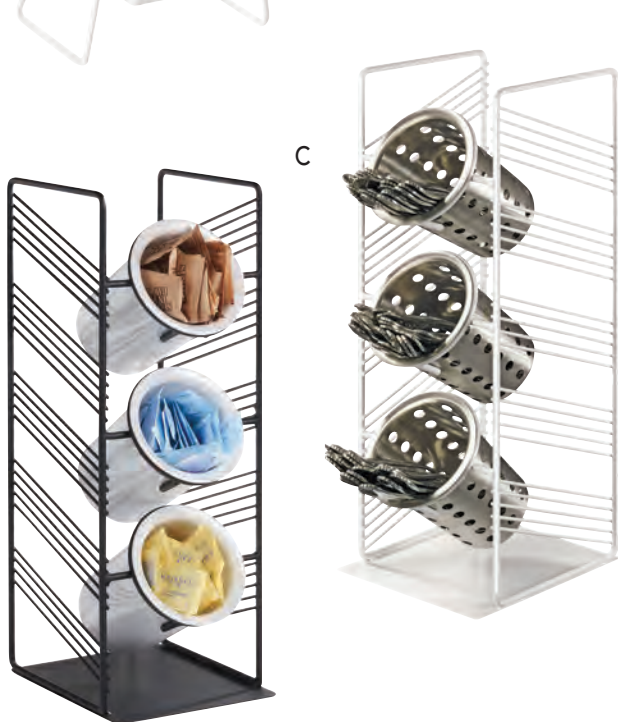

C



## C. PORTLAND VERTICAL CYLINDER DISPLAY

Cylinders Sold Separately.

Specify Color: Black (13), White (15) **NEW**

ITEM 4105 | 6¾Wx7¾Dx19H

ITEM 4105 | 6¾Wx7¾Dx19H

### OPTIONAL CYLINDERS

Available in Six Colors.

Stainless Steel Style: Perforated (39), (SOLID).  
Colored Melamine: Black (13), White (15),  
Butter Yellow (61), Terra Cotta (62), Sage (63),  
Cranberry (64). Extra Deep: White (8-15).

ITEM 1017-39 | 4½DIAx5½H

ITEM 1017-SOLID | 4½DIAx5½H

ITEM 1017 | 4½DIAx5½H

ITEM 1017-8-15 | 4½DIAx8H | Extra Deep

Please visit [www.calmil.com/legal](http://www.calmil.com/legal) for a complete list of California Proposition 65 related items.





D

D. PORTLAND JAR DISPLAYS

Glass Jars Included.

Specify Color: Black (13), White (15) **NEW**.

ITEM 4101-3 | 12½Wx4½Dx5¼H

ITEM 4101-6 | 12½Wx8½Dx5¼H

ITEM 1807 | S/S Hinge Lid for C4X4GLCN



E

E. PORTLAND SMALL BASKET

Specify Color: Black (13), White (15) **NEW**.

ITEM 4114-6 | 6DIAx5½H



F

F. PORTLAND LARGE BASKET

Specify Color: Black (13), White (15) **NEW**.

ITEM 4114-10 | 10½DIAx5½H



Please visit [www.calmil.com/legal](http://www.calmil.com/legal) for a complete list of California Proposition 65 related items.



# PORTLAND collection



A

## A. PORTLAND REVOLVING CUP & LID ORGANIZER

Holds up to 3.75" Diameter Cups & Lids.  
Specify Color: Black (13), White (15) **NEW**

ITEM 4104 | 8¾WX8¾DX17¾H



B

## B. PORTLAND CEREAL DISPENSER

Features Pull & Serve Mechanism.  
600 Cubic Inch Capacity Per Bin.

Specify Color: Black (13), White (15) **NEW**

ITEM 4108 | 16WX9DX23½H



Please visit [www.calmil.com/legal](http://www.calmil.com/legal) for a complete list of California Proposition 65 related items.

C. PORTLAND LIBRARY DISPLAY  
Ships by Truck Only.  
Specify Color: Black (13), White (15) **NEW**  
ITEM 4110 | 37½WX13½DX24H



C



Please visit [www.calmil.com/legal](http://www.calmil.com/legal) for a complete list of California Proposition 65 related items.

**CAL•MIL** | visit us online at: [www.calmil.com](http://www.calmil.com) | call toll-free 800-321-9069



# GRANADA collection



A



B



C



Design Your Own  
Custom Insert!

## A. GRANADA 9 JAR DISPLAY

White Melamine Jars Included.

ITEM 4035-85 | 13Wx8Dx13¼H

## B. GRANADA BEVERAGE DISPENSERS

3 Gallon Capacity. Includes Drip Tray.

ICE CHAMBER

ITEM 4027-3-85 | 8¼Wx8¼Dx25½H

INFUSION CHAMBER

ITEM 4027-3INF-85 | 8¼Wx8¼Dx25½H

## C. GRANADA CEREAL DISPENSER

Features Pull & Serve Mechanism.

942 Cubic Inch Capacity.

ITEM 4024-85 | 17¼Wx13¼Dx24H

## CUSTOM NOW COMES STANDARD!

The Granada Collection now proudly features removable tiles to easily customize your presentation! The beautiful Granada tile can be reversed for a plain white background, or simply place the design of your choice between the Granada tile and clear anti-glare tile to have a 100% custom display in moments!

Please visit [www.calmil.com/legal](http://www.calmil.com/legal) for a complete list of California Proposition 65 related items.



# GRANADA collection



INSPIRED BY THE CLASSIC ARCHITECTURE OF SPAIN, the Granada Collection displays sleek flat black frames, accented with bold tile designs. The painted steel provides exceptional durability, while the traditional-styled white tiles proudly help to create a classic yet upscale design.



# GRANADA collection



Design Your Own Custom Insert!

A

## A. GRANADA ICE HOUSINGS

Includes Clear Polycarbonate Pan.

ITEM 4018-6-85 | 7Wx7½Dx6¾H

ITEM 4018-10-85 | 11Wx13¼Dx6¾H

ITEM 4018-12-85 | 13½Wx21¼Dx6¾H



Design Your Own Custom Insert!

B

## B. GRANADA JAR DISPLAYS

Includes Glass Jars.

ITEM 4031-3-85 | 13Wx5Dx4¼H

ITEM 4031-6-85 | 13Wx9¼Dx4¼H



## C. GRANADA REVOLVING CUP AND LID ORGANIZER

Holds Up to 3.75" Diameter Cups & Lids.

ITEM 4017-85 | 8¼Wx8¼Dx17H

## D. GRANADA CYLINDER DISPLAY

Melamine Cylinders Sold Separately.

ITEM 4019-85 | 7¼Wx6½Dx18¼H

### OPTIONAL CYLINDERS

Available in Six Colors.

Stainless Steel Style: Perforated (39), (SOLID).  
Colored Melamine: Black (13), White (15),  
Butter Yellow (61), Terra Cotta (62), Sage (63),  
Cranberry (64). Extra Deep: White (8-15).

ITEM 1017-39 | 4½DIAx5½H

ITEM 1017-SOLID | 4½DIAx5½H

ITEM 1017 | 4½DIAx5½H

ITEM 1017-8-15 | 4½DIAx8H - Extra Deep

Please visit [www.calmil.com/legal](http://www.calmil.com/legal) for a complete list of California Proposition 65 related items.



Now a reversible design for self or attendant serve! Featuring 3 different tray positions: tilted front, tilted back, and level.

E

**E. GRANADA CASE DISPLAY**

Includes 3 — 13" x 18" Clear Acrylic Trays.  
Self and Attendant Serve with 3 Tray Positions.  
ITEM 4034-85 | 19¼Wx13½Dx20¼H



F

**F. GRANADA 3 TIER BREAD DISPLAY**

ITEM 4022-85 | 6¾Wx14¾Dx20½H

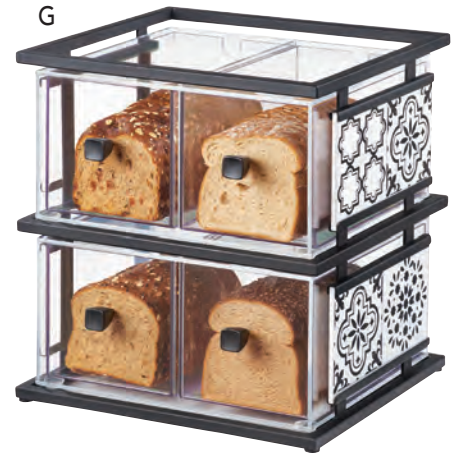

G

**G. GRANADA BREAD DISPLAY**

ITEM 4025-85 | 19Wx14¼Dx20¼H

**H. GRANADA  
9 SECTION ORGANIZER**

Includes Removable Acrylic Insert for Easy Cleaning.  
ITEM 4033-85 | 12Wx12Dx4½H



H

**I. GRANADA  
FLATWARE ORGANIZER**

Includes Removable Acrylic Insert for Easy Cleaning.  
ITEM 4032-85 | 9½Wx6¾Dx5½H



Design Your Own Custom Insert!

Please visit [www.calmil.com/legal](http://www.calmil.com/legal) for a complete list of California Proposition 65 related items.



# GRANADA collection



A



B

C



D



## A. GRANADA CHAFER ALTERNATIVES

ITEM 4020-85 | 10 $\frac{1}{4}$ Wx10Dx5 $\frac{1}{2}$ H

ITEM 4021-85 | 19 $\frac{3}{4}$ Wx10Dx5 $\frac{1}{2}$ H

## B. GRANADA CHAFER

Features Easy Access Drawer for Chafer Fuel.  
Includes Stainless Steel Cover.

ITEM 4016-85 | 22Wx14Dx12 $\frac{1}{4}$ H

## C. GRANADA SNEEZEGUARD STATION

Includes Base, Tiles, and Sneezeguard.

ITEM 4000-86 | 27 $\frac{1}{4}$ Wx18 $\frac{3}{4}$ Dx19 $\frac{3}{4}$ H

ITEM 4000-86TILE | Replacement Tile

## D. GRANADA SERVING TRAY

Includes Removable Melamine Tile For Easy Cleaning.

ITEM 436-3-86 | 24Wx13 $\frac{3}{4}$ Dx3H

ITEM 436-6-86 | 24Wx13 $\frac{3}{4}$ Dx6H

ITEM 436-9-86 | 24Wx13 $\frac{3}{4}$ Dx9H

## E. GRANADA SERVING TILES

Made of Melamine For Easy Cleaning.

ITEM 3732-86 | 6Wx6Dx $\frac{3}{4}$ H

ITEM 3731-86 | 12Wx6Dx $\frac{3}{4}$ H

E



Please visit [www.calmil.com/legal](http://www.calmil.com/legal) for a complete list of California Proposition 65 related items.



F



Design Your Own Custom Insert!



**F. GRANADA SQUARE RISERS**

ITEM 4029-3-85 | 12½Wx12½Dx4H

ITEM 4029-6-85 | 12½Wx12½Dx6H

ITEM 4029-9-85 | 12½Wx12½Dx9H



G

Design Your Own Custom Insert!



**G. GRANADA RECTANGLE RISERS**

ITEM 4030-3-85 | 20½Wx7½Dx4¼H

ITEM 4030-7-85 | 20½Wx7½Dx7¼H

ITEM 4030-11-85 | 20½Wx7½Dx11¼H

**H. GRANADA BUTANE STOVE FRAME**

Butane Stove Sold Separately.

ITEM 4028-85 | 13Wx14½Dx7½H

ITEM 4010-I | Optional Butane Stove



H



I

**I. GRANADA INDUCTION BURNER**

Includes Induction Burner.

ITEM 4026-85 | 12¾Wx16Dx7¾H

**J. GRANADA COLD CONCEPT BASE**

Stainless Steel Cold Bowl Sold Separately.

ITEM 4023-85 | 12Wx12Dx5¼H

ITEM 3326-10-55 | Stainless Steel Cold Bowl



J



K

**K. GRANADA PLATE/NAPKIN HOLDER NEW**

Fits 10" Plates and 4"x8" Napkins.

ITEM 22068-85 | 10¼Wx15Dx8¼H

Please visit [www.calmil.com/legal](http://www.calmil.com/legal) for a complete list of California Proposition 65 related items.



# CINDERWOOD collection



A



B



C



D

## A. CINDERWOOD ACRYLIC BEVERAGE DISPENSER

3 Gallon Capacity.

Includes Ice Chamber and Drip Tray.

ITEM 3804-3-87 | 8Wx8Dx26H | Ice Chamber

ITEM 3804-3INF-87 | 8Wx8Dx26H | Infusion Chamber

## C. CINDERWOOD CEREAL DISPENSER

Features Pull & Serve Mechanism.

600 Cubic Inch Capacity Per Bin.

ITEM 3823-87 | 17½Wx9½Dx24H

## B. CINDERWOOD BREAD DISPLAY

ITEM 3820-87 | 20Wx13½Dx15H

## D. CINDERWOOD CHAFER

Features Easy Access Drawer for Chafer Fuel.

Includes Stainless Steel Chafer Cover.

ITEM 3828-87 | 22Wx14Dx13½H

Please visit [www.calmil.com/legal](http://www.calmil.com/legal) for a complete list of California Proposition 65 related items.

# CINDERWOOD

collection



DARK STAINED OAK AND GLOSSY PLATED CHROME work in harmony to create the perfect contrast of dark and light. The color of the oak entices the guest to take a closer view and see the cinematic grains, while light plays off the chrome accents to exhibit a stunning and upscale display.



# CINDERWOOD collection



## A. NOTCHED SHELVES & BRACKETS

ITEM 3826-1124-87 | 24Wx11Dx1/2H

ITEM 3826-1132-87 | 32Wx11Dx1/2H

### BRACKETS

ITEM 3827-49 | Pair of Chrome Brackets 11Wx2 1/4H

## B. CINDERWOOD MARBLE RISERS

9" and 13" Risers Feature Slots for Brackets to Position Shelves. Includes Melamine Marble Tray.

ITEM 3822-6-87 | 15Wx11Dx6 1/4H

ITEM 3822-9-87 | 15Wx11Dx9 1/4H

ITEM 3822-13-87 | 15Wx11Dx13 1/4H

Please visit [www.calmil.com/legal](http://www.calmil.com/legal) for a complete list of California Proposition 65 related items.



**C. CINDERWOOD ICE HOUSINGS**

Includes Clear Polycarbonate Pan.

ITEM 3800-6-87 | 7½Wx7½Dx7H

ITEM 3800-10-87 | 13¼Wx11Dx7¼H

ITEM 3800-12-87 | 21¼Wx13¼Dx7H



D

**D. CINDERWOOD BUTANE STOVE FRAME**

Optional Butane Stove Sold Separately.

ITEM 3816-87 | 12Wx14Dx7½H

ITEM 4010-I | Optional Butane Stove



E

**E. CINDERWOOD INDUCTION UNIT**

Includes Induction Burner.

ITEM 3633-87 | 15½Wx12½Dx7H



F

**F. CINDERWOOD CHAFER ALTERNATIVES**

ITEM 3814-87 | 10¼Wx10Dx5½H

ITEM 3813-87 | 19¾Wx10Dx5½H

Please visit [www.calmil.com/legal](http://www.calmil.com/legal) for a complete list of California Proposition 65 related items.



# CINDERWOOD collection



A



B

**A. CINDERWOOD REVOLVING CUP & LID ORGANIZER**  
Holds Up to 3.75" Diameter Cups & Lids.  
ITEM 3803-87 | 10Wx10Dx18¼H

**B. CINDERWOOD VERTICAL BREAD CASE**  
ITEM 3815-87 | 6½Wx13Dx20¼H



C



**C. CINDERWOOD CARDHOLDERS**  
ITEM 3825-23-87 | 3½Wx2H | Card Size  
ITEM 3825-46-87 | 4Wx6H | Card Size  
ITEM 3825-811-87 | 8½Wx11H | Card Size



D

**D. CINDERWOOD CHALKBOARD SIGNS**  
ITEM 3818-23-87 | 3Wx2H | Chalkboard Size  
ITEM 3818-46-87 | 4Wx6H | Chalkboard Size  
ITEM 3818-811-87 | 8½Wx11H | Chalkboard Size

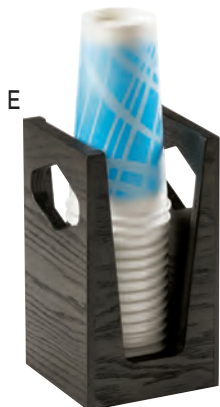

E



F

**E. CINDERWOOD CUP AND LID HOLDER**  
Holds Up to 3.75" Diameter Cups & Lids.  
ITEM 3812-87 | 5Wx5Dx9H

**F. CINDERWOOD NAPKIN HOLDER**  
ITEM 3810-87 | 4Wx8D | Napkin Size

Please visit [www.calmil.com/legal](http://www.calmil.com/legal) for a complete list of California Proposition 65 related items.

G. CINDERWOOD  
CONDIMENT DISPLAY  
ITEM 3801-87 | 13Wx13½Dx6¼H



H. CINDERWOOD MULTI-SECTION  
CONDIMENT ORGANIZER  
Plastic Liner Removable For Easy Cleaning.  
ITEM 3809-87 | 12Wx12Dx6H



I. CINDERWOOD  
FLATWARE DISPLAY  
Plastic Insert Removable For Easy Cleaning.  
ITEM 3811-87 | 9½Wx6¾Dx4¾H



J. CINDERWOOD  
FLATWARE ORGANIZER  
ITEM 3819-87 | 15¼Wx5½Dx4½H





# CINDERWOOD collection



A

A. CINDERWOOD HEXAGON RISERS

ITEM 435-5-87 | 12DIAx5H

ITEM 435-8-87 | 12DIAx8H

ITEM 435-11-87 | 12DIAx11H



B

B. CINDERWOOD 3 JAR HOLDER

Includes Glass Jars.

ITEM 3806-87 | 12¾Wx5Dx5¼H

ITEM C4X4GLCN | Replacement Glass Jar



C

C. CINDERWOOD 6 JAR HOLDER

Includes Glass Jars.

ITEM 3805-87 | 12¾Wx9Dx5¼H

ITEM C4X4GLCN | Replacement Glass Jar



D

D. CINDERWOOD  
FLATWARE ORGANIZER

ITEM 3802-87 | 13¾Wx11½Dx3¼H

Please visit [www.calmil.com/legal](http://www.calmil.com/legal) for a complete list of California Proposition 65 related items.



3698-6-87 Shown with  
Optional Accessory Top  
Shelf 3698-6-87SHELF.

**E. U-BUILD CINDERWOOD CARTS**

Cart Includes 3 Large Shelves, Support Beams, and Wheels. Small Accessory Top Shelf (Pictured Above) Sold Separately.  
Ships by Truck Only.

ITEM 3698-4-87 | 48Wx24Dx44H

ITEM 3698-6-87 | 72Wx24Dx44H

**OPTIONAL ACCESSORIES**

ITEM 3698-4-87SHELF | 48" Accessory Top Shelf

ITEM 3698-6-87SHELF | 72" Accessory Top Shelf



Please visit [www.calmil.com/legal](http://www.calmil.com/legal) for a complete list of California Proposition 65 related items.



# ASHWOOD collection



**A. ASHWOOD ACRYLIC BEVERAGE DISPENSER**  
3 Gallon Capacity. Includes Chamber and Drip Tray.  
ITEM 3804-3-83 | 8Wx8Dx26H Ice Chamber  
ITEM 3804-3INF-83 | 8Wx8Dx26H Infusion Chamber

**B. ASHWOOD BREAD DISPLAY**  
ITEM 3820-83 | 20Wx13½Dx15H

**C. ASHWOOD CEREAL DISPENSER**  
Features Pull & Serve Mechanism.  
600 Cubic Inch Capacity Per Bin.  
ITEM 3823-83 | 17½Wx9½Dx24H

**D. ASHWOOD CHAFER**  
Features Easy Access Drawer for Chafer Fuel.  
Includes Stainless Steel Chafer Cover.  
ITEM 3828-83 | 22Wx14Dx13½H

Please visit [www.calmil.com/legal](http://www.calmil.com/legal) for a complete list of California Proposition 65 related items.

# ASHWOOD collection



COMPRISED OF DRAMATIC OAK AND CHROME, the Ashwood Collection caters to displays looking for a taste of grandeur. The elegant gray-washed oak contrasts tastefully with the chrome frames and accents, creating the perfect balance of symmetry and refinement.



# ASHWOOD collection



B



A

## A. NOTCHED SHELVES & BRACKETS

ITEM 3826-1124-83 | 24Wx11Dx½H

ITEM 3826-1132-83 | 32Wx11Dx½H

### BRACKETS

ITEM 3827-49 | Pair of Chrome Brackets 11Wx2¼H

## B. ASHWOOD MARBLE RISERS

9" and 13" Risers Feature Slots for Brackets to Position Shelves. Includes Melamine Marble Tray.

ITEM 3822-6-83 | 15Wx11Dx6¼H

ITEM 3822-9-83 | 15Wx11Dx9¼H

ITEM 3822-13-83 | 15Wx11Dx13¼H

Please visit [www.calmil.com/legal](http://www.calmil.com/legal) for a complete list of California Proposition 65 related items.



**C. ASHWOOD ICE HOUSINGS**  
Includes Clear Polycarbonate Pan.  
ITEM 3800-6-83 | 7½Wx7½Dx7H  
ITEM 3800-10-83 | 13¼Wx11Dx7¼H  
ITEM 3800-12-83 | 21¼Wx13¼Dx7H



**D. ASHWOOD BUTANE STOVE FRAME**  
Optional Butane Stove Sold Separately.  
ITEM 3816-83 | 12Wx14Dx7½H  
ITEM 4010-I | Optional Butane Stove

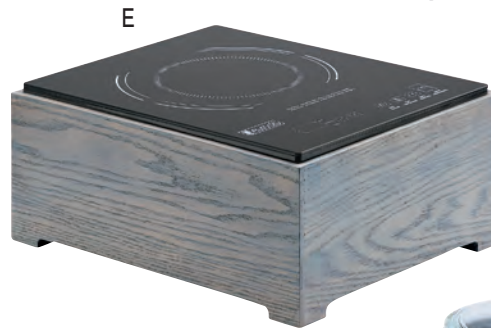

**E. ASHWOOD INDUCTION UNIT**  
Includes Induction Burner.  
ITEM 3633-83 | 12¾Wx16Dx7¼H



**F. ASHWOOD CHAFER ALTERNATIVES**  
ITEM 3814-83 | 10¼Wx10Dx5½H  
ITEM 3813-83 | 19¾Wx10Dx5½H

Please visit [www.calmil.com/legal](http://www.calmil.com/legal) for a complete list of California Proposition 65 related items.



# ASHWOOD collection



**A. ASHWOOD REVOLVING CUP & LID ORGANIZER**  
 Holds Up to 3.75" Diameter Cups & Lids.  
 ITEM 3803-83 | 10Wx10Dx18¼H

**B. ASHWOOD BREAD CASE**  
 ITEM 3815-83 | 6½Wx13Dx20¼H

**C. ASHWOOD ADJUSTABLE CONDIMENT HOLDER **NEW****  
 Easily Change Depth to Better Show Condiments.  
 ITEM 22096-83 | 7½Wx7½Dx7H

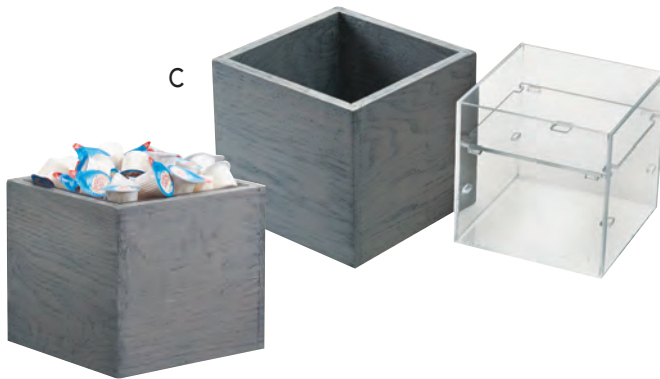

**D. ASHWOOD CARDHOLDERS**  
 ITEM 3825-23-83 | 3½Wx2H | Card Size  
 ITEM 3825-46-83 | 4Wx6H | Card Size  
 ITEM 3825-811-83 | 8½Wx11H | Card Size

**E. ASHWOOD CHALKBOARDS**  
 ITEM 3818-23-83 | 3½Wx2H | Chalkboard Size  
 ITEM 3818-46-83 | 4Wx6H | Chalkboard Size  
 ITEM 3818-811-83 | 8½Wx11H | Chalkboard Size



Please visit [www.calmil.com/legal](http://www.calmil.com/legal) for a complete list of California Proposition 65 related items.



**F. ASHWOOD CONDIMENT DISPLAY**  
3801-83 | 13Wx13½Dx6¼H



**G. ASHWOOD JAR DISPLAYS**  
Includes Glass Jars.  
ITEM 3806-83 | 12¾Wx5Dx4½H - w/ 3 Jars  
ITEM 3805-83 | 12¾Wx9Dx4½H - w/ 6 Jars  
ITEM C4X4GLCN | Replacement Glass Jar



**H. ASHWOOD  
PLATE/NAPKIN HOLDER **NEW****  
Fits 4x8 Napkins and 10" Plates.  
ITEM 22068-83 | 10¼Wx15Dx8H



**I. ASHWOOD  
CUP & LID HOLDER**  
Holds up to 3.75" Diameter Cups & Lids.  
ITEM 3812-83 | 5Wx5Dx9H



**J. ASHWOOD MULTI-SECTION  
CONDIMENT ORGANIZER**  
Plastic Liner Removable For Cleaning.  
ITEM 3809-83 | 12Wx12Dx6H

Please visit [www.calmil.com/legal](http://www.calmil.com/legal) for a complete list of California Proposition 65 related items.



# ASHWOOD collection



2053-83

2054-83

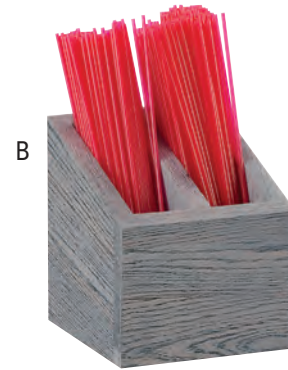

B

## A. ASHWOOD 3 TIER CONDIMENT DISPLAY

ITEM 2053-83 | 5½Wx6½Dx15½H

ITEM 2054-83 | 10½Wx6½Dx15½H



C

## B. ASHWOOD STIR-STICK HOLDER

ITEM 3308-83 | 5Wx5Dx5½H

## C. ASHWOOD SERVING TRAY

ITEM 3701-83 | 12Wx12Dx3½H



D

## D. ASHWOOD CRUMB CATCHER

Includes Removable Tray For Easy Cleaning.

ITEM 823-83 | 13½Wx7¾Dx1½H



E

## E. ASHWOOD 9 JAR DISPLAY

Glass Jars Sold Separately.

ITEM 3831-83 | 13¼Wx12½Dx6½H

ITEM C4X4GLCN | Replacement Glass Jar

Please visit [www.calmil.com/legal](http://www.calmil.com/legal) for a complete list of California Proposition 65 related items.



F



**F. ASHWOOD CASE DISPLAY**

Includes 3 Clear Acrylic Trays.  
Self and Attendant Serve  
with 3 Tray Positions.

ITEM 3838-83 | 20Wx14¼Dx20½H

**G. ASHWOOD CEREAL DISPENSER NEW**

Features Pull & Serve Mechanism.  
600 Cubic Inch Capacity Per Bin.

ITEM 22067-1-83 | 6½Wx9¼Dx24H

G



**H. ASHWOOD 3 TIER DISPLAY CASE**

Includes 3 Removable Trays.  
Attendant Serve Only.

ITEM 3830-83 | 11¼Wx13½Dx15H

H



**I. ASHWOOD CARAFE COOLERS NEW**

Includes Condensation Liner and Cold Pucks.  
Carafes Sold Separately.

ITEM 22082-83 | 5¼Wx14½Dx7H | Fits 3614-55

ITEM 22081-83 | 5¾Wx7½Dx7H | Fits 3551-55

**CARAFES**

ITEM 3614-55 | 4DIAx10H

ITEM 3551-55 | 4DIAx13H



I



Please visit [www.calmil.com/legal](http://www.calmil.com/legal) for a complete list of California Proposition 65 related items.



# ASHWOOD collection

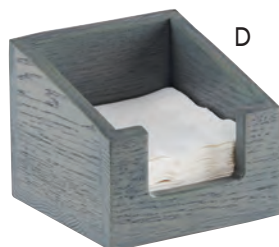
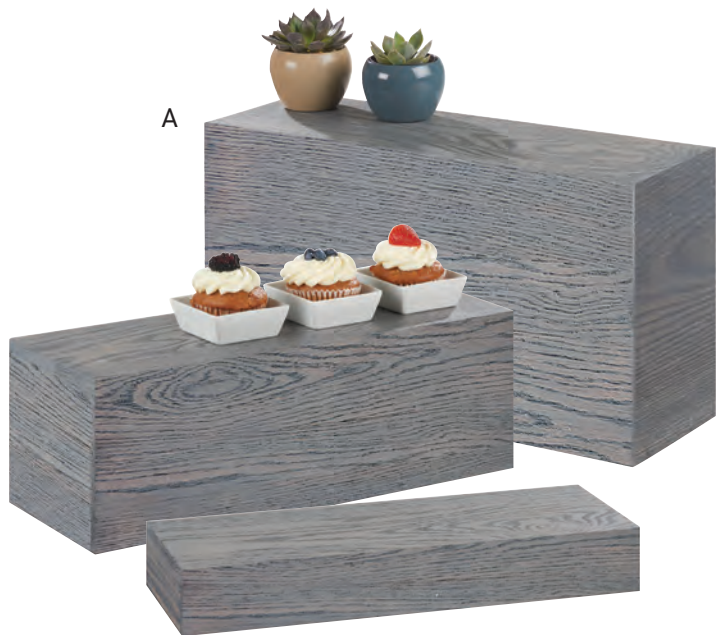

## A. ASHWOOD RECTANGLE RISERS

ITEM 166-3-83 | 20Wx7Dx3H

ITEM 166-7-83 | 20Wx7Dx7H

ITEM 166-11-83 | 20Wx7Dx11H

## B. ASHWOOD HEXAGON RISERS

ITEM 435-5-83 | 12DIAx5H

ITEM 435-8-83 | 12DIAx8H

ITEM 435-11-83 | 12DIAx11H

## C. ASHWOOD NAPKIN HOLDER

ITEM 3810-83 | 4Wx8H | Napkin Size

## D. ASHWOOD BAR NAPKIN HOLDER **NEW**

ITEM 3309-83 | 5Wx5H | Napkin Size

## E. ASHWOOD FLATWARE DISPLAY

Plastic Insert Removable for Easy Cleaning.

ITEM 3811-83 | 9½Wx6¾Dx4¾H

## F. ASHWOOD FLATWARE ORGANIZER

ITEM 3819-83 | 15Wx6Dx3H

## G. ASHWOOD FLATWARE ORGANIZER

ITEM 3802-83 | 13¾Wx10Dx6H

Please visit [www.calmil.com/legal](http://www.calmil.com/legal) for a complete list of California Proposition 65 related items.



3836-3-83



3837-3-83



#### H. ASHWOOD INDUCTION STATION

All Pieces Sold Separately. Jar Holders and 1/6 Pan Holders Include Cold Pucks. Jars and Pans Included.

ITEM 3633-83 | 12 $\frac{3}{4}$ Wx16Dx7 $\frac{1}{4}$ H | Induction Burner

ITEM 3836-3-83 | 15 $\frac{3}{4}$ Wx5 $\frac{1}{2}$ Dx8 $\frac{3}{4}$ H | Jar Holder

ITEM 3837-3-83 | 11 $\frac{3}{4}$ Wx7 $\frac{1}{2}$ Dx6 $\frac{1}{4}$ H | 1/6 Pan Holder

#### I. ASHWOOD BEVERAGE CART

Cart Only.

Beverage Dispenser and Accessories Sold Separately.

ITEM 3834-83 | 31Wx20 $\frac{1}{2}$ Dx39 $\frac{1}{4}$ H

##### OPTIONAL ACCESSORIES

ITEM 1111 Beverage Dispenser

ITEM 3836-3-83 | Jar Holder

ITEM 3800-10-83 | Ice Housing



Please visit [www.calmil.com/legal](http://www.calmil.com/legal) for a complete list of California Proposition 65 related items.



# ASHWOOD collection



**A. ASHWOOD FRAME RISER**

ITEM 3708-83 | 32Wx13¼Dx25H



**B. ASHWOOD MIXOLOGY DISPLAY**

Includes Frame, Jar Base, Lid, Jar, and Cold Puck.

ITEM 1850-4-83 | 14¼Wx6Dx5H

ITEM 1850-5-83 | 17¼Wx7Dx6H

**C. ASHWOOD MERCHANDISERS**

ITEM 3449-2-83 | 16Wx20Dx9½H

ITEM 3449-3-83 | 16Wx20Dx15½H



**D. ASHWOOD MARBLE RISERS**

Includes Melamine Marble Trays.

ITEM 3680-126-81M | 12DIAx6H

ITEM 3680-153-81M | 15DIAx3¼H

REPLACEMENT TRAYS

ITEM 3656-12-81M | 12DIAx¾H

ITEM 3656-15-81M | 15DIAx¾H

Please visit [www.calmil.com/legal](http://www.calmil.com/legal) for a complete list of California Proposition 65 related items.



3698-6-83 Shown with  
Optional Accessory Top Shelf  
3698-6-83SHELF.

**E. ASHWOOD U-BUILD CART**

Cart Includes 3 Large Shelves, Support  
Beams, and Wheels.  
Small Accessory Top Shelf Sold Separately.  
Ships by Truck Only.

ITEM 3698-4-83 | 48Wx24Dx44H

ITEM 3698-6-83 | 72Wx24Dx44H

**OPTIONAL ACCESSORIES**

ITEM 3698-4-83SHELF | 48" Accessory Top Shelf

ITEM 3698-6-83SHELF | 72" Accessory Top Shelf



Please visit [www.calmil.com/legal](http://www.calmil.com/legal) for a complete list of California Proposition 65 related items.



# MADERA collection



A



B



C



D

## A. MADERA SLANTED DISPLAY CASES

Includes 3 – 13" x 18" Clear Trays.  
Available in Attendant and Self Serve.

ITEM 3432-99 | Attendant Serve | 21Wx21½Dx21½H

ITEM 3432-S-99 | Self-Serve | 21Wx21½Dx21½H

ITEM 3047 | Chalkboard Tents

ITEM 325-13-12 | Replacement Tray

## C. MADERA PASTRY DRAWERS

Sold Individually.  
Liner Included. Stackable.

ITEM 3416 | 22Wx14½Dx7½H

## B. MADERA CHAFER

Features Easy Access Drawer for Chafer Fuel.

ITEM 3429-99 | 22Wx14¼Dx12H

## D. MADERA ACRYLIC BEVERAGE DISPENSER

Includes Ice Chamber and Drip Tray.  
3 Gallon Capacity.

ITEM 1527-3-99 | 8½Wx8½Dx26¾H | Ice

ITEM 1527-3INF-99 | 8½Wx8½Dx26¾H | Infusion

Please visit [www.calmil.com/legal](http://www.calmil.com/legal) for a complete list of California Proposition 65 related items.



# MADERA collection



A FRESH TAKE ON FARM TO TABLE, this collection features one-of-a-kind rustic pine wood as its inspiration. The Madera Collection contains a perfect assortment of products that assist in creating a stunning and eye-catching presentation, while offering an environmentally friendly solution.



# MADERA collection

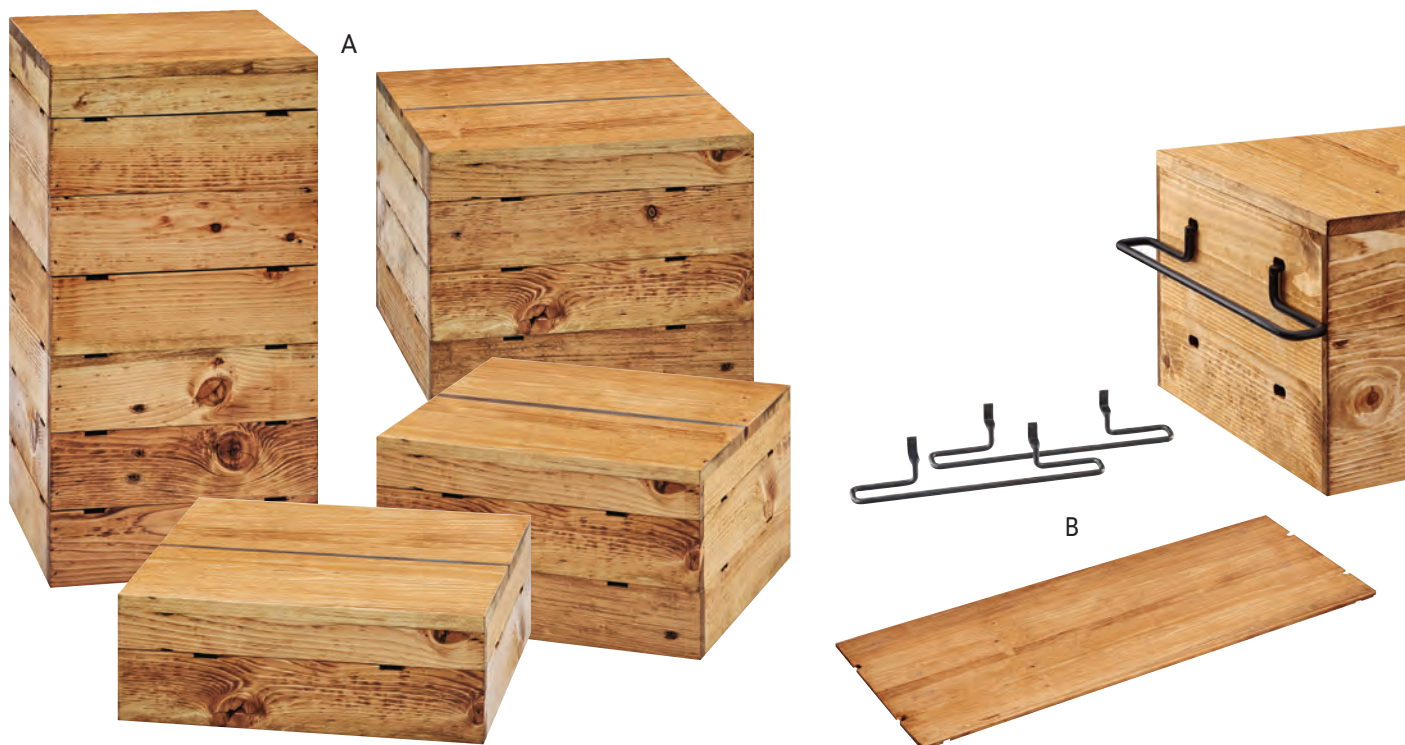

## A. MADERA RISERS

Each Riser Features Slots for Brackets to Position Shelves at Desired Height.

ITEM 3627-99 | 9Wx9Dx18H

ITEM 3628-4-99 | 12Wx12Dx4H

ITEM 3628-7-99 | 12Wx12Dx7H

ITEM 3628-10-99 | 12Wx12Dx10H

## B. NOTCHED SHELVES & BRACKETS

ITEM 1435-1224-99 | 24Wx12Dx1/2H

ITEM 1435-1232-99 | 32Wx12Dx1/2H

ITEM 1435-1248-99 | 48Wx12Dx1/2H

### BRACKETS

ITEM 3723-13 | Pair of Black Brackets | 13Wx2 1/4H



Please visit [www.calmil.com/legal](http://www.calmil.com/legal) for a complete list of California Proposition 65 related items.

**C. MADERA ANGLED RISERS NEW**

- ITEM 22029-3-99 | 7Wx20Dx3H
- ITEM 22029-7-99 | 7Wx20Dx7H
- ITEM 22029-11-99 | 7Wx20Dx11H



**D. MADERA ROUND RISERS NEW**

- ITEM 22050-3-99 | 12DIAx3H
- ITEM 22050-6-99 | 12DIAx6H
- ITEM 22050-9-99 | 12DIAx9H



**E. MADERA SQUARE RISERS NEW**

- ITEM 22065-3-99 | 12Wx12Dx3H
- ITEM 22065-6-99 | 12Wx12Dx6H
- ITEM 22065-9-99 | 12Wx12Dx9H



**F. MADERA ROUND RISERS**

- ITEM 3668-3-99 | 12DIAx3½H
- ITEM 3668-6-99 | 12DIAx6½H
- ITEM 3668-9-99 | 12DIAx9½H

**G. MADERA RECTANGLE RISERS NEW**

- ITEM 22066-3-99 | 7Wx20Dx3H
- ITEM 22066-6-99 | 7Wx20Dx6H
- ITEM 22066-9-99 | 7Wx20Dx9H



Please visit [www.calmil.com/legal](http://www.calmil.com/legal) for a complete list of California Proposition 65 related items.



# MADERA collection



## A. MADERA TABLETOP RISERS

Fold Down Flat For Storage!

ITEM 3620-5-99 | 10Wx10Dx5H

ITEM 3620-8-99 | 10Wx10Dx7¾H

ITEM 3620-11-99 | 10Wx10Dx10¾H

## B. MADERA HEXAGON RISERS

ITEM 435-5-99 | 12DIAx5H

ITEM 435-8-99 | 12DIAx8H

ITEM 435-11-99 | 12DIAx11H



## C. MADERA RECTANGULAR RISERS

ITEM 166-3-99 | 20½Wx7Dx3¼H

ITEM 166-7-99 | 20½Wx7Dx7H

ITEM 166-11-99 | 20½Wx7Dx11H

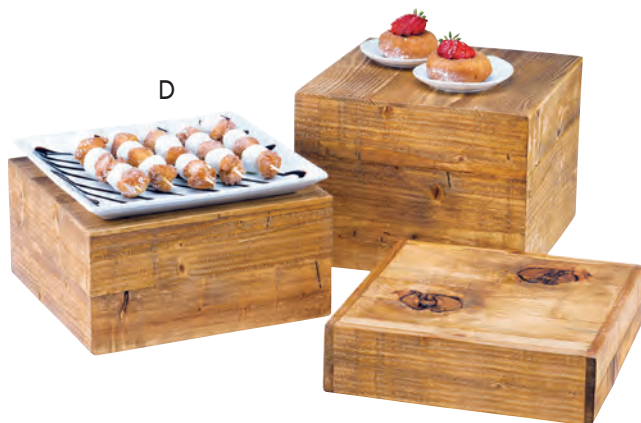

## D. MADERA CUBE RISERS

ITEM 432-3-99 | 12Wx12Dx3¼H

ITEM 432-6-99 | 12Wx12Dx6H

ITEM 432-9-99 | 12Wx12Dx9H



## E. MADERA CAKE STANDS **NEW**

Covers Sold Separately.

ITEM 4310-5-99 | 12¾DIAx5H

ITEM 4310-7-99 | 12¾DIAx7H

ITEM 4310-9-99 | 12¾DIAx9H

ITEM P311 | 12DIAx9H | Cover in Image Above

Please visit [www.calmil.com/legal](http://www.calmil.com/legal) for a complete list of California Proposition 65 related items.



F

22062-99 Pictured with  
3 each Bagel Sleeves  
22061-15



**F. WRITE-ON BAGEL DISPLAY NEW**

Available in Madera (99), White (15).  
Bagel Sleeves Sold Separately.

ITEM 22062-99 | 15Wx16Dx4¼H

ITEM 22062-15 | 15Wx16Dx4¼H

ITEM 22061-13 | Black Bagel Sleeve

ITEM 22061-15 | White Bagel Sleeve

G



**G. MADERA INDUSTRIAL RISER**

Ships Flat, Some Assembly Required.

ITEM 3473-99 | 24Wx10Dx12H

H



**H. MADERA CLIPBOARD MENU**

ITEM 2036-32-99 | 3Wx2H | Card Size

ITEM 2036-46-99 | 4Wx6H | Card Size

ITEM 2036-811-99 | 8½Wx11 | Card Size



I

**I. MADERA 3 TIER RISER DISPLAY**

Ships Flat, Some Assembly Required.

ITEM 3428-99 | 20¾Wx20¾Dx20H

J



**J. CHALKBOARD BOWLS & COLD BOWLS**

ITEM 3593-8-99 | 8Wx8Dx4H

ITEM 3593-10-99 | 10Wx10Dx5H

ITEM 3593-12-99 | 12Wx12Dx6H

STAINLESS STEEL COLD BOWLS ❄️

ITEM 3326-7-55 | Fits 3593-8-99

ITEM 3326-10-55 | Fits 3593-12-99



K



**K. MADERA COLD CONCEPT**

Pieces Sold Separately.

ITEM 3367-99 | 12Wx12Dx5¾H | Base

STAINLESS STEEL COLD BOWL ❄️

ITEM 3326-10-55 | 10Wx10Dx4H



Please visit [www.calmil.com/legal](http://www.calmil.com/legal) for a complete list of California Proposition 65 related items.



# MADERA collection



A

**A. MADERA CARVING STATION**  
Includes Fiber Resin Cutting Board.  
ITEM 3683-99 | 22½Wx18¼Dx4½H



B

**B. MADERA MERCHANDISERS**  
ITEM 3685-99 | 16½Wx6½Dx3¼H  
ITEM 3684-99 | 22½Wx7¾Dx2¼H

**C. 4 SECTION TABLE CADDY**  
ITEM 3692-99 | 9¾Wx8Dx7½H

**D. 6 SECTION TABLE CADDY**  
ITEM 3691-99 | 10¼Wx5Dx5½H

**E. MADERA INDUSTRIAL RISERS**  
3562-3-99 | 8Wx8Dx3½H  
3562-7-99 | 8Wx8Dx7½H  
3562-11-99 | 8Wx8Dx11¼H



C



D

**F. MADERA TRAY WITH HANDLES**  
ITEM 3454-1014-99 | 17¼Wx12½Dx5¼H  
ITEM 3454-1220-99 | 23¼Wx14½Dx5¼H



E



F

Please visit [www.calmil.com/legal](http://www.calmil.com/legal) for a complete list of California Proposition 65 related items.

**G. MADERA ROUND BEVERAGE DISPENSER NEW**

3 Gallon Capacity.  
Includes Chamber and Drip Tray.  
ITEM 4306-3-99 | 10½Dx24H | Ice  
ITEM 4306-3INF-99 | 10½Dx24H | Infusion

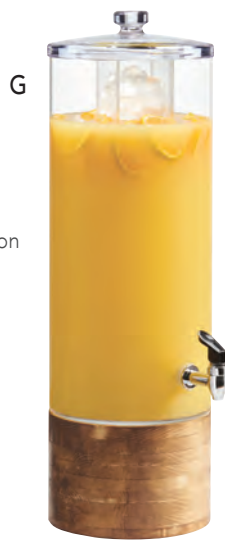

**H. GLASS BEVERAGE DISPENSERS**

2 Gallon Capacity.  
Includes Glass Dispenser, Base, and Chamber.  
ITEM 3422-2 | 10¾Wx11½Dx22¾H  
ITEM 3422-2INF | 10¾Wx11½Dx22¾H

**I. MADERA ACRYLIC BEVERAGE DISPENSER**

3 Gallon Capacity.  
Includes Drip Tray and Chamber.  
ITEM 3561-3-99 | 8Wx8Dx25½H  
ITEM 3561-3INF-99 | 8Wx8Dx25½H

**J. MADERA PORCELAIN BEVERAGE DISPENSER**

Base and Dispenser Sold Separately.  
Chalkboard Sign Included with Dispenser.  
ITEM 3460-1BEV | 1.5 Gallon Dispenser  
ITEM 432-6-99 | 12Wx12Dx6H Wood Base



**K. MADERA CONDIMENT STATION**

Pieces Sold Separately.  
ITEM 2019-99 | 15¼Wx14Dx9½H  
ITEM 298-99 | 4½Wx4½Dx8½H | 3 Shown

**L. MADERA DRIP TRAYS**

Drip Trays are Removable for Cleaning.  
ITEM 330-4-99 | 4WX4DX1½H  
ITEM 330-6-99 | 6WX6DX1½H



**M. MADERA SIGNAGE CARDHOLDERS**

ITEM 3483-23-99 | 3½Wx2H | Card Size  
ITEM 3483-46-99 | 4Wx6H | Card Size  
ITEM 3483-811-99 | 8½Wx11H | Card Size

**CHALKBOARDS**

ITEM 3489-23-99 | 3½Wx2H | Chalkboard Size  
ITEM 3489-46-99 | 4Wx6H | Chalkboard Size  
ITEM 3489-811-99 | 8½Wx11H | Chalkboard Size



Please visit [www.calmil.com/legal](http://www.calmil.com/legal) for a complete list of California Proposition 65 related items.



# MADERA collection



A



B

**A. MADERA VERTICAL CYLINDER DISPLAY**  
Cylinders Sold Separately.

ITEM 3411-99 | 7¼Wx7¾Dx20½H

**B. MADERA CYLINDER STAND**

Use for Flatware or Condiments!  
Cylinders Sold Separately.

ITEM 1425-3-99 | 16Wx5¾Dx6H

**C. MADERA SLANTED CYLINDER STAND**

Cylinders Sold Separately.

ITEM 3423-3-99 | 6¼Wx14½Dx15H

**OPTIONAL CYLINDERS**

Available in Six Colors.

Stainless Steel Style: Perforated (39), (SOLID).  
Colored Melamine: Black (13), White (15),  
Butter Yellow (61), Terra Cotta (62), Sage (63),  
Cranberry (64). Extra Deep: White (8-15).

ITEM 1017-39 | 4½DIAx5½H

ITEM 1017-SOLID | 4½DIAx5½H

ITEM 1017 | 4½DIAx5½H

ITEM 1017-8-15 | 4½DIAx8H | Extra Deep



C



D

**D. MADERA CUP, LID, & STRAW HOLDER**

Fits Cups and Lids up to 3.75" Diameter.

ITEM 2051-99 | 5½Wx19¾Dx20H



E

**E. MADERA REVOLVING  
CUP AND LID ORGANIZER**

Fits Cups and Lids up to 3.75" Diameter.

ITEM 378-99 | 9Wx9Dx18½H



F

**F. MADERA NAPKIN,  
CUP, OR LID ORGANIZER**

Fits Cups and Lids up to 3.75" Diameter.  
Two Shown, Sold Individually.

ITEM 298-99 | 4½Wx4½Dx8½H

Please visit [www.calmil.com/legal](http://www.calmil.com/legal) for a complete list of California Proposition 65 related items.



**G. MADERA CEREAL DISPENSERS**

Specify Mechanism & Liter Capacity.

**4.5 LITER (PER CYLINDER) TURN & SERVE**

ITEM 3584-1-99 | 8Wx9½Dx26½H | 1 Cylinder

ITEM 3584-2-99 | 11Wx8¾Dx26½H | 2 Cylinders

ITEM 3584-3-99 | 19¼Wx9¾Dx26½H | 3 Cylinders

**5 LITER (PER CYLINDER) FREE FLOW**

ITEM 3576-1-99FF | 8Wx9½Dx26½H | 1 Cylinder

ITEM 3576-2-99FF | 11Wx8¾Dx26½H | 2 Cylinders

ITEM 3576-3-99FF | 19¼Wx9¾Dx26½H | 3 Cylinders

**H. MADERA INDUCTION COOKTOP BURNER**

ITEM 3633-99 | 12¾Wx16Dx7¼H

**I. MADERA BUTANE BURNER STOVE FRAME**

Optional Butane Stove Sold Separately.

ITEM 3435-99 | 12¾Wx14¾Dx6½H

ITEM 4010-I | Optional Butane Stove

**J. MADERA INDUCTION BURNER ACTION STATION**

All Pieces Sold Separately.

Jar Holders and 1/6 Pan Holders

Include Cold Pucks.

Jars and Pans Included.

ITEM 3633-99 | 12¾Wx16Dx7¼H

ITEM 3836-3-99 | 15¾Wx5½Dx8¾H

ITEM 3837-3-99 | 11¾Wx7¾Dx6¼H

**K. MADERA CHAFER ALTERNATIVES**

ITEM 3440-99 | 10¼Wx10Dx5½H

ITEM 3439-99 | 19¾Wx10Dx5¾H



Please visit [www.calmil.com/legal](http://www.calmil.com/legal) for a complete list of California Proposition 65 related items.



# MADERA collection



A

B



C



D



E

## A. MADERA paneled BAKERY CASE

Includes 3 – 13" x 18" Clear Trays.

ITEM 3621-99 | 25Wx17Dx23H

ITEM 325-13-12 | Replacement Tray

## B. MADERA BREAD DISPLAY

Includes 3 Clear Drawers.

Can be Used Vertically or Horizontally.

ITEM 1204-99 | 8Wx13Dx20½H

ITEM 1204DRAWER | Replacement Bin

## C. MADERA BREAD DISPLAY

ITEM 3624-99 | 20¼Wx12¾Dx13¼H

## D. MADERA CAKE PEDESTAL

Platter and Cover Sold Separately.

ITEM 3481-99 | 13½DIAx4½H - Pedestal

ITEM 3488 | 12DIAx8½H - Bell Cover

ITEM PP1167 | 12¾DIA Porcelain Platter

## E. MADERA ICE HOUSINGS

Includes Clear Polycarbonate Pans.

ITEM 3360-6 | 7¾Wx7Dx7H

ITEM 3360-10 | 13Wx11Dx6½H

ITEM 3360-12 | 21½Wx12½Dx6H

Please visit [www.calmil.com/legal](http://www.calmil.com/legal) for a complete list of California Proposition 65 related items.

**F. MADERA  
SINGLE BREAD DRAWER**  
ITEM 4200-1-99 | 7½Wx13Dx6¾H

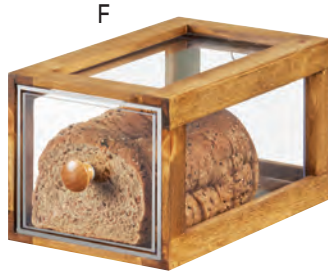

**G. MADERA 2 BIN  
BREAD DRAWER**  
ITEM 4200-2-99 | 13¾Wx13Dx7¼H



**H. MADERA 2 TIER DISPLAY CASE**  
Attendant Serve Only.  
ITEM 3832-99 | 11½Wx12¼Dx12½H



**I. ALUMINUM COLD CONCEPT**  
Wood Frames Include Cold Pack and Liner.  
Aluminum Platter Sold Separately.  
Place Cold Pack in Freezer for a Minimum  
of 6 Hours Keeps Contents Cold for 2-3 Hours.

**WOOD FRAMES** ❄️

ITEM 3699-915-99 | 14½Wx10¼Dx3½H

ITEM 3699-623-99 | 23Wx7¾Dx3½H

ITEM 3699-1123-99 | 23Wx12½Dx3½H

**ALUMINUM PLATTERS**

ITEM 3672-915 | 15½Wx9½Dx1½H

ITEM 3672-623 | 23½Wx6½Dx1½H

ITEM 3672-1123 | 23½Wx11½Dx1½H

**J. MADERA  
COLD CONCEPT TRAY **NEW****  
Madera Frame Sold Separately.  
Cold Concept Set Includes Cold Packs.  
ITEM 22071 | 8¾Wx16¾DX1½H | Cold Set  
ITEM 22072-99 | 9¾Wx17¾DX1¾H | Frame



22071 and 22072-99



22071

**K. MADERA FLATWARE DISPLAY**  
Flatware Insert is Removable  
for Cleaning.  
ITEM 3408-99 | 9Wx6Dx5¼H



**L. MADERA CARAFE COOLERS **NEW****  
Includes Cold Packs.  
ITEM 22081-99 | 5¾Wx7½DX7H | Fits 3551-55  
ITEM 22082-99 | 5¼Wx14½DX7H | Fits 3614-55  
ITEM 3551-55 | 4DIAx13H | 1½ Liter  
ITEM 3614-55 | 4DIAx10H | 1 Liter



22081-99



22082-99

Please visit [www.calmil.com/legal](http://www.calmil.com/legal) for a complete list of California Proposition 65 related items.



# MADERA collection



A



B



C

**A. MADERA CONDIMENT ORGANIZER**  
ITEM 796-99 | 9Wx6¼Dx4½H

**B. MADERA CONDIMENT CADDY**  
ITEM 3398-99 | 8¾Wx6Dx3¼H

**C. MADERA STIR-STICK ORGANIZER**  
ITEM 3308-99 | 5¼Wx5¼Dx5½H



D

**D. MADERA SINGLE JAR RISERS**  
Includes Glass Jar.  
ITEM 3427-3-99 | 4½Wx4½Dx3H  
ITEM 3427-5-99 | 4½Wx4½Dx5H  
ITEM 3427-7-99 | 4½Wx4½Dx7H  
ITEM C4X4GLCN | Replacement Glass Jar



E

**E. MADERA JAR ORGANIZERS**  
Includes Glass Jars.  
ITEM 3714-99 | 13½Wx4½Dx4¾H | w/ 3 Jars  
ITEM 3713-99 | 13½Wx8½Dx5H | w/ 6 Jars

G

**F. MADERA JAR DISPLAYS**  
Includes 3 Glass Jars.  
Chalkboard Stick-On's Sold Separately.  
ITEM 3406-3 | 14Wx5½Dx3H  
ITEM 3406-6 | 14Wx5½Dx6H  
**OPTIONAL CHALKBOARD  
STICK-ON AND PENS**  
ITEM 3057 | 3Wx2D Stick-On  
ITEM 3062-15 | White Chalkboard Pen



F



**G. MADERA PLATE  
NAPKIN HOLDER **NEW****  
Fits 10" Plates and 4"x8" Napkins.  
ITEM 22068-99 | 10¼Wx15Dx8¼H

Please visit [www.calmil.com/legal](http://www.calmil.com/legal) for a complete list of California Proposition 65 related items.



H. MADERA CONDIMENT ORGANIZERS

ITEM 2053-99 | 6Wx7Dx16H

ITEM 2054-99 | 11Wx7Dx16H



I. MADERA SLANTED ORGANIZER

Middle Shelf is Removable to Create More Space.

ITEM 2052-99 | 6Wx13Dx15H



J. MADERA TABLE CADDY

ITEM 3669-99 | 15¾Wx5Dx2½H



K. MADERA BAR ORGANIZER

ITEM 3499-99 | 10¾Wx7Dx4¾H



L. MADERA ORGANIZER CADDY

Includes 3 Clear Inserts.

ITEM 3613-3-99 | 13¾Wx10Dx5¼H



M. MADERA MULTI-SECTION ORGANIZER

ITEM 1714-99 | 12Wx12Dx5½H



N. MADERA ADJUSTABLE CONDIMENT HOLDER **NEW**

Easily Change Depth to Better Show Condiments.

ITEM 22096-99 | 7½Wx7½Dx7H

Please visit [www.calmil.com/legal](http://www.calmil.com/legal) for a complete list of California Proposition 65 related items.



# MADERA collection



A



B



C



D



E



F

A. MADERA 3 TIER SHELF RISER  
ITEM 3637-99 | 24Wx12¼Dx24H

B. MADERA SERVING TRAYS **NEW**  
Includes Removable Acrylic.  
Easily Customize Any Event!  
ITEM 22049-1212-99 | 12Wx12Dx1H  
ITEM 22049-208-99 | 20Wx8Dx1H

C. MADERA SERVING TRAY  
ITEM 3924-99 | 17¼Wx12¼Dx5H

D. MADERA 12X12 SERVING TRAY  
ITEM 3701-99 | 12Wx12Dx3½H

E. MADERA SALAD STATION  
Includes Liner and 5 Pan Inserts.  
ITEM 3585-99 | 21½Wx12½Dx6H

F. MADERA COFFEE  
SLEEVE DISPENSER  
ITEM 2050-99 | 6¼Wx12¼Dx4½H

Please visit [www.calmil.com/legal](http://www.calmil.com/legal) for a complete list of California Proposition 65 related items.



**G. MADERA STACKING BOXES**

- ITEM 3682-55-99 | 5Wx5Dx3¼H
- ITEM 3682-125-99 | 12Wx5Dx3¼H
- ITEM 3682-1210-99 | 12Wx10Dx3¼H
- ITEM 3682-205-99 | 20Wx5Dx3¼H
- ITEM 3682-2012-99 | 20Wx12Dx3¼H

**H. MADERA WRITE-ON TENT NEW**

- Write-On Both Sides.
- ITEM 22051-99 | 2Wx2¼Dx3H

**I. MADERA RESTAURANT CARD HOLDER**

- ITEM 3734-99 | 2¾Wx2¾Dx4H

**J. MADERA MERCHANDISER**

- ITEM 3448-99 | 16½Wx15½Dx12H

**K. MADERA CYLINDER TRAYS**

- Includes 3 Melamine Cylinders.
- ITEM 3647-16-99 | 13Wx4½Dx4½H | 16 oz. Jars
- ITEM 3647-32-99 | 16Wx5½Dx6H | 32 oz. Jars



Please visit [www.calmil.com/legal](http://www.calmil.com/legal) for a complete list of California Proposition 65 related items.



# MADERA collection



A



B

**A. MADERA MERCHANDISERS**  
Shelves Adjustable to Sit Straight or Slanted.  
ITEM 3494-2-99 | 12Wx12Dx21H  
ITEM 3494-3-99 | 12Wx12Dx31H



C

**B. CHALKBOARD MERCHANDISER**  
ITEM 3607-13 | 15Wx14Dx19H  
ITEM 3062-15 | White Chalkboard Pen

**C. MISSION 2 TIER STAND**  
Stand Only.  
12x20 Bins and Trays Sold Separately.  
ITEM 1722 | 23Wx13Dx15H



D

**D. MADERA BIN & TRAYS**  
3474 and 1367-10-99 Do Not Fit Stands.  
TRAYS

ITEM 3474-99 | 12Wx13Dx1½H  
ITEM 1367-10-99 | 12Wx9¼Dx1¼H  
ITEM 1367-12-99 | 19¼Wx11¼Dx1¼H  
BIN W/ COVER  
ITEM 1332-12-99 | 20Wx11Dx6½H  
ITEM 1332-12-INSERT | Liner



E

**E. BLACK IRON STAND**  
Frame Only, 12x20 Trays Sold Separately.  
ITEM 1330-12-13 | 26¼Wx12½Dx27½H

Please visit [www.calmil.com/legal](http://www.calmil.com/legal) for a complete list of California Proposition 65 related items.



F. MADERA ROUND MERCHANDISER **NEW**  
ITEM 22063-99 | 13¼DIAx18½H



G. MADERA SERVING CART **NEW**  
Accessories Sold Separately.  
Ships by Truck Only.  
ITEM 22123-99 | 48Wx18Dx70½H

H. MADERA CUP STACKING RACK **NEW**  
ITEM 22041-99 | 23¼Wx14½Dx12H

I. MADERA CEREAL DISPENSERS  
600 Cubic Inch Capacity Per Bin.  
ITEM 22067-1-99 | 6½Wx9¼Dx24¼H **NEW**  
ITEM 3434-99 | 18Wx14½Dx24H



H



I

Please visit [www.calmil.com/legal](http://www.calmil.com/legal) for a complete list of California Proposition 65 related items.



# SIERRA collection



**A. SIERRA BEVERAGE DISPENSERS**  
 3 Gallon Capacity.  
 Includes Chamber and Drip Tray.  
 ITEM 3906-3-84 | 8¾Wx8¾Dx24H | Ice  
 ITEM 3906-3INF-84 | 8¾Wx8¾Dx24H | Infusion

**B. SIERRA MERCHANDISER CART**  
 ITEM 3921-84 | 14¾Wx14¾Dx35H

**C. SIERRA BREAD DISPLAY**  
 ITEM 3908-84 | 22½Wx14¾Dx13¾H

**D. SIERRA CHAFER**  
 Features Polished Stainless Steel Cover  
 with Self-Closing Lid.  
 ITEM 3907-84 | 22Wx15Dx14H

Please visit [www.calmil.com/legal](http://www.calmil.com/legal) for a complete list of California Proposition 65 related items.



# SIERRA collection



A BEAUTIFUL COLLABORATION OF METAL AND WOOD, the Sierra Collection creates the perfect ambiance of natural beauty. The warm undertones of the wood blend subtly with vintage bronze-painted metal to bring together a unique, organic display.



# SIERRA collection



A



B



C



8-15 61 62 63 64 15 13 Solid 39



D

**A. SIERRA ICE HOUSINGS**  
Includes Clear Polycarbonate Pan.  
ITEM 3905-10-84 | 13¼Wx11¼Dx6H  
ITEM 3905-12-84 | 21¾Wx13¾Dx6H

**B. SIERRA CYLINDER DISPLAY**  
Cylinders Sold Separately.  
ITEM 3912-84 | 6¾Wx6¾Dx19½H  
**OPTIONAL CYLINDERS**  
Available in Six Colors.  
Stainless Steel Style: Perforated (39), (SOLID).  
Colored Melamine: Black (13), White (15),  
Butter Yellow (61), Terra Cotta (62), Sage (63),  
Cranberry (64). Extra Deep: White (8-15).  
ITEM 1017-39 | 4½DIAx5½H  
ITEM 1017-SOLID | 4½DIAx5½H  
ITEM 1017 | 4½DIAx5½H  
ITEM 1017-8-15 | 4½DIAx8H | Extra Deep

**C. SIERRA REVOLVING  
CUP & LID ORGANIZER**  
Holds Up to 3.75" Diameter Cups & Lids.  
ITEM 3904-84 | 9¼Wx9¼Dx18H

**D. SIERRA JAR DISPLAYS**  
Includes Glass Jars.  
ITEM 3910-3-84 | 13Wx5Dx4¼H | w/ 3 Jars  
ITEM 3910-6-84 | 12½Wx9Dx4½H | w/ 6 Jars  
ITEM C4X4GLCN | Replacement Glass Jar

Please visit [www.calmil.com/legal](http://www.calmil.com/legal) for a complete list of California Proposition 65 related items.



**E. SIERRA LIBRARY DISPLAY**  
 Accessories Sold Separately.  
 ITEM 3903-84 | 38¼Wx13½Dx24H



**F. SIERRA ELEVATION RISER**  
 ITEM 3918-84 | 13½Wx13½Dx25H



**G. SIERRA SQUARE RISERS**  
 ITEM 3902-3-84 | 12Wx12Dx3¼H  
 ITEM 3902-6-84 | 12Wx12Dx6H  
 ITEM 3902-9-84 | 12Wx12Dx9H



**H. SIERRA RECTANGULAR RISERS**  
 ITEM 3901-3-84 | 20½Wx7Dx3¼H  
 ITEM 3901-7-84 | 20½Wx7Dx7H  
 ITEM 3901-11-84 | 20½Wx7Dx11H

Please visit [www.calmil.com/legal](http://www.calmil.com/legal) for a complete list of California Proposition 65 related items.



# SIERRA collection

A



B



**A. SIERRA COMPACT PASTRY DRAWER**  
ITEM 3930-84 | 24Wx24Dx10¼H

C



D

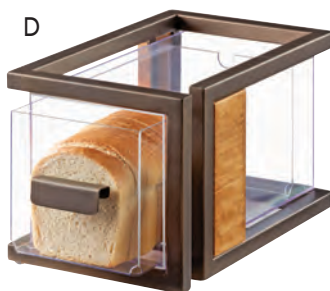

**B. SIERRA PASTRY DRAWER**  
ITEM 3928-84 | 22½Wx14½Dx7½H

**C. SIERRA 2 TIER DISPLAY CASE**  
Available In Self Or Attendant Serve.  
ITEM 3931-84 | 19Wx22Dx18½H  
ITEM 3931-S-84 | 19Wx22Dx18½H

**D. SIERRA SINGLE BREAD DRAWER**  
ITEM 3927-84 | 8Wx12¾Dx8H

E



**E. SIERRA MERCHANDISERS**  
ITEM 3494-2-84 | 12Wx12Dx21H  
ITEM 3494-3-84 | 12Wx12Dx31H

**F. SIERRA ANGLED MERCHANDISER**  
ITEM 3448-84 | 15¾Wx17Dx13H

F

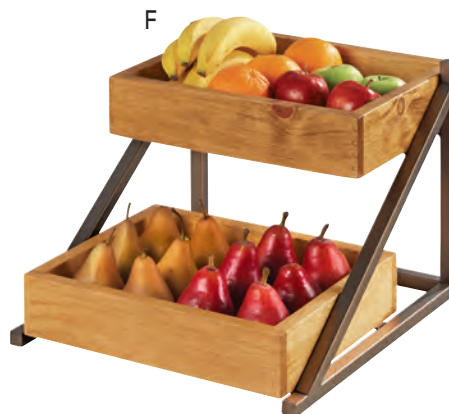

Please visit [www.calmil.com/legal](http://www.calmil.com/legal) for a complete list of California Proposition 65 related items.

**G. SIERRA SLANTED CYLINDER HOLDER**

Cylinders Sold Separately.

ITEM 3423-3-84 | 7Wx14½Dx15H

**OPTIONAL CYLINDERS**

Available in Six Colors.

Stainless Steel Style: Perforated (39), (SOLID).  
Colored Melamine: Black (13), White (15),  
Butter Yellow (61), Terra Cotta (62), Sage (63),  
Cranberry (64). Extra Deep: White (8-15).

ITEM 1017-39 | 4½DIAx5½H

ITEM 1017-SOLID | 4½DIAx5½H

ITEM 1017 | 4½DIAx5½H

ITEM 1017-8-15 | 4½DIAx8H | Extra Deep



**H. SIERRA CEREAL DISPENSER**

Features Pull & Serve Mechanism.

600 Cubic Inch Capacity Per Bin.

ITEM 3909-84 | 18Wx10Dx24H



**I. SIERRA CUP & LID HOLDER**

Holds Up to 3.75" Diameter Cups & Lids.

ITEM 3900-84 | 4¾Wx4¾Dx8¼H



**J. SIERRA CHAFER ALTERNATIVES**

ITEM 3916-84 | 10¼Wx10Dx7¼H

ITEM 3917-84 | 19¾Wx10Dx7¼H

**K. SIERRA ACCENT BOWL**

ITEM 3911-10-84 | 10DIAx6H





# SIERRA collection

A



B



C



**A. SIERRA PASTRY DRAWER**

Sold Individually.

ITEM 3694-84 | 48Wx24Dx10H

**B. SIERRA SQUARE BAKERY CASE**

ITEM 3610 | 21Wx17Dx23¼H

**C. SIERRA DISPLAY CASE**

Sliding Doors in Back for Attendant or Self-Serve! Serving Trays & Plates Not Included.

ITEM 3695-84 | 42Wx17Dx23H

D



**D. SIERRA SLIDING DOOR CASES**

Serving Trays & Plates Not Included.

ITEM 3611 | 36Wx19½Dx17¼H | Attendant

ITEM 3611-S | 36Wx19½Dx17¼H | Self Serve

Please visit [www.calmil.com/legal](http://www.calmil.com/legal) for a complete list of California Proposition 65 related items.

**E. SIERRA DUAL DRAWER DISPLAY**  
Includes Liners.  
Drawers Pull Out From Opposite Sides.  
ITEM 3920-84 | 21¾Wx15½Dx11½H



**F. SIERRA 3 JAR TIERED DISPLAY **NEW****  
Includes Glass Jars.  
ITEM 4304-84 | 5Wx12¾Dx8H  
ITEM C4X4GLCN | Replacement Glass Jar  
**COLD CONCEPT FOR GLASS JARS**  
Sold Separately.  
ITEM 22112 | 3¾Wx3¾Dx1H



**G. SIERRA CARDHOLDERS**  
ITEM 3925-46-84 | 4Wx6H  
ITEM 3925-811-84 | 8½Wx11H

**H. SIERRA CHALKBOARD SIGNS**  
ITEM 3919-43-84 | 4Wx3H  
ITEM 3919-46-84 | 4Wx6H  
ITEM 3919-811-84 | 8½Wx11H  
ITEM 3062-15 | White Chalkboard Pen

**I. SIERRA SLANTED CUP, LID, AND STRAW HOLDER**  
ITEM 2051-84 | 6Wx16¾Dx16¼H



Please visit [www.calmil.com/legal](http://www.calmil.com/legal) for a complete list of California Proposition 65 related items.



# SIERRA collection



3698-6-84 Shown  
with Optional  
Accessory  
Top Shelf  
3698-6-84SHELF.



## A. SIERRA U-BUILD CART

Cart Includes 3 Large Shelves, Support Beams, and Wheels. Small Accessory Top Shelf (Pictured) Sold Separately.

ITEM 3698-4-84 | 48Wx24Dx44H | Cart

ITEM 3698-6-84 | 72Wx24Dx44H | Cart

### OPTIONAL ACCESSORIES

ITEM 3698-4-84SHELF | 4' Accessory Top Shelf

ITEM 3698-6-84SHELF | 6' Accessory Top Shelf

ITEM 3698-BRACKET | Bronze Bracket



Optional Bronze Brackets  
Sold Separately.

## B. SIERRA BEVERAGE CART

Accessories Sold Separately.

ITEM 3913-84 | 36Wx17½Dx39H

Please visit [www.calmil.com/legal](http://www.calmil.com/legal) for a complete list of California Proposition 65 related items.



**C. SIERRA MODULAR CART NEW**  
 U-Build Cart Includes 3 Wood Shelves, Locking  
 Wheels, and Brackets.  
 Accessories Sold Separately.  
 ITEM 22101-99 | 72Wx24Dx44H



**D. ACCESSORY ACTION  
 STATION SHELF NEW**  
 Shelf Includes Removeable Inserts for 2 Induction  
 Units and Cold Well.  
 ITEM 22102-99 | 72Wx24Dx1½H

- OPTIONAL ACCESSORIES**  
 ITEM 3633-COOKTOP | Optional Induction Stove  
 ITEM 22104-55 | Cold Well With Condensation Liner  
**MELAMINE INSERTS FOR COLD WELL**  
 ITEM 22120-15 | 6¾Wx6¼Dx3¾H | 1/6 Pan  
 ITEM 22121-15 | 12½Wx6¾Dx3¾H | 1/3 Pan  
 ITEM 22122-15 | 12½Wx10¼Dx3¾H | 1/2 Pan



**E. ACCESSORY ACTION  
 STATION PANELS NEW**  
 Panels Attached by Magnets. Attendant Side  
 Remains Uncovered.  
 ITEM 22103 | 6 Separate Panels

Please visit [www.calmil.com/legal](http://www.calmil.com/legal) for a complete list of California Proposition 65 related items.



# MID-CENTURY collection



A



B



C



D

**A. MID-CENTURY BEVERAGE DISPENSERS**  
3 Gallon Capacity. Includes Drip Tray and Chamber.  
Specify Color: Brass (46), Chrome (49).  
ITEM 3703-3 | 8¼Wx10Dx24H  
ITEM 3703-3INF | 8¼Wx10Dx24H

**B. MID-CENTURY CHAFERS**  
Features Easy Access Drawer for Chafer Fuel.  
Includes Polished Stainless Steel Cover  
with Self-Closing Lid.  
Specify Color: Brass (46), Chrome (49).  
ITEM 3705 | 23Wx17½Dx13¾H

**C. MID-CENTURY PASTRY CASES**  
Includes Marble Melamine Trays.  
Specify Color: Brass (46), Chrome (49).  
ITEM 3706-1511 | 16¼Wx11¼Dx18H  
ITEM 3706-1813 | 19½Wx13½Dx18H

**D. CARRARA MARBLE MELAMINE TRAYS**  
Marble Melamine (81M).  
ITEM 3629-712-81M | 7Wx12Dx¾H  
ITEM 3629-1511-81M | 14¾Wx10¾Dx¾H  
ITEM 3629-1813-81M | 18Wx13Dx¾H  
ITEM 3656-12-81M | 12DIAx¾H  
ITEM 3656-15-81M | 15DIAx¾H

Please visit [www.calmil.com/legal](http://www.calmil.com/legal) for a complete list of California Proposition 65 related items.



# MID-CENTURY collection



A MODERN TAKE ON MID-CENTURY, this collection combines classic walnut wood with accents of brass and chrome. Its timeless design offers a stunning blend of traditional and contemporary materials to create a striking presentation for all gatherings.



# MID-CENTURY collection

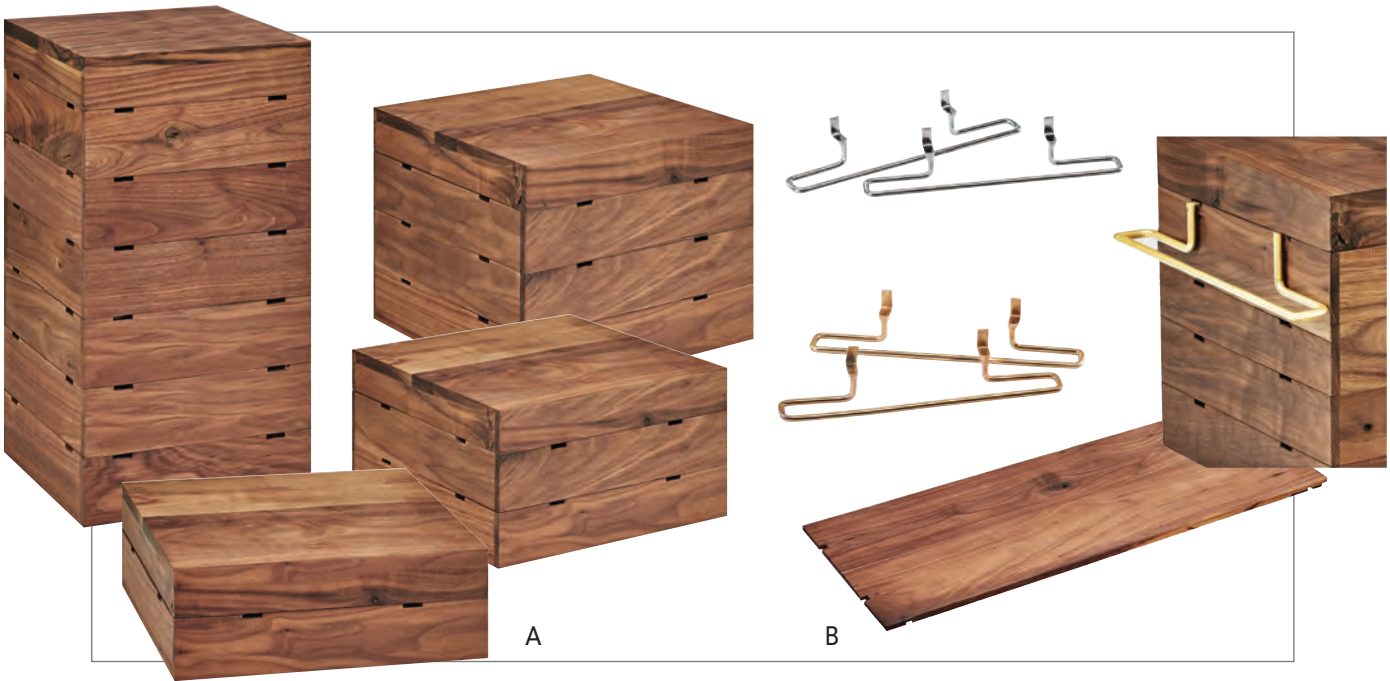

## A. MID-CENTURY RISERS

Each Riser Features Slots for Brackets to Position Shelves at Desired Height. Walnut (78).

ITEM 3627-78 | 9Wx9Dx18H

ITEM 3628-4-78 | 12Wx12Dx4H

ITEM 3628-7-78 | 12Wx12Dx7H

ITEM 3628-10-78 | 12Wx12Dx10H

## B. NOTCHED SHELVES & BRACKETS

Walnut (78).

ITEM 1435-1224-78 | 24Wx12Dx½H

ITEM 1435-1232-78 | 32Wx12Dx½H

ITEM 1435-1248-78 | 48Wx12Dx½H

### BRACKETS

ITEM 3723-46 | Pair of Brass Brackets  
13Wx2½Hx2½D

ITEM 3723-49 | Pair of Chrome Brackets  
13Wx2½Hx2½D



Brass (46)

## C

## C. MID-CENTURY CEREAL DISPENSERS

Features Turn & Serve Mechanism.

4.5 Liter Capacity Per Cylinder.

Specify Color: Brass (46), Chrome (49).

ITEM 3720 | 19½Wx12Dx28½H

## D



4014-78



4012-78



4013-78

## D. MID-CENTURY CARDHOLDERS

ITEM 4012-78 | 1¾Wx1¾Dx1¼H

ITEM 4013-78 | 1¾Wx1¾Dx1¼H

ITEM 4014-78 | 3¼Wx3¼Dx1H

Please visit [www.calmil.com/legal](http://www.calmil.com/legal) for a complete list of California Proposition 65 related items.



E

**E. GLASS BEVERAGE DISPENSER WITH WALNUT BASE**

Includes Glass Dispenser, Base, and Ice Chamber. 2 Gallon Capacity.

ITEM 3568-2-78 | 10¼Wx10¼Dx21H



F

**F. WIRE BEVERAGE DISPENSERS**

3 Gallon Capacity.

Includes Chamber and Drip Tray. Specify Color: Brass (46), Chrome (49).

ITEM 22002-3 | 8¼Wx9¼Dx25¼H | Square

ITEM 22005-3 | 8¼Wx9¼Dx25¼H | Round

**INFUSION CHAMBER**

ITEM 22002-3INF | 8¼Wx9¼Dx25¼H | Square

ITEM 22005-3INF | 8¼Wx9¼Dx25¼H | Round



G

**G. MID-CENTURY BEVERAGE CARTS**

Cart Only. Accessories Sold Separately.

Features Walnut Shelves and Clear Removable Liner. Ships by Truck Only. Specify Color: Brass (46), Chrome (49).

Ships by Truck Only.

ITEM 3719 | 27Wx16Dx36H | Cart

**ACCESSORIES SHOWN**

ITEM 3551-55 | Stainless/Polycarbonate Carafes

ITEM 3718-46 | Mid-Century Brass Napkin Holder

ITEM 3717-811-46 | Mid-Century Brass Easel

Please visit [www.calmil.com/legal](http://www.calmil.com/legal) for a complete list of California Proposition 65 related items.



# MID-CENTURY collection



## A. MID-CENTURY BUTANE STOVE FRAMES

Optional Butane Burner Sold Separately.  
Specify Color: Brass (46), Chrome (49).

ITEM 3712 | 14¼Wx12¾Dx7¼H

ITEM 4010-I | Optional Butane Burner

## B. MID-CENTURY INDUCTION BURNER

Includes Induction Burner.  
Walnut (78).

ITEM 3633-78 | 12¾Wx16Dx7¼H



## C. MID-CENTURY CHAFER ALTERNATIVES

Has Built in Windguards.  
Specify Color: Brass (46), Chrome (49).

ITEM 3711 | 10¼Wx10Dx7½H

ITEM 3722 | 19¾Wx10Dx7½H



## D. MID-CENTURY CONDIMENT ORGANIZERS

Specify Color: Brass (46), Chrome (49).

ITEM 3707 | 12Wx12Dx4½H

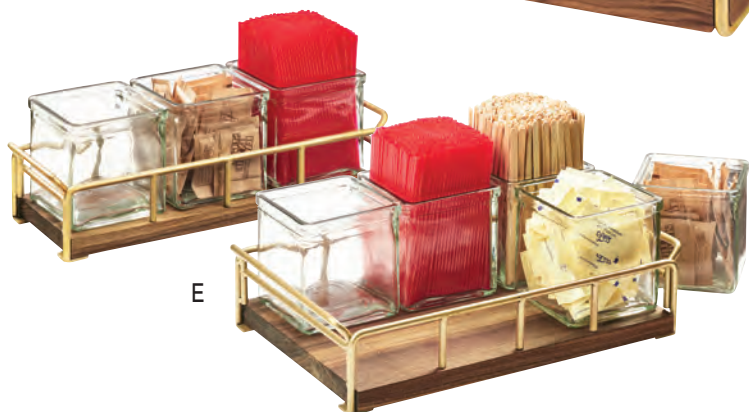

## E. MID-CENTURY JAR ORGANIZERS

Includes Jars.  
Specify Color: Brass (46), Chrome (49).

ITEM 3714 | 13½Wx4½Dx4¾H | w/ 3 Jars

ITEM 3713 | 13½Wx8½Dx5H | w/ 6 Jars

ITEM C4X4GLCN | Replacement Glass Jar

Please visit [www.calmil.com/legal](http://www.calmil.com/legal) for a complete list of California Proposition 65 related items.



F

**F. MID-CENTURY SQUARE RISERS**

Walnut (78).

ITEM 432-3-78 | 12Wx12Dx3¼H

ITEM 432-6-78 | 12Wx12Dx6¼H

ITEM 432-9-78 | 12Wx12Dx9H



G

**G. MID-CENTURY  
RECTANGULAR WALNUT RISERS**

Walnut (78).

ITEM 166-3-78 | 20Wx7Dx3H

ITEM 166-7-78 | 20Wx7Dx7H

ITEM 166-11-78 | 20Wx7Dx11H



H

**H. MID-CENTURY REVERSIBLE RISERS**

Specify Color: Brass (46), Chrome (49).

ITEM 3724 | 20Wx7Dx6H



I

**I. MID-CENTURY FRAME RISERS**

Specify Color: Brass (46), Chrome (49).

Ships by Truck Only.

ITEM 3708 | 32Wx13½Dx25½H

Please visit [www.calmil.com/legal](http://www.calmil.com/legal) for a complete list of California Proposition 65 related items.



# MID-CENTURY collection



**A. MID-CENTURY REVOLVING CUP & LID ORGANIZER**  
 Holds Up to 3.75" Diameter Cups & Lids  
 Specify Color: Brass (46), Chrome (49).  
 3709 | 8¼Wx8¼Dx18H

**B. MID-CENTURY CYLINDER DISPLAY**  
 Cylinders Sold Separately.  
 Specify Color: Brass (46), Chrome (49).  
 3715 | 6½Wx6½Dx19½H

**OPTIONAL CYLINDERS**  
 Available in Six Colors.  
 Stainless Steel Style: Perforated (39), (SOLID).  
 Colored Melamine: Black (13), White (15),  
 Butter Yellow (61), Terra Cotta (62), Sage (63),  
 Cranberry (64). Extra Deep: White (8-15).

ITEM 1017-39 | 4½DIAx5½H  
 ITEM 1017-SOLID | 4½DIAx5½H  
 ITEM 1017 | 4½DIAx5½H  
 ITEM 1017-8-15 | 4½DIAx8H | Extra Deep

**C. MID-CENTURY SINGLE CUP & LID ORGANIZERS**  
 Holds up to 3.75" Diameter Cups & Lids.  
 Specify Color: Brass (46), Chrome (49).  
 ITEM 3716 | 5DIAx8½H

**D. MID-CENTURY EASELS**  
 Specify Color: Brass (46), Chrome (49).  
 ITEM 3717-46 | 4Wx6H | Chalkboard Size  
 ITEM 3717-811 | 8½Wx11H | Chalkboard Size  
 ITEM 3062-15 | White Chalkboard Pen

**E. MID-CENTURY NAPKIN HOLDERS**  
 Dimensions: 10Wx5½Dx3½H.  
 Specify Color: Brass (46), Chrome (49).  
 ITEM 3718 | 4Wx8H | Napkin Size

**F. RESIN MARBLE CYLINDERS**  
 ITEM 3589-34 | 2¾DIAx4½H  
 ITEM 3589-45 | 4¾DIAx5½H

**G. MID-CENTURY SINGLE-POLE BAGEL HOLDER **NEW****  
 ITEM 22128-49 | 5¾Wx5¾Dx6½H

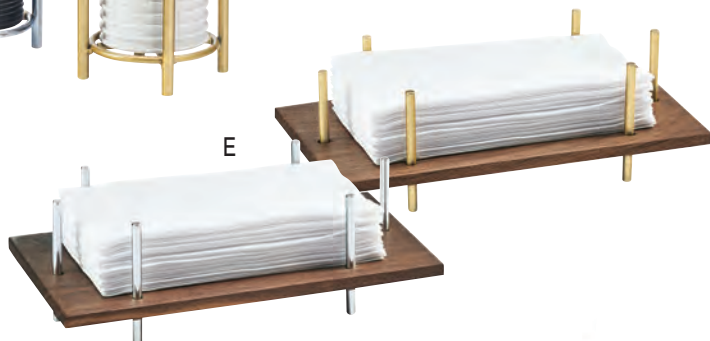
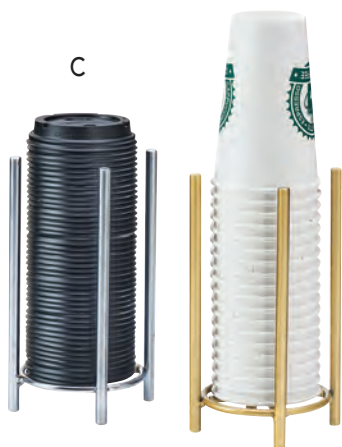

Please visit [www.calmil.com/legal](http://www.calmil.com/legal) for a complete list of California Proposition 65 related items.



**H. MID-CENTURY MERCHANDISERS**  
 Shelves Adjustable to Sit Straight or Slanted.  
 Specify Color:  
 Brass (46), Chrome (49).  
 ITEM 3704-2 | 13Wx12Dx16½H  
 ITEM 3704-3 | 13Wx12Dx26H



**I. MID-CENTURY FLATWARE ORGANIZERS**  
 Specify Color:  
 Brass (46), Chrome (49).  
 ITEM 3700 | 9½Wx6½Dx5½H



**J. WHITE PEDESTAL**  
 Constructed of Resin.  
 ITEM 3588-15 | 12DIAx3H



**K. MID-CENTURY ICE HOUSINGS**  
 Includes Clear Polycarbonate Pan.  
 Specify Color:  
 Brass (46), Chrome (49).  
 ITEM 3702-6 | 7¾Wx7Dx7¼H  
 ITEM 3702-10 | 13¾Wx11¼Dx7¼H  
 ITEM 3702-12 | 21¾Wx13½Dx7¼H



# BAMBOO collection



A



B

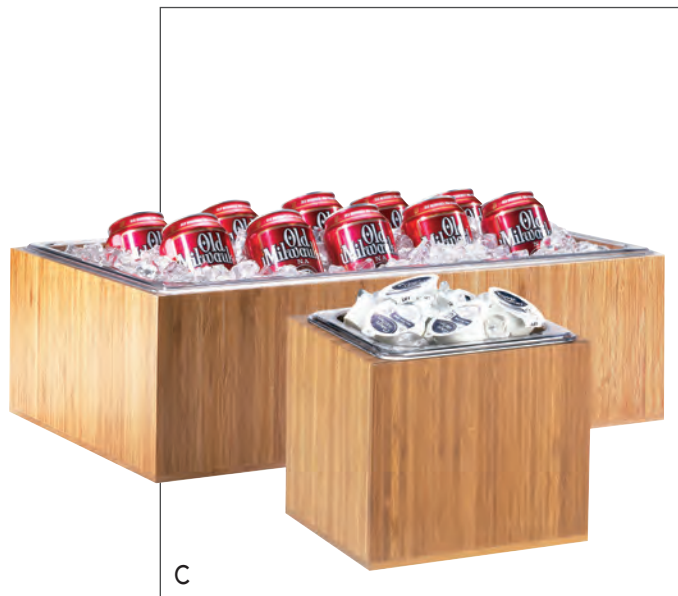

C



D

**A. BAMBOO CONDIMENT STATION**  
Stand Only. Cocks and Jars Sold Separately.

ITEM 3638-60 | 14½Wx13Dx12¼H

**OPTIONAL JARS & CROCKS**

- ITEM 1950-16-13 | Round Black Melamine Crock
- ITEM 1950-16-15 | Round White Melamine Crock
- ITEM C4X4GLCN | Square Glass Jar
- ITEM C4X4-60 | Square Bamboo Bin

**C. BAMBOO ICE HOUSINGS**  
Includes Clear Polycarbonate Pan.

- ITEM 475-6-60 | 6Wx7Dx6½H
- ITEM 475-10-60 | 10Wx12Dx6½H
- ITEM 475-12-60 | 12Wx20Dx6½H

**B. BAMBOO ACRYLIC BEVERAGE DISPENSER**  
1.5 and 3 Gallon Capacity. Includes Drip Tray.

**ICE CHAMBER**

- ITEM 1527-1-60 | 8¼Wx9¾Dx17¾H
- ITEM 1527-3-60 | 8¼Wx9¾Dx25¾H

**INFUSION CHAMBER**

- ITEM 1527-1INF-60 | 8¼Wx9¾Dx17¾H
- ITEM 1527-3INF-60 | 8¼Wx9¾Dx25¾H

**D. BAMBOO 9 SECTION CONDIMENT ORGANIZER**  
ITEM 1714-60 | 12Wx12Dx5½H

Please visit [www.calmil.com/legal](http://www.calmil.com/legal) for a complete list of California Proposition 65 related items.

# BAMBOO collection



A COMPLETE, ENVIRONMENTALLY FRIENDLY LINE, comprised of highly-sustainable bamboo. Its refreshing design offers a perfect blend of traditional and organic styles to promote an economically responsible product line that continues to increase in popularity.



# BAMBOO collection



A

3332-10-60

Porcelain  
Platter



3332-7-60



3332-4-60

B

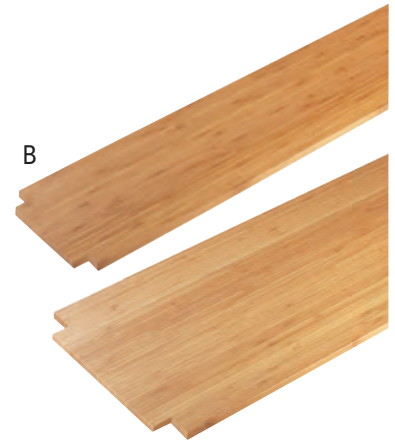

## A. BAMBOO CRATE RISERS

Platters are Sold Separately.

ITEM 3331-60 | 9Wx9Dx18H

ITEM 3332-4-60 | 12Wx12Dx4H

ITEM 3332-7-60 | 12Wx12Dx7H

ITEM 3332-10-60 | 12Wx12Dx10H

## B. NOTCHED BAMBOO SHELVES

All 1435 Shelves are Notched to Fit Crates.

ITEM 1435-1224-60 | 24Wx12Dx½H

ITEM 1435-1232-60 | 32Wx12Dx½H

ITEM 1435-1248-60 | 48Wx12Dx½H

ITEM C732-60 | 32Wx7Dx¼H



3331-60



C

## C. COLD CONCEPT SET ❄️

Complete Set Includes: Porcelain Plate, Liner, and Cold Pack. Lid Sold Separately. Place Cold Pack in Freezer for a Minimum of 6 Hours. Keeps Contents Cold for 2-3 Hours.

ITEM 3063 | Porcelain Plate, Liner, Cold Pack

ITEM 3402 | Hinged Dome Lid



D

## D. PORCELAIN AND MELAMINE PLATTERS

ITEM SR152 | 23Wx7Dx1H | Melamine

ITEM PP150 | 18Wx3Dx1H | Porcelain

ITEM PP151 | 20Wx5Dx1H | Porcelain

ITEM PP152 | 23Wx7Dx1H | Porcelain

E



## E. PORCELAIN OR MELAMINE PLATTER

ITEM PP252 | 12Wx12Dx1¼H | Porcelain

ITEM SR252 | 11¾Wx11¾Dx1½H | Melamine

Please visit [www.calmil.com/legal](http://www.calmil.com/legal) for a complete list of California Proposition 65 related items.



**F. ROUND MELAMINE JARS W/ WRITE-ON**

Label is Commercial Grade, Scratch and Dent Resistant!

ITEM 1950-16-15C | 4DIAx4¼H | 16 oz.

ITEM 1950-32-15C | 5DIAx5½H | 32 oz.

ITEM 1950-64-15C | 6¾DIAx6¼H | 64 oz.



Round Write On

**G. SQUARE MELAMINE JARS W/ WRITE-ON**

Label is Commercial Grade, Scratch and Dent Resistant!

ITEM C1432BODYC | 4Wx4Dx4H | Jar Only

ITEM 1432-15C | 4Wx4Dx4H | Jar w/ Full Lid

ITEM 1432-15N-C | 4Wx4Dx4H | Jar w/ Notched Lid

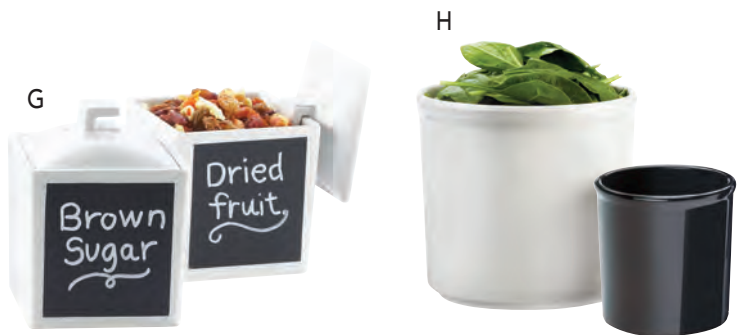

Square Write On

White and Black Round Jars

**H. ROUND MELAMINE JARS**

Specify Color: Black (13), White (15).

ITEM 1950-16 | 4DIAx4¼H | 16 oz.

ITEM 1950-32 | 5DIAx5½H | 32 oz.

ITEM 1950-64 | 6¾DIAx6¼H | 64 oz.

**I. SQUARE MELAMINE JARS**

ITEM C1432BODY | 4Wx4Dx4H | Jar Only

ITEM 1432-15 | 4Wx4Dx4H | Jar w/Full Lid

ITEM 1432-15N | 4Wx4Dx4H | Jar w/Notched Lid



Square Jars White Only

**J. ROUND PORCELAIN PLATTER**

ITEM PP1167 | 12¾DIAx1¼H



Please visit [www.calmil.com/legal](http://www.calmil.com/legal) for a complete list of California Proposition 65 related items.



# BAMBOO collection



**A. BAMBOO LIBRARY DISPLAY**  
Removable Small Shelf. Cubes Sold Separately.  
1933-60 Ships by Truck Only.  
ITEM 1933-60 | 38Wx12Dx24H | Library  
ITEM 1929-12-60 | 12Wx12Dx12H | Cube

**B. BAMBOO LIBRARY CUBES**  
ITEM 1929-12-60 | 12Wx12Dx12H

**C. BAMBOO RECTANGULAR CRATE RISERS**  
ITEM 1943-3-60 | 20Wx7Dx3H  
ITEM 1943-7-60 | 20Wx7Dx7H  
ITEM 1943-11-60 | 20Wx7Dx11H

**D. BAMBOO SQUARE CRATE RISERS**  
These Risers Can Also be Used as Bins and Work  
with Our Bamboo Shelves (See Page 84).  
ITEM 1944-6-60 | 6Wx6Dx6H  
ITEM 1944-9-60 | 9Wx9Dx9H  
ITEM 1944-12-60 | 12Wx12Dx12H  
ITEM 3332-4-60 | 12Wx12Dx4H  
ITEM 3332-7-60 | 12Wx12Dx7H  
ITEM 3332-10-60 | 12Wx12Dx10H

Please visit [www.calmil.com/legal](http://www.calmil.com/legal) for a complete list of California Proposition 65 related items.



**E. BAMBOO CUBE RISERS**

ITEM 432-3-60 | 12Wx12Dx3H

ITEM 432-6-60 | 12Wx12Dx6H

ITEM 432-9-60 | 12Wx12Dx9H

**F. BAMBOO RECTANGLE RISERS**

ITEM 166-3-60 | 20Wx7Dx3H

ITEM 166-7-60 | 20Wx7Dx7H

ITEM 166-11-60 | 20Wx7Dx11H



**G. BAMBOO CRATE ACRYLIC BEVERAGE DISPENSER**

3 Gallon Capacity. Works with Our Bamboo Shelves (See Page 84).

3301-3-60 | 8WX8DX25½H | Ice

3301-3INF-60 | 8WX8DX25½H | Infusion

**H. IRON/BAMBOO RISERS**

ITEM 1711-3-60 | 12Wx12Dx3H

ITEM 1711-5-60 | 12Wx12Dx5H

ITEM 1711-7-60 | 12Wx12Dx7H



**I. BAMBOO SQUARE CHANGE UP RISER**

Riser and Tray Inserts Sold Separately.

**RISER**

ITEM 1476-12 | 12½Wx12½Dx6H | Square

**OPTIONAL BAMBOO TRAYS**

ITEM 1481-12-60 | Large Square Flat Tray | 12Wx12Dx¾H

ITEM 1477-12-60 | Large Square Deep Tray | 12Wx12Dx3¼H



Please visit [www.calmil.com/legal](http://www.calmil.com/legal) for a complete list of California Proposition 65 related items.



# BAMBOO collection



A

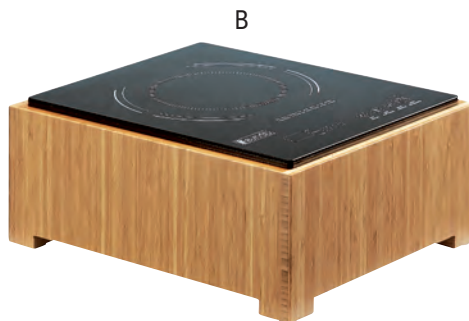

B



C

Fill the Decorative Infusion Wall with Sliced Fruit for an Innovative Display!



D



E

3439-60 with  
3067 Optional  
Griddle

3440-60



F



G



## A. BAMBOO BUTANE STOVE FRAME

Optional Butane Stove Sold Separately.

ITEM 3435-60 | 14½Wx13Dx7½H

ITEM 4010-I | Optional Butane Stove

## B. BAMBOO INDUCTION BURNER

Induction Burner Included.

3633-60 | 12¾Wx16Dx7¼H

## C. BAMBOO DISPENSER W/ DECORATIVE INFUSION WALL

3 Gallon Capacity. Includes Drip Tray.

3697-3-60 | 8¼Wx9¾Dx25¾H

## D. BAMBOO CHAFER

Includes Stainless Steel Chafer Cover.

ITEM 3821-60 | 22Wx14Dx13H

## E. BAMBOO CHAFER ALTERNATIVES

Griddle for 3439-99 Sold Separately.

ITEM 3440-60 | 10¼Wx10Dx5½H

ITEM 3439-60 | 19¾Wx10Dx5½H

## OPTIONAL GRIDDLES FOR 3439-60

ITEM 1362 | Griddle w/ Brackets

ITEM 3067 | Griddle w/ Heat Guard Handles

## F. BAMBOO ROOM SERVICE TRAY

ITEM 958-1-60 | 22½Wx17Dx1½H

## G. BAMBOO DRIP TRAYS

Drip Trays are Removable for Cleaning.

ITEM 330-4-60 | 4Wx4Dx1H

ITEM 330-6-60 | 6Wx6Dx1H

Please visit [www.calmil.com/legal](http://www.calmil.com/legal) for a complete list of California Proposition 65 related items.



**H. BAMBOO BAKERY DISPLAY CASES**  
Includes 3 — 13" x 18" Clear Trays.  
Self and Attendant Serve with 3 Tray Positions.  
ITEM 284-60 | 21Wx16¼Dx22½H  
ITEM 325-13-12 | Replacement Tray

**I. BAMBOO 4 DRAWER BREAD CASE**  
Bamboo Frame, Acrylic Drawers.  
1718-60 | 16½Wx15Dx15H  
C1718DRAWER | Replacement Drawer

**J. BAMBOO CRUMB CATCHER**  
Top Removable for Cleaning.  
ITEM 823 | 13¾Wx8Dx1½H

**K. BAMBOO TRAY AND RISER**  
Fits Standard Muffin Pan.  
Pieces Sold Separately.  
ITEM 1339-60 | 16Wx11Dx2H | Bamboo Tray  
ITEM 1339-RISER | 9Wx8¼Dx2H | Clear Riser

**L. BAMBOO 2 DRAWER BREAD CASE**  
Stackable; Bamboo Frame, Acrylic Drawers.  
ITEM 1337-60 | 14Wx13½Dx5¾H

Please visit [www.calmil.com/legal](http://www.calmil.com/legal) for a complete list of California Proposition 65 related items.



# BAMBOO collection



A



3308-60

B



C

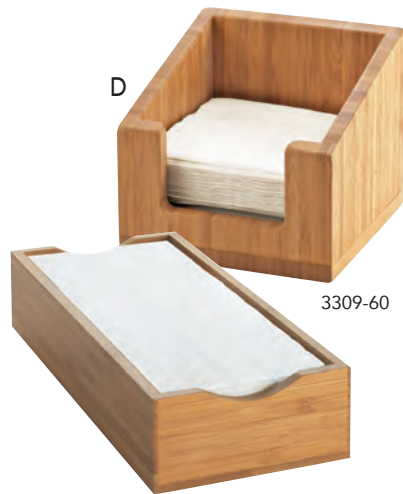

3309-60

D



E



F



G



H

## A. BAMBOO 3 STEP JAR DISPLAY

Includes Three Glass Jars.

ITEM 1486 | 5Wx14Dx13H

ITEM C4X4GLCN | Replacement Jar

## B. BAMBOO STRAW ORGANIZERS

ITEM 3308-60 | 5Wx5Dx5½H

## C. BAMBOO FLATWARE DISPLAY

ITEM 1244 | 8¼Wx5½Dx4¾H

## D. BAMBOO NAPKIN DISPLAYS

ITEM 1234 | 4Wx8D | Napkin Size

ITEM 3309-60 | 5Wx5D | Napkin Size

## E. BAMBOO COUNTERTOP TRASH BIN

ITEM 1717-60 | 5Wx5Dx7H

## F. BAMBOO NAPKIN OR LID ORGANIZER

Holds up to 3.75" Diameter Cups & Lids.

ITEM 298-60 | 4½Wx4½Dx8H

## G. BAMBOO BEVERAGE SIGNS

Dimensions: 3Wx1Dx2H.

ITEM 606-1 | COFFEE

ITEM 606-2 | DECAF

ITEM 606-3 | HOT WATER

ITEM 606-4 | TEA

## H. BAMBOO COFFEE SLEEVE DISPENSER

ITEM 2050-60 | 5¾Wx12Dx3¾H

Please visit [www.calmil.com/legal](http://www.calmil.com/legal) for a complete list of California Proposition 65 related items.

**I. BAMBOO PACKET ORGANIZERS**

ITEM 796-60 | 9Wx6¼Dx4½H  
 ITEM 1246 | 9½Wx4½Dx2¼H



**J. BAMBOO CONDIMENT STATION**

Pieces Sold Separately.  
 ITEM 2019-60 | 15Wx14½Dx9¼H  
 ITEM 298-60 | 4½Wx4½Dx8H | 3 Shown



**K. BAMBOO COMPARTMENT SPACESAVER**

Use for Condiments or Flatware.  
 Cylinders Sold Separately.  
 ITEM 1426-60 | 12Wx14¼Dx16½H



**L. BAMBOO CYLINDER STAND**

3 or 6 Cylinders Available.  
 Cylinders Sold Separately.  
 ITEM 1425-3-60 | 16Wx5½Dx6H | 3 Cylinder  
 ITEM 1425-6-60 | 16Wx11Dx6H | 6 Cylinder



**M. BAMBOO 3 TIER CYLINDER DISPLAY**

Use for Condiments or Flatware!  
 Cylinders Sold Separately.  
 ITEM 1016-3-60 | 6¼Wx9½Dx22¾H

K



**OPTIONAL CYLINDERS**

Available in Six Colors.  
 Stainless Steel Style: Perforated (39), (SOLID).  
 Colored Melamine: Black (13), White (15),  
 Butter Yellow (61), Terra Cotta (62), Sage (63),  
 Cranberry (64). Extra Deep: White (8-15).

ITEM 1017-39 | 4½DIAx5½H  
 ITEM 1017-SOLID | 4½DIAx5½H  
 ITEM 1017 | 4½DIAx5½H  
 ITEM 1017-8-15 | 4½DIAx8H | Extra Deep

M



Please visit [www.calmil.com/legal](http://www.calmil.com/legal) for a complete list of California Proposition 65 related items.



# BAMBOO collection

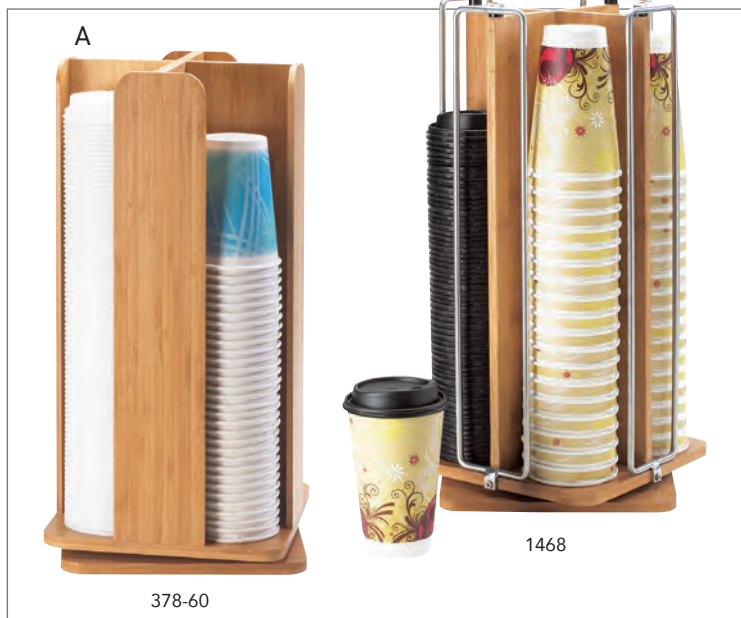

**A. BAMBOO REVOLVING CUP & LID ORGANIZERS**  
 Holds up to 3.75" Diameter Cups & Lids.  
 ITEM 378-60 | 8Wx8Dx18¼H  
 ITEM 1468 | 9Wx9Dx18½H

**B. BAMBOO DUAL AIRPOT DISPLAY**  
 Includes 2 Drip Trays. Airtops Not Included.  
 ITEM 360-2-60 | 7½Wx23½Dx15¼H

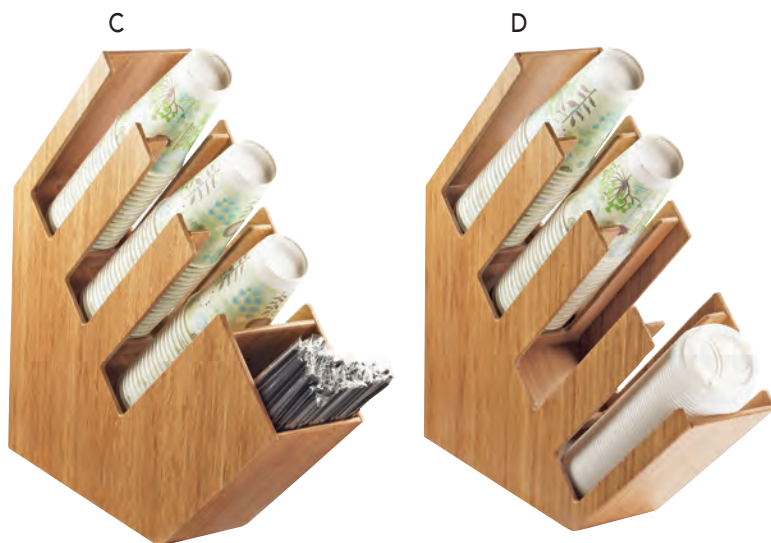

**C. BAMBOO CUP, LID, & STRAW HOLDER**  
 ITEM 2051-60 | 4¾Wx20Dx19½H

**D. 3 OR 4 SECTION BAMBOO CUP & LID HOLDER**  
 ITEM 2048-3-60 | 4½Wx17Dx16¼H  
 ITEM 2048-4-60 | 4½Wx20Dx19½H

**E. BAMBOO/MIDNIGHT BAMBOO REVERSIBLE RISERS**  
 Pry Frame Away From Bamboo to Remove, Then Place Bamboo Back Inside Frame. Sides are Bamboo (-60) and Midnight Bamboo (-96).

**SQUARE**  
 ITEM 3725-3 | 12Wx12Dx3½H  
 ITEM 3725-5 | 12Wx12Dx6H  
**ROUND**  
 ITEM 3726-3 | 12DIAx3½H  
 ITEM 3726-5 | 12DIAx6H



Please visit [www.calmil.com/legal](http://www.calmil.com/legal) for a complete list of California Proposition 65 related items.

**F. BAMBOO 9 BIN DISPLAY**

Includes 9 Bamboo Bins.  
Specify Frame Color: Black (13), Platinum (39).  
ITEM 1817 | 13Wx9½Dx17½H  
ITEM C4X4-60 | Replacement Bin



**G. BAMBOO FLATWARE/CONDIMENT DISPLAY**

Dimensions: 5¼Wx14Dx18H.  
Includes 3 Bamboo Bins.  
ITEM 1235-13-60 | Black Frame  
ITEM 1235-39-60 | Platinum Frame  
ITEM 1234 | 9½Wx4½Dx2H | Replacement Bin



**H. BAMBOO CONDIMENT ORGANIZERS**

ITEM 2053-60 | 7Wx5Dx16H | 3 Section  
ITEM 2054-60 | 10¼Wx6¾Dx16H | 6 Section

**I. REMOVABLE COMPARTMENT CONDIMENT ORGANIZER**

ITEM 3569-6-60 | 13¼Wx7Dx23¼H

**J. BAMBOO STIR STICK & CONDIMENT ORGANIZER**

Divider is Removable to Create More Capacity.  
ITEM 2052-60 | 5½Wx13¼Dx14½H



2054-60



Removable Divider



Please visit [www.calmil.com/legal](http://www.calmil.com/legal) for a complete list of California Proposition 65 related items.



# BAMBOO collection



A



B



C

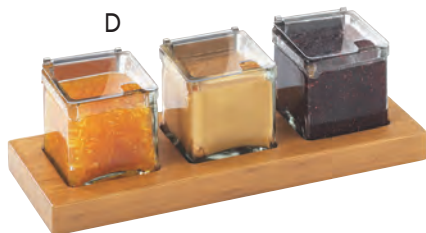

D



E



F

## A. BAMBOO ELEVATION STAND

ITEM 1930-60 | 18Wx18Dx20¼H

## B. BAMBOO CUPCAKE DISPLAY

ITEM 1318-60 | 20Wx20Dx17¼H

## C. BAMBOO COLD JAR DISPLAY ❄️

Includes Base, Jars, Lids, and Cooling Pucks. Specify Lid Type.

ITEM 1850-4-60 | 16Wx6Dx4H-w/ Solid Lid

ITEM 1850-4-60HL | 16Wx6Dx4H- w/ Hinged Lid

## D. BAMBOO GLASS JAR HOLDER

Includes 3 Glass Jars & Notched Lids.

ITEM 1338-60 | 13Wx5Dx5½H

### OPTIONAL ACRYLIC LIDS & REPLACEMENT JARS

ITEM 1811 | Solid | Soft Hinge

ITEM 1807 | Solid | Metal Hinge

ITEM 1807-N | Notched | Metal Hinge

ITEM C4X4GLCN | Replacement Jar

## E. BAMBOO CLIPBOARD MENU

ITEM 2036-32-60 | CARD SIZE 3Wx2H

ITEM 2036-46-60 | CARD SIZE 4Wx6H

ITEM 2036-811-60 | CARD SIZE 8½Wx11H

## F. BAMBOO WRITE-ON/CARDHOLDER

Use Dry or Wet Erase Markers.

ITEM 1103-23-12 | 3½Wx2H | Cardholder

ITEM 1103-23-60 | 3½Wx2H | Write-On

ITEM 1103-811-12 | 8½Wx11H | Cardholder

ITEM 1103-811-60 | 8½Wx11H | Write-On

Please visit [www.calmil.com/legal](http://www.calmil.com/legal) for a complete list of California Proposition 65 related items.



**G. MISSION 2 TIER STAND**  
Stand Only, Trays Sold Separately.  
ITEM 1722 | 23Wx13Dx15H | Stand  
ITEM 1367-12-60 | 19¾Wx11¼Dx1¼H | Tray



**H. 2 TIER IRON STAND**  
12Wx20D Bins and Trays Sold Separately.  
ITEM 1330-12-13 | 26¼Wx12½Dx27½H



**I. BAMBOO ROLL TOP COVER**  
ITEM 1333-60 | 20Wx11½Dx6½H



**J. BAMBOO BINS WITH LID**  
ITEM 1332-12-60 | 20Wx12Dx7H  
ITEM 1332-12-INSERT | Liner for 12x20 Bin



**K. BAMBOO TRAYS**  
ITEM 1367-10-60 | 12Wx9¼Dx1¼H  
ITEM 1367-12-60 | 19¾Wx11¼Dx1¼H



**L. BAMBOO BASE CARDHOLDER**  
Bamboo Base, Acrylic Signholder.  
ITEM 1510-32-60 | 3½Wx2H  
ITEM 1510-411-60 | 4¼Wx11H  
ITEM 1510-46-60 | 4Wx6H  
ITEM 1510-811-60 | 8½Wx11H



**M. BAMBOO WET FLOOR SIGN**  
Two-Sided.  
ITEM 852-60 | 12Wx17½Dx22H

Please visit [www.calmil.com/legal](http://www.calmil.com/legal) for a complete list of California Proposition 65 related items.



# BAMBOO collection

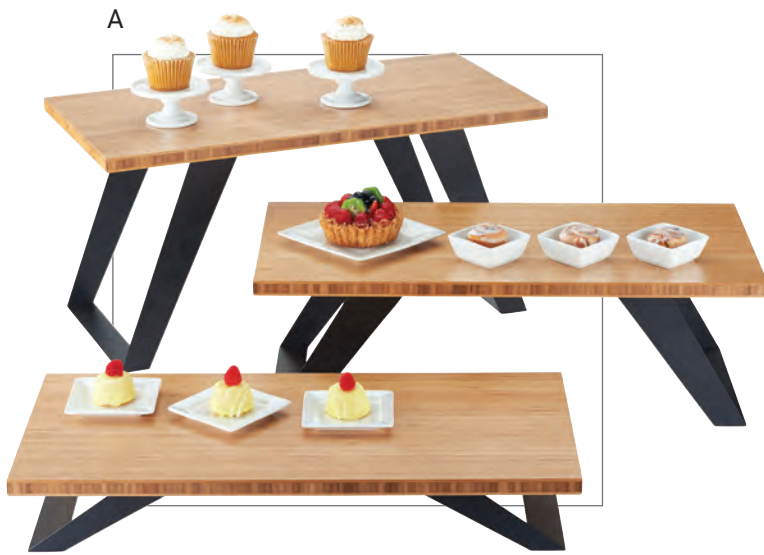

## A. BAMBOO STAIR-STEP RISERS

ITEM 3374-4-60 | 24Wx11¼Dx4H  
 ITEM 3374-8-60 | 24Wx11¼Dx8H  
 ITEM 3374-12-60 | 24Wx11¼Dx12H

## C. BAMBOO FOLDING RISERS

Risers Fold Down Flat.  
 ITEM 3620-5-60 | 10Wx10Dx5H  
 ITEM 3620-8-60 | 10Wx10Dx7¾H  
 ITEM 3620-11-60 | 10Wx10Dx10¾H

## B. BAMBOO APPETIZER TRAY **NEW**

Includes Stainless Steel Divided Liner.  
 ITEM 22052-60 | 9Wx9Dx1½H

## D. BAMBOO DONUT/BAGEL DISPLAY

ITEM 22008-4-60 | 25Wx7Dx13H  
 OPTIONAL BASE  
 ITEM 22013-60 | 7Wx13Dx2½H

Please visit [www.calmil.com/legal](http://www.calmil.com/legal) for a complete list of California Proposition 65 related items.



3836-3-60



3837-3-60



3633-60

**E. INDUCTION BURNER ACTION STATION**

All Pieces Sold Separately. Jar and 1/6 Pan Holders Include Jars, Pans, and Ice Packs.

ITEM 3633-60 | 12¾Wx16Dx7¼H

ITEM 3836-3-60 | 15¾Wx5½Dx8¾H

ITEM 3837-3-60 | 11¾Wx7¾Dx6¼H



**F. BAMBOO MULTI-LEVEL SHELF DISPLAY**

Bamboo Shelves are Removable for Cleaning. Ships Truck Only.

ITEM 3303-60 | 28½Wx13½Dx36½H | Black Frame

ITEM 3304-60 | 28½Wx13½Dx36½H | Silver Frame

Please visit [www.calmil.com/legal](http://www.calmil.com/legal) for a complete list of California Proposition 65 related items.



# ECO MODERN collection



A



B



C

## A. ECO MODERN CEREAL DISPENSERS

ITEM 1499 | 18¼Wx13¼Dx24½H - Bamboo

ITEM 1499-15 | 18¼Wx13¼Dx24½H - White

## B. ECO MODERN BREAD CASES

ITEM 1279 | 14Wx11½Dx15H - Bamboo

ITEM 1279-15 | 14Wx11½Dx15H - White

ITEM 1480 | Replacement Bin w/ 2 Drawers

ITEM C1480DRAWER | Replacement Drawer

## C. ECO MODERN CYLINDER HOLDERS

Cylinders Sold Separately.

ITEM 1283 | 6½Wx8Dx17H - Bamboo

ITEM 1283-15 | 6½Wx8Dx17H - White

### OPTIONAL CYLINDERS

Available in Six Colors.

Stainless Steel Style: Perforated (39), (SOLID).  
Colored Melamine: Black (13), White (15),  
Butter Yellow (61), Terra Cotta (62), Sage (63),  
Cranberry (64). Extra Deep: White (8-15).

ITEM 1017-39 | 4½DIAx5½H

ITEM 1017-SOLID | 4½DIAx5½H

ITEM 1017 | 4½DIAx5½H

ITEM 1017-8-15 | 4½DIAx8H - Extra Deep

Please visit [www.calmil.com/legal](http://www.calmil.com/legal) for a complete list of California Proposition 65 related items.





# ECO MODERN

collection

**AS AN ENVIRONMENTALLY RESPONSIBLE LINE**, this collection pairs eco-friendly bamboo with modern metal frames. Available in traditional or white-painted finish, this fully established line provides the perfect balance of beauty without compromising durability.



# ECO MODERN collection

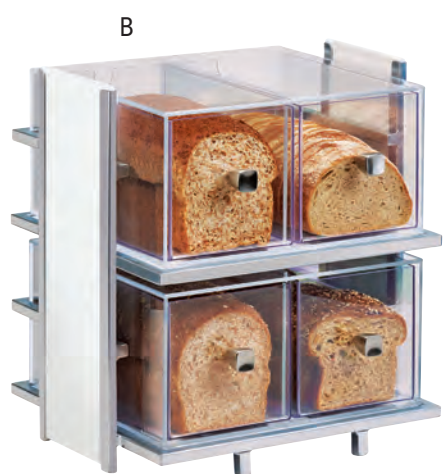
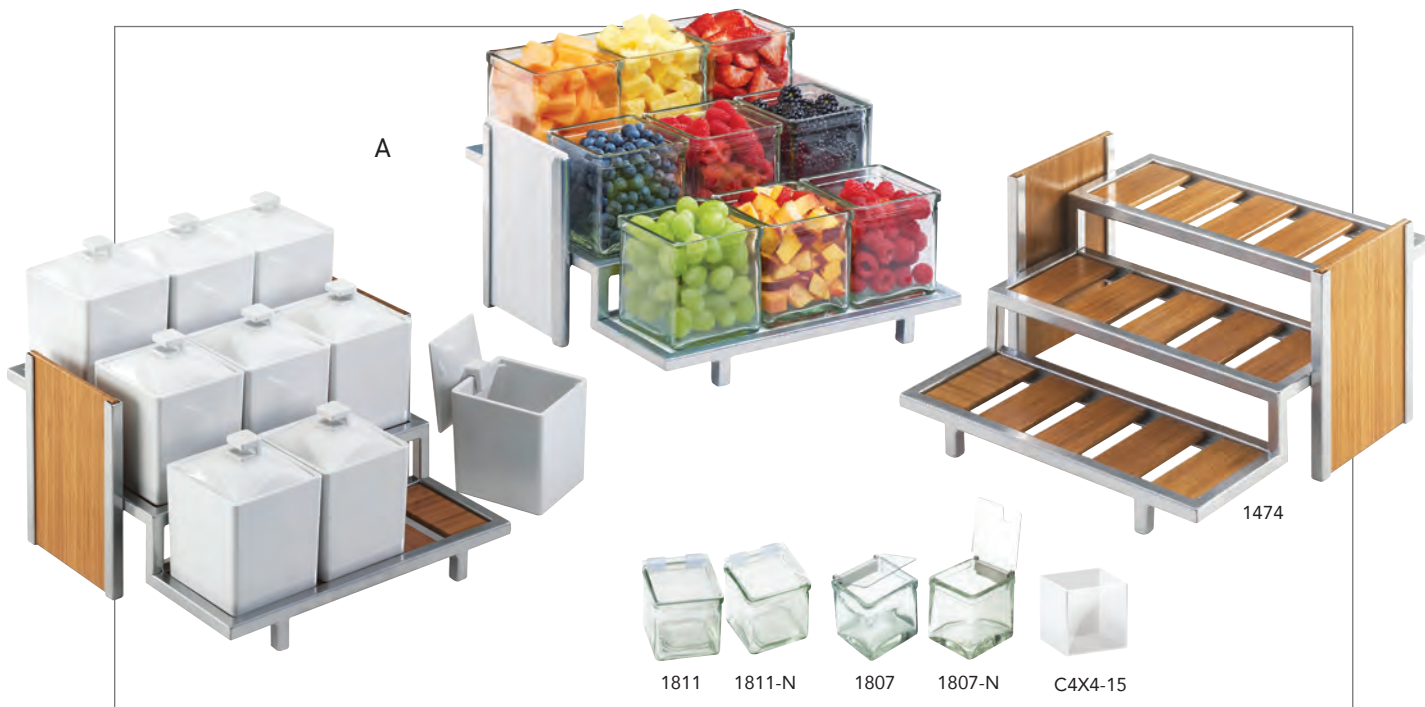

## A. ECO MODERN 9 JAR DISPLAYS

Frame and Jars Sold Separately.

### FRAMES

ITEM 1474 | 13¾Wx13¾Dx7H - Bamboo Frame

ITEM 1474-15 | 13¾Wx13¾Dx7H - White Bamboo Frame

### OPTIONAL JARS

ITEM C4X4GLCN | 4Wx4D - Glass Jar

ITEM 1432-15 | 4Wx4D - Melamine Jar w/ Lid

ITEM 1432-15N | 4Wx4D Melamine Jar w/ Notched Lid

ITEM C4X4-15 | 4Wx4D - 2 Tone White and Clear Plastic Jar

### OPTIONAL GLASS JAR LIDS

ITEM 1807 | 4Wx4Dx½H - S/S Hinge

ITEM 1807-N | 4Wx4Dx½H - S/S Hinge Notched

ITEM 1811 | 4Wx4Dx½H - Plastic Hinge

ITEM 1811-N | 4Wx4Dx½H - Plastic Hinge Notched

Please visit [www.calmil.com/legal](http://www.calmil.com/legal) for a complete list of California Proposition 65 related items.

## B. ECO MODERN BREAD CASES

ITEM 1279 | 14Wx11½Dx15H - Bamboo

ITEM 1279-15 | 14Wx11½Dx15H - White

ITEM 1480 | Replacement Bin w/ Drawers

ITEM C1480DRAWER | Replacement Drawer

## C. ECO MODERN 2 TIER MERCHANDISERS

ITEM 1278 | 14Wx11½Dx15H - Bamboo

ITEM 1278-15 | 14Wx11½Dx15H - White



D

1471-15



D

1471

**D. ECO MODERN MERCHANDISERS**

Pieces Sold Individually or as a Set.  
Set Includes Frame, Bread Bin w/ Drawers,  
and Bin w/ Cover.

**COMPLETE SETS**

ITEM 1471-SET | 21Wx13Dx13H - Set/Bamboo

ITEM 1471-15SET | 21Wx13Dx13H - Set/White

**COMPONENTS**

ITEM 1471 | Frame Only - Bamboo

ITEM 1471-15 | Frame Only - White

ITEM 1478 | Bin with Cover

ITEM 1479 | Bread Bin with Drawers

ITEM 1479DRAWER | Replacement Drawer

D



1478  
Bin w/ Cover

1479  
Bread Bin w/  
3 Drawers

1471  
Frame

1471-SET



D

1471-15SET

Please visit [www.calmil.com/legal](http://www.calmil.com/legal) for a complete list of California Proposition 65 related items.



# MIDNIGHT BAMBOO collection

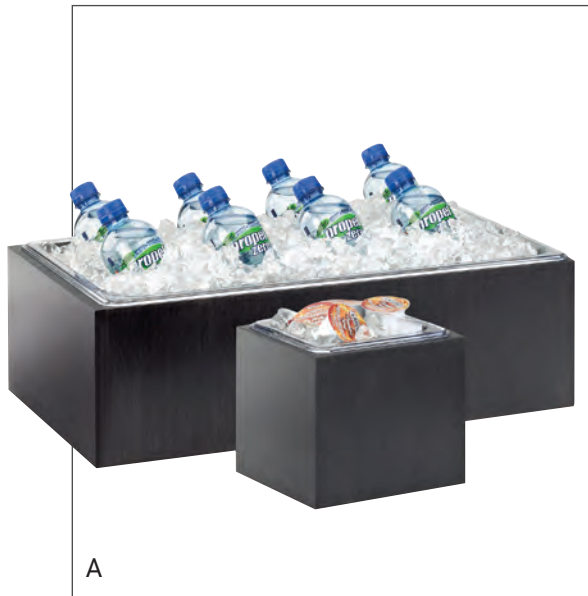

A



B



C



D

## A. MIDNIGHT BAMBOO ICE HOUSINGS

Includes Clear Polycarbonate Pan.

ITEM 475-6-96 | 6Wx7Dx6½H

ITEM 475-10-96 | 10Wx12Dx6½H

ITEM 475-12-96 | 12Wx20Dx6½H

## C. MIDNIGHT BAMBOO CRATE BEVERAGE DISPENSERS

3 Gallon Capacity. Includes Drip Tray.

### ICE CHAMBER

ITEM 3301-3-96 | 8Wx8Dx25½H

### INFUSION CHAMBER

ITEM 3301-3INF-96 | 8Wx8Dx25½H

## B. MIDNIGHT BAMBOO BEVERAGE DISPENSERS

1.5 and 3 Gallon Capacity. Includes Drip Tray.

### ICE CHAMBER

ITEM 1527-1-96 | 8¼Wx9¾Dx17¾H

ITEM 1527-3-96 | 8¼Wx9¾Dx25¾H

### INFUSION CHAMBER

ITEM 1527-1INF-96 | 8¼Wx9¾Dx17¾H

ITEM 1527-3INF-96 | 8¼Wx9¾Dx25¾H

## D. MIDNIGHT BAMBOO 9 BIN TIER DISPLAY

Includes 9 Bins.

ITEM 1817-96 | 13Wx9½Dx17½H

ITEM C4X4-96 | Replacement Bin

Please visit [www.calmil.com/legal](http://www.calmil.com/legal) for a complete list of California Proposition 65 related items.

# MIDNIGHT BAMBOO

collection



A BOLD TWIST ON TRADITIONAL BAMBOO, this collection is comprised of the same environmentally friendly material painted midnight black. Its sleek design is both modern and classic, making it the perfect line to display while still presenting economically responsible items.

Please visit [www.calmil.com/legal](http://www.calmil.com/legal) for a complete list of California Proposition 65 related items.

CAL•MIL | visit us online at: [www.calmil.com](http://www.calmil.com) | call toll-free 800-321-9069



# MIDNIGHT BAMBOO collection

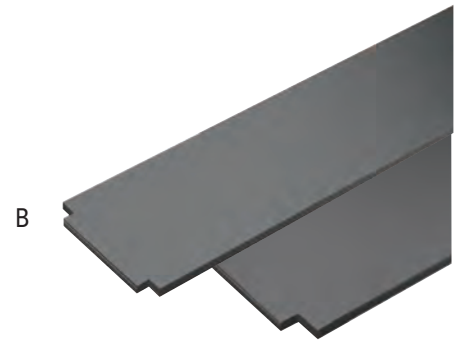
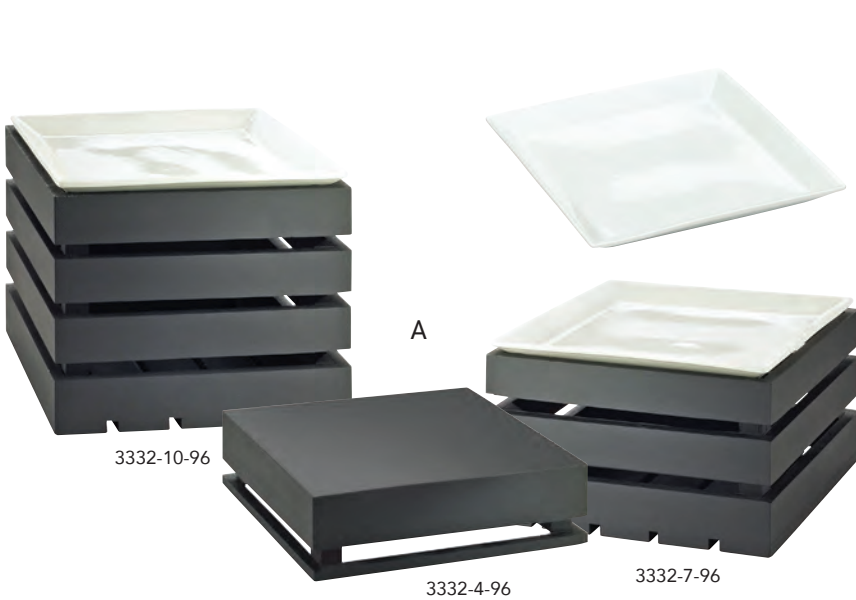

## A. MIDNIGHT BAMBOO CRATE RISERS

Platters are Sold Separately.

ITEM 3331-96 | 9Wx9Dx18H

ITEM 3332-4-96 | 12Wx12Dx4H

ITEM 3332-7-96 | 12Wx12Dx7H

ITEM 3332-10-96 | 12Wx12Dx10H

### OPTIONAL PLATTERS

ITEM PP252 | 12Wx12Dx1¼H - Porcelain

ITEM SR252 | 11¼Wx11¼Dx1½H - Melamine

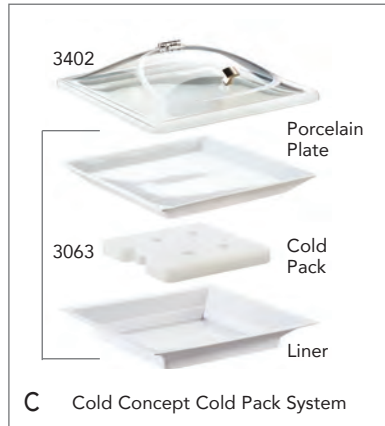

## B. MIDNIGHT BAMBOO SHELVES

All 1435 Shelves are Notched to Fit Crates.

ITEM 1435-1224-96 | 24Wx12Dx½H

ITEM 1435-1232-96 | 32Wx12Dx½H

ITEM 1435-1248-96 | 48Wx12Dx½H

ITEM C732-96 | 32Wx7Dx¼H

## C. COLD CONCEPT SET ❄️

Complete Set Includes: Porcelain Plate, Liner, and Cold Pack. Lid Sold Separately. Place Cold Pack in Freezer for a Minimum of 6 Hours. Keeps Contents Cold for 2-3 Hours.

ITEM 3063 | Porcelain Plate, Liner, Cold Pack

ITEM 3402 | Hinged Dome Lid

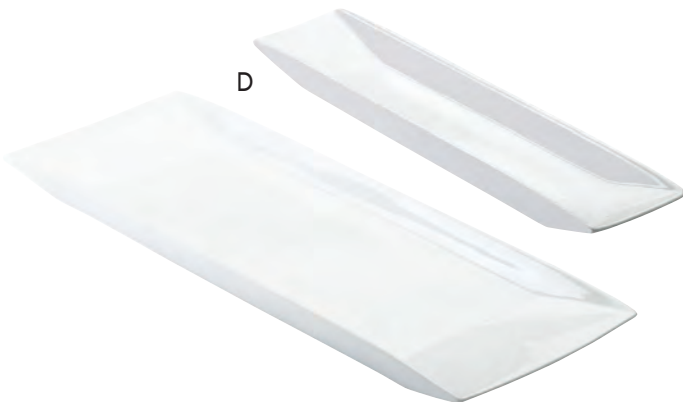

## D. PORCELAIN AND MELAMINE PLATTERS

ITEM SR152 | 23Wx7Dx1H - Melamine

ITEM PP150 | 18Wx3Dx1H - Porcelain

ITEM PP151 | 20Wx5Dx1H - Porcelain

ITEM PP152 | 23Wx7Dx1H - Porcelain

## E. PORCELAIN OR MELAMINE PLATTER

ITEM PP252 | 12Wx12Dx1¼H - Porcelain

ITEM SR252 | 11¼Wx11¼Dx1½H - Melamine

Please visit [www.calmil.com/legal](http://www.calmil.com/legal) for a complete list of California Proposition 65 related items.



**F. ROUND MELAMINE JARS W/ WRITE-ON**

Label is Commercial Grade, Scratch and Dent Resistant.

ITEM 1950-16-15C | 4DIAx4¼H | 16 oz.

ITEM 1950-32-15C | 5DIAx5½H | 32 oz.

ITEM 1950-64-15C | 6¾DIAx6¼H | 64 oz.

Round Write On



F

**G. SQUARE MELAMINE JARS W/ WRITE-ON**

Label is Commercial Grade, Scratch and Dent Resistant.

ITEM C1432BODYC | 4Wx4Dx4H | Jar Only

ITEM 1432-15C | 4Wx4Dx4H | Jar w/Full Lid

ITEM 1432-15N-C | 4Wx4Dx4H | Jar w/Notched Lid

Square Write On



G

White and Black Round Jars



H

**H. ROUND MELAMINE JARS**

Specify Color: Black (13), White (15).

ITEM 1950-16 | 4DIAx4¼H | 16 oz.

ITEM 1950-32 | 5DIAx5½H | 32 oz.

ITEM 1950-64 | 6¾DIAx6¼H | 64 oz.

**I. SQUARE MELAMINE JARS**

ITEM C1432BODY | 4Wx4Dx4H | Jar Only

ITEM 1432-15 | 4Wx4Dx4H | Jar w/Full Lid

ITEM 1432-15N | 4Wx4Dx4H | Jar w/Notched Lid

Square Jars White Only



I

**J. ROUND PORCELAIN PLATTER**

ITEM PP1167 | 12¾DIAx1¼H



J

Please visit [www.calmil.com/legal](http://www.calmil.com/legal) for a complete list of California Proposition 65 related items.



# MIDNIGHT BAMBOO collection

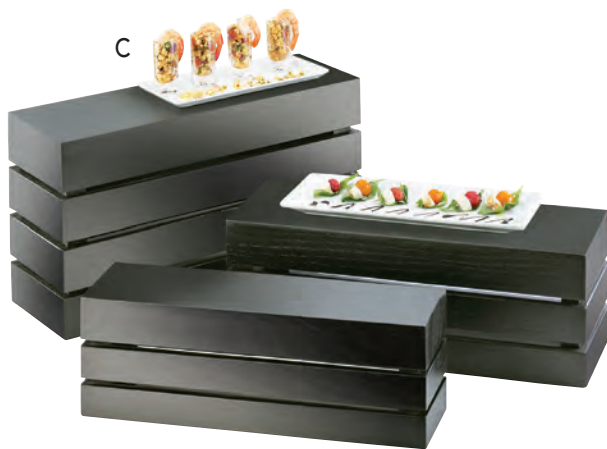

## A. MIDNIGHT BAMBOO CUBE

Sold Individually.

ITEM 1929-12-96 | 12Wx12Dx12H

## B. MIDNIGHT BAMBOO LIBRARY DISPLAY

Removable Small Shelf. Cubes Sold Separately.

ITEM 1933-96 | 38Wx12Dx24H - Library

ITEM 1929-12-96 | 12Wx12Dx12H - Cube

## C. MIDNIGHT BAMBOO RECTANGULAR CRATE RISERS

These Risers Can Also be Used as Bins and Work with Our Midnight Bamboo Shelves (See Page 104).

ITEM 1943-3-96 | 20Wx7Dx3H

ITEM 1943-7-96 | 20Wx7Dx7H

ITEM 1943-11-96 | 20Wx7Dx11H

## D. MIDNIGHT BAMBOO SQUARE CRATE RISERS

These Risers Can Also be Used as Bins and Work with Our Midnight Bamboo Shelves. (See Page 104).

ITEM 1944-6-96 | 6Wx6Dx6H

ITEM 1944-9-96 | 9Wx9Dx9H

ITEM 1944-12-96 | 12Wx12Dx12H

ITEM 3332-4-96 | 12Wx12Dx4H

ITEM 3332-7-96 | 12Wx12Dx7H

ITEM 3332-10-96 | 12Wx12Dx10H

Please visit [www.calmil.com/legal](http://www.calmil.com/legal) for a complete list of California Proposition 65 related items.



**E. MIDNIGHT BAMBOO CUBE RISERS**

ITEM 432-3-96 | 12Wx12Dx3H  
 ITEM 432-6-96 | 12Wx12Dx6H  
 ITEM 432-9-96 | 12Wx12Dx9H



**F. MIDNIGHT BAMBOO RECTANGULAR RISERS**

ITEM 166-3-96 | 20Wx7Dx3H  
 ITEM 166-7-96 | 20Wx7Dx7H  
 ITEM 166-11-96 | 20Wx7Dx11H



**G. MIDNIGHT BAMBOO SERVING TRAYS NEW**

Includes Removable Acrylic.  
 Easily Customize Any Event!  
 ITEM 22049-1212-96 | 12Wx12Dx1H  
 ITEM 22049-208-96 | 20Wx8Dx1H

Graphic Not Included



Graphic Not Included

**H. MIDNIGHT BAMBOO CUBE RISER SET**

Sizes: 9" Square, 7" Square, and 5" Square.  
 Not Sold Individually.  
 1915-96 | Set of 3

**I. MIDNIGHT BAMBOO STAIR STEP RISERS**

ITEM 1934-4-96 | 20Wx10Dx4H  
 ITEM 1934-8-96 | 22Wx10Dx8H  
 ITEM 1934-12-96 | 24Wx10Dx12H



Please visit [www.calmil.com/legal](http://www.calmil.com/legal) for a complete list of California Proposition 65 related items.



# MIDNIGHT BAMBOO collection



A

**A. MIDNIGHT BAMBOO REVOLVING CUP & LID ORGANIZER**  
 Holds up to 3.75" Diameter Cups & Lids.  
 ITEM 378-96 | 8Wx8Dx18¼H

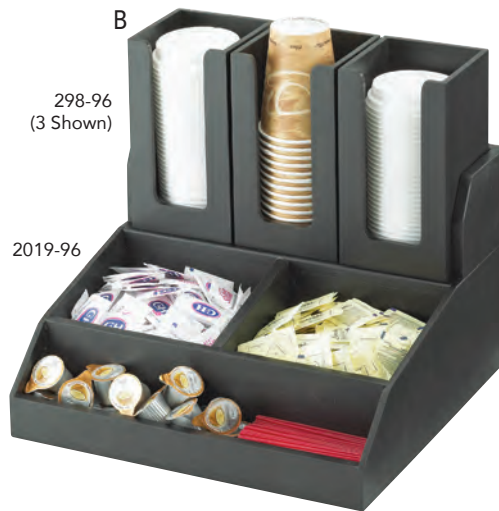

B

298-96  
(3 Shown)

2019-96

**B. MIDNIGHT BAMBOO CONDIMENT STATION**  
 Pieces Sold Separately.  
 ITEM 2019-96 | 15Wx14½Dx9¼H  
 ITEM 298-96 | 4½Wx4½Dx8H - 3 Shown



C

**C. MIDNIGHT BAMBOO 3 STEP JAR DISPLAY**  
 Includes Three Glass Jars.  
 ITEM 1486-96 | 5Wx14Dx13H  
 ITEM C4X4GLCN | Replacement Jar



D

**D. MIDNIGHT BAMBOO U-FRAME CARDHOLDERS**  
 ITEM 1510-32-96 | 3½Wx2H  
 ITEM 1510-46-96 | 4Wx6H  
 ITEM 1510-811-96 | 8½Wx11H

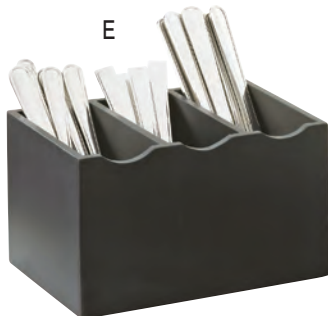

E

**E. MIDNIGHT BAMBOO FLATWARE DISPLAY**  
 ITEM 1244-96 | 8¼Wx5½Dx4¾H

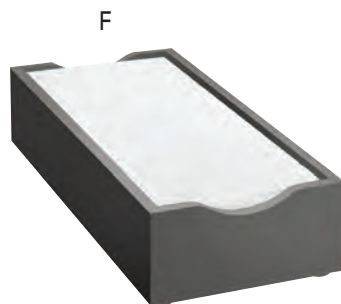

F

**F. MIDNIGHT BAMBOO NAPKIN HOLDER**  
 ITEM 1234-96 | 4Wx8H



G

**G. MIDNIGHT BAMBOO CUP, LID, OR NAPKIN ORGANIZER**  
 Holds up to 3.75" Diameter Cups & Lids.  
 ITEM 298-96 | 4½Wx4½Dx8H



H

**H. MIDNIGHT BAMBOO COUNTERTOP TRASH BIN**  
 ITEM 1717-96 | 5DIAx7H

Please visit [www.calmil.com/legal](http://www.calmil.com/legal) for a complete list of California Proposition 65 related items.

**I. MIDNIGHT BAMBOO  
PACKET ORGANIZERS**

ITEM 796-96 | 9Wx6¼Dx4½H

ITEM 1246-96 | 9½Wx4½Dx2¼H



796-96

**J. MIDNIGHT BAMBOO  
FLATWARE/CONDIMENT DISPLAY**

ITEM 1235-13-96 | 5½Wx14Dx18H

ITEM 1234-96 | Replacement Bin



1246-96



**K. MIDNIGHT BAMBOO  
CYLINDER DISPLAYS**

Cylinders Sold Separately.

ITEM 1425-3-96 | 16Wx5½Dx6H - 3 Cylinder

ITEM 1425-6-96 | 16Wx11Dx6H - 6 Cylinder



K

**L. MIDNIGHT BAMBOO 3 TIER  
CYLINDER DISPLAY**

Cylinders Sold Separately.  
Use for Condiments or Flatware.

ITEM 1016-3-96 | 6¼Wx9½Dx22¾H

**OPTIONAL CYLINDERS**

Available in Six Colors.  
Stainless Steel Style: Perforated (39), (SOLID).  
Colored Melamine: Black (13), White (15),  
Butter Yellow (61), Terra Cotta (62), Sage (63),  
Cranberry (64). Extra Deep: White (8-15).

ITEM 1017-39 | 4½DIAx5½H

ITEM 1017-SOLID | 4½DIAx5½H

ITEM 1017 | 4½DIAx5½H

ITEM 1017-8-15 | 4½DIAx8H - Extra Deep



L

Please visit [www.calmil.com/legal](http://www.calmil.com/legal) for a complete list of California Proposition 65 related items.



# MIDNIGHT BAMBOO collection

A



B



C



D



Now a reversible design for self or attendant serve! Featuring 3 different tray positions: tilted front, tilted back, and level.

## A. MIDNIGHT BAMBOO BREAD DISPLAY

ITEM 3624-96 | 20 $\frac{1}{4}$ Wx12 $\frac{3}{4}$ Dx13 $\frac{1}{4}$ H

## B. MIDNIGHT BAMBOO EURO DISPLAY CASE

Dimensions: 17Wx17Dx18H.

Includes 3 – 10" x 14" Black Acrylic Trays.

ITEM P255-96 | Attendant Serve

ITEM P255-96S | Self-Serve

ITEM 335-10-13 | Replacement Tray

## C. MIDNIGHT BAMBOO BREAD CASE

Drawers Made with Green Glass Acrylic.

ITEM 813-96 | 15Wx14 $\frac{1}{2}$ Dx15H

ITEM 813-96DRAWER | Replacement Drawer

## D. MIDNIGHT BAMBOO DISPLAY CASE

Dimensions: 21 $\frac{3}{4}$ Wx16 $\frac{1}{4}$ Dx21 $\frac{1}{2}$ H.

Includes 3 – 13" x 18" Black Acrylic Trays.

Self and Attendant Serve with 3 Tray Positions.

ITEM 284-96 | 21 $\frac{3}{4}$ Wx16 $\frac{1}{4}$ Dx21 $\frac{1}{2}$ H

ITEM 325-13-13 | Replacement Tray

Please visit [www.calmil.com/legal](http://www.calmil.com/legal) for a complete list of California Proposition 65 related items.



**E. MIDNIGHT BAMBOO SINGLE AIRPOT STAND WITH PACKET DRAWER**  
Drip Tray Included. Airpot Not Included.  
1051-1-96 | 8¼Wx12¾Dx6¼H

**F. MIDNIGHT BAMBOO DUAL AIRPOT DISPLAY**  
2 Drip Trays Included.  
Airpots Not Included.  
ITEM 360-2-96 | 7½Wx23½Dx15¼H

**G. MIDNIGHT BAMBOO DISPENSER W/DECORATIVE INFUSION WALL**  
3 Gallon Capacity. Includes Drip Tray.  
ITEM 3697-3-96 | 8¼Wx9¾Dx25¾H

**H. 3 SHELF SILVER FRAME RISER**  
1940-96 | 28Wx12Dx24H



Please visit [www.calmil.com/legal](http://www.calmil.com/legal) for a complete list of California Proposition 65 related items.



# WESTPORT collection



A



B



C



D

## A. WESTPORT BEVERAGE DISPENSERS

1.5 and 3 Gallon Capacity. Includes Drip Tray.

### ICE CHAMBER

ITEM 1527-1-52 | 8¼Wx9¼Dx17¾H

ITEM 1527-3-52 | 8¼Wx9¼Dx25¾H

### INFUSION CHAMBER

ITEM 1527-1INF-52 | 8¼Wx9¼Dx17¾H

ITEM 1527-3INF-52 | 8¼Wx9¼Dx25¾H

## C. WESTPORT CUT-MATE®

### HIGH HEAT CARVING STATIONS

Specify Color: Westport (52), Light Wood (53).

ITEM 810 | 22Wx18Dx4H

## B. WESTPORT EURO DISPLAY CASE

Includes 3 – 10" x 14" Black Trays.

ITEM P255-52 | 17Wx17Dx18H - Attendant Serve

ITEM P255-52S | 17Wx17Dx18H - Self-Serve

ITEM 335-10-13 | Replacement Tray

## D. WESTPORT ICE HOUSINGS

Includes Clear Polycarbonate Pan.

ITEM 412-12-52 | 12Wx20Dx8H

ITEM 412-18-52 | 18Wx26Dx8H

Please visit [www.calmil.com/legal](http://www.calmil.com/legal) for a complete list of California Proposition 65 related items.

# WESTPORT collection



**A TIMELESS CLASSIC**, this collection is comprised of beautiful wood with a mahogany finish. Each piece creates an inviting sense of warmth and comfort while continuing to provide the structural integrity Cal-Mil is known for, making this the perfect line to create a reminiscent-of-home type atmosphere.



# WESTPORT collection

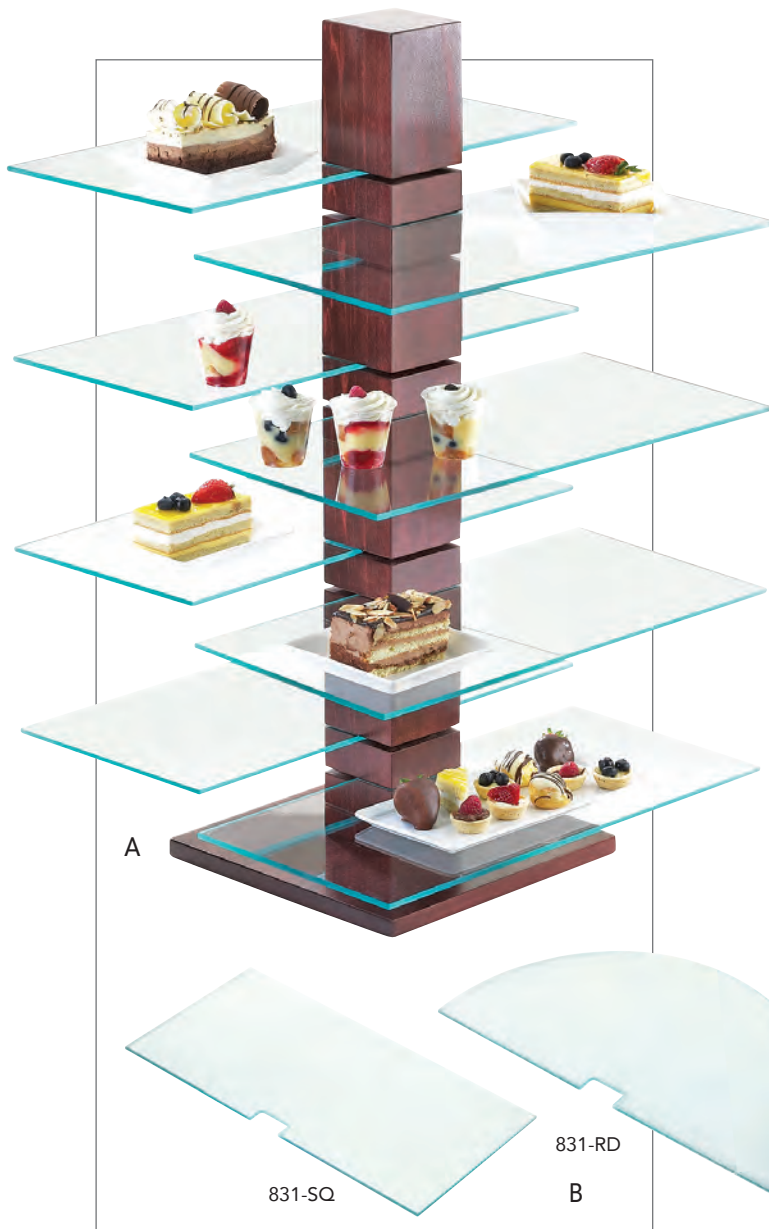

## A. WESTPORT PILLAR RISER AND SHELVES

Shelves Sold Separately.

ITEM 791-52 | 9Wx9Dx32½H

## B. GLASS SHELVES (SOLD SEPARATELY)

ITEM 831-SQ | 19¾Wx10Dx¼H

ITEM 831-RD | 19¾Wx10Dx¼H

ITEM C732GLASS | 32Wx7Dx¼H



## C. WESTPORT WET FLOOR SIGNS

Two-Sided.

ITEM 851-WET | 12Wx17½Dx20H

ITEM 852-52 | 12Wx17½Dx22H



## D. WESTPORT BUTANE STOVE FRAME

Iwatani Model 35FW Not Included.

ITEM 1556-52 | 14Wx14½Dx7½H

ITEM 4010-I | Optional Butane Stove

Please visit [www.calmil.com/legal](http://www.calmil.com/legal) for a complete list of California Proposition 65 related items.



Now a reversible design for self or attendant serve! Featuring 3 different tray positions: tilted front, tilted back, and level.

**E. WESTPORT DISPLAY CASE**

Includes 3 – 13" x 18" Black Acrylic Trays.  
Self and Attendant Serve with 3 Tray Positions.  
ITEM 815-52 | 21Wx16¼Dx18¼H  
ITEM 325-13-13 | Replacement Tray

**F. WESTPORT DISPLAY CASE**

Includes 3 – 13" x 18" Black Acrylic Trays.  
Self and Attendant Serve with 3 Tray Positions.  
ITEM 284-52 | 21¼Wx18½Dx20¼H  
ITEM 325-13-13 | Replacement Tray

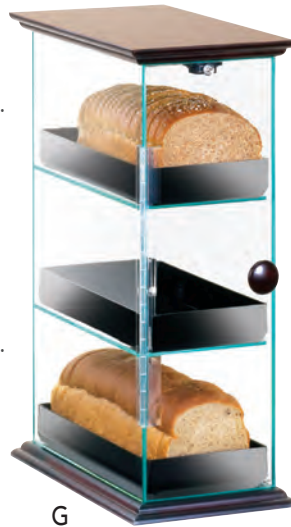

G



H

**G. WESTPORT BREAD DISPLAY**

ITEM 1204-52 | 8Wx13Dx21H  
ITEM 1204DRAWER-13 | Replacement Drawer

**H. WESTPORT BREAD DISPLAY CASE**

ITEM 813-52 | 16½Wx15Dx15¼H  
ITEM 813-52DRAWER | Replacement Drawer



I

**I. WESTPORT DRIP TRAY**

ITEM 330-6-52 | 6Wx6Dx1H

**J. WESTPORT CUBE RISERS**

Complete Set of 3 Risers.  
Sizes: 9" Square, 7" Square, and 5" Square.  
ITEM 1915 | Set of 3



J

Please visit [www.calmil.com/legal](http://www.calmil.com/legal) for a complete list of California Proposition 65 related items.



# IRON collection

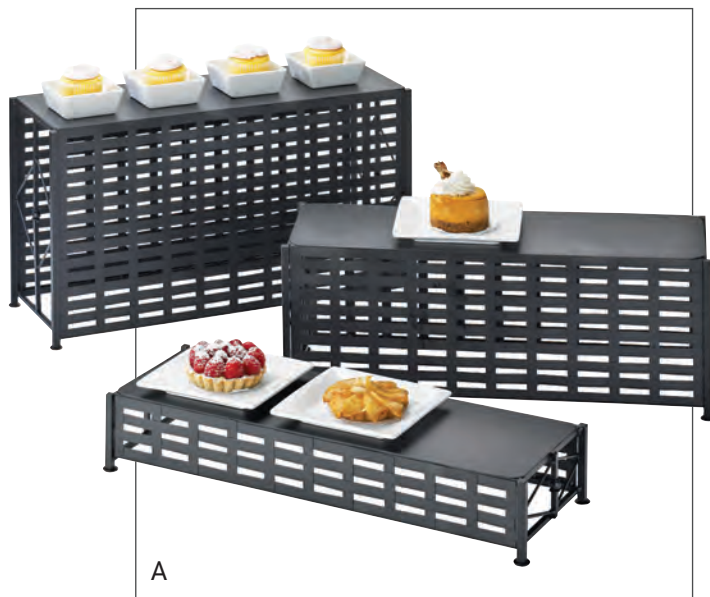

A



B

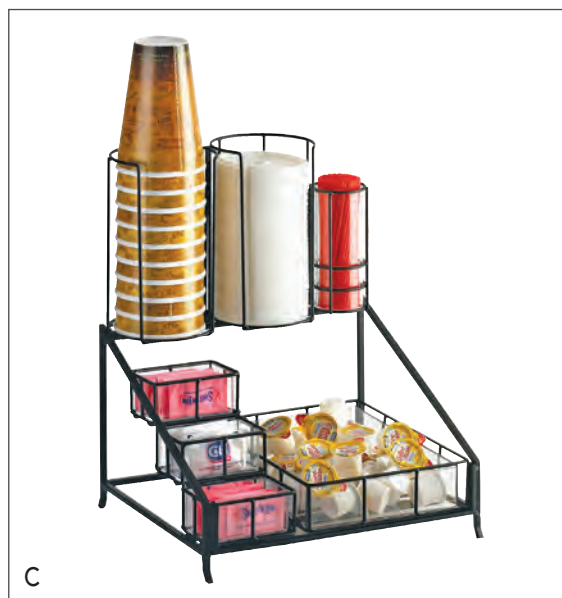

C



D

## A. IRON RISERS

ITEM 1247-3 | 21Wx7½Dx3¾H

ITEM 1247-7 | 21Wx7½Dx6½H

ITEM 1247-11 | 21Wx7½Dx11½H

## C. IRON COFFEE CONDIMENT DISPLAY

Holds up to 3.75" Diameter Cups & Lids.

ITEM 1453 | 12Wx10½Dx14½H

## B. IRON CURVED FRONT DISPLAY CASE

Curved Front with 3 Doors. Self Serve.  
Includes 3 Clear Trays.

ITEM 1708-1014 | 16Wx15Dx17¼H - 10x14 Tray

ITEM 1708-1318 | 18Wx16Dx21H - 13x18 Tray

### REPLACEMENT TRAYS

ITEM 335-10-12 | 10x14 Replacement Tray

ITEM 325-13-12 | 13x18 Replacement Tray

## D. IRON CHAFER ALTERNATIVE

ITEM 1361-12 | 10¼Wx10Dx7½H

ITEM 1361-22 | 19¾Wx10Dx7½H

ITEM 3067 | Optional Griddle w/ Heat Guard Handles

ITEM 1362 | Optional Griddle w/ Brackets

Please visit [www.calmil.com/legal](http://www.calmil.com/legal) for a complete list of California Proposition 65 related items.

# IRON

collection



**DISTINCT AND DEFINED**, this collection takes a minimalistic approach to high quality tableware. This line features sleek and simple metal frameworks that leave room for creativity to thrive.



# IRON collection



A



B



C



D



E

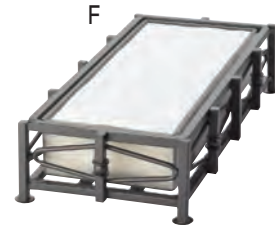

F

## A. 3 LEVEL PASTRY CASE

Includes Case and Set of 13" x 18" Trays.  
Available Only in Black.

ITEM PC300 | 20Wx16Dx24H

ITEM GL1620-C | Replacement Tray

## D. 3 TIER ROUND BOWL STAND

Frame Only, Bowls Sold Separately.

ITEM C1222-8 | 8Wx16Dx18H | Black

ITEM C1222-10 | 10Wx18Dx18H | Black

ITEM C1223-8 | 8Wx16Dx18H | Chrome

ITEM C1223-10 | 10Wx18Dx18H | Chrome

## ROUND MELAMINE BOWLS

Specify Color: Black (13), White (15).

ITEM 418-8 | 8" Round Bowl

ITEM 418-10 | 10" Round Bowl

## B. IRON STRAIGHT FRONT DISPLAY CASE

Straight Front for Self or Attendant Serve.

Includes 3 Clear Trays.

ITEM 1735-1318 | 19Wx15Dx21¼H

## REPLACEMENT TRAYS

ITEM 325-13-12 | 13x18 Replacement Tray

## E. IRON CONDIMENT ORGANIZER

ITEM 1252 | 8½Wx6¾Dx4H

## C. IRON BEVERAGE DISPENSER

1.5 and 3 Gallon Capacity.  
Drip Tray and Ice Chamber Included.  
Specify Glass or Acrylic.

ITEM 1112-1-13 | 7Wx9Dx19H | Glass

ITEM 1112-3-13 | 7Wx9Dx26½H | Glass

ITEM 1112-1A-13 | 7Wx9Dx19H | Acrylic

ITEM 1112-3A-13 | 7Wx9Dx26½H | Acrylic

## F. IRON NAPKIN HOLDER

ITEM 1253 | 4X8 Napkin Size

Please visit [www.calmil.com/legal](http://www.calmil.com/legal) for a complete list of California Proposition 65 related items.

**G. IRON 3 LEVEL DISPLAYS**

Covers Do Not Work on These Units.  
Frame Only, Plates Not Included.  
Specify Frame Color: Black (13), Chrome (49).

ITEM 977-8 | 8¾Wx8¾Dx18H

ITEM 977-10 | 11¾Wx11¾Dx20H



G



**H. IRON NAPKIN & PLATE DISPLAY**

ITEM 1455 | 9½Wx14Dx10H

**I. IRON CUP & LID DISPLAY**

Holds up to 3.75" Diameter Cups & Lids.

ITEM 1452 | 8Wx12Dx15H

**J. IRON PLATE AND UTENSIL HOLDER NEW**

ITEM 22079-13 | 11Wx20¼Dx5½H

**K. IRON SIGNAGE**

ITEM 1262 | 3½Wx2H

ITEM 1264 | 8½Wx11H



H



I

**L. IRON CUP & LID ORGANIZER**

Holds up to 3.75" Diameter Cups & Lids.

ITEM 3036-13 | 4½Wx11½Dx11½H

**M. IRON CUP & LID HOLDER**

Holds up to 3.75" Diameter Cups & Lids.

ITEM 1238 | 4¼Wx4¼Dx8¼H

ITEM 1239 | 4¼Wx4¼Dx8¼H



J

**N. IRON BOWL & PLATE HOLDER**

ITEM 1236 | 9½Wx9½Dx6½H

ITEM 1237 | 6½Wx6½Dx8H



K



L



1238



M

1239



1237



N

1236

Please visit [www.calmil.com/legal](http://www.calmil.com/legal) for a complete list of California Proposition 65 related items.



# MISSION collection



A



B

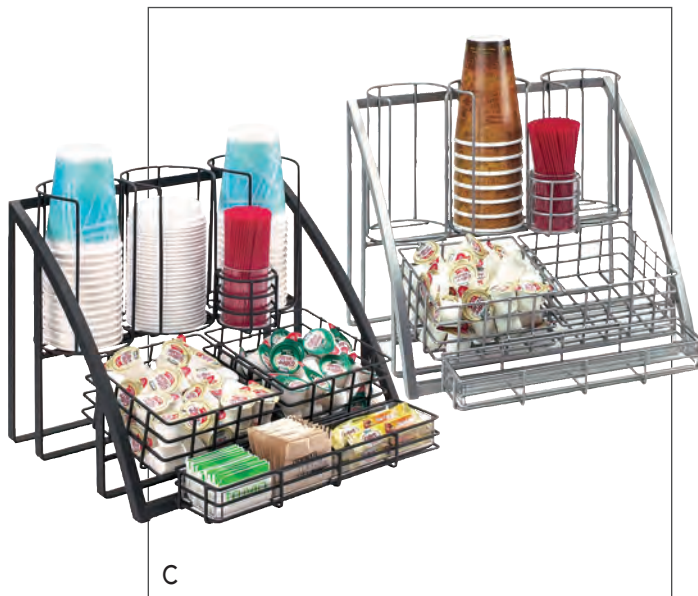

C



D

## A. MISSION SQUARE BEVERAGE DISPENSERS

1.5 and 3 Gallon Capacity.  
Powder Coated Metal Base.

ITEM 1112-1-13 | 7Wx9Dx19H - Glass

ITEM 1112-3-13 | 7Wx9Dx26½H - Glass

ITEM 1112-1A-13 | 7Wx9Dx19H - Acrylic

ITEM 1112-3A-13 | 7Wx9Dx26½H - Acrylic

## C. MISSION CONDIMENT ORGANIZER

Holds up to 3¾" Diameter Cups & Lids.  
Specify Color: Black (13), Platinum (39).

ITEM 1715 | 15Wx14Dx12H

## B. MISSION CHAFER

Includes Stainless Steel Cover.

ITEM 1368-13 | 21¾Wx13¾Dx15¼H

ITEM 3325-55 | Replacement Cover

## D. MISSION 2 TIER JAR DISPLAY

Includes Glass Jars.  
Specify Color: Black (13), Platinum (39).

ITEM 1723 | 14Wx9Dx7H

ITEM C4X4GLCN | Replacement Glass Jar

Please visit [www.calmil.com/legal](http://www.calmil.com/legal) for a complete list of California Proposition 65 related items.



# MISSION collection



**BOLD AND DISTINCT PILLARED FRAMES** shape this collection, offering a design inspired by columns within historical architecture. Constructed of durable black metal, these unique pieces are perfect for making a statement presentation.



# MISSION collection



A

## A. MISSION ICE HOUSING

Includes Clear Polycarbonate Pan.

ITEM 1365-12-13 | 22Wx14Dx8½H

ITEM 1365-18-13 | 28Wx20Dx8½H



B

## B. MISSION TURN & SERVE CEREAL DISPENSER

4.5 Liter Capacity Per Cylinder.

Features Turn & Serve Mechanism.

ITEM 3597-3-13 | 19½Wx10½Dx26H



C

## C. MISSION TOAST BAR

Includes 6 White Melamine Jars,

1 Maple Cutting Board, and 1 Slate Insert.

ITEM 3455 | 28½Wx12½Dx9¾H

Please visit [www.calmil.com/legal](http://www.calmil.com/legal) for a complete list of California Proposition 65 related items.



D

**D. MISSION CHAFER ALTERNATIVES**

ITEM | 1360-12-13 | 10¼Wx10Dx7½H

ITEM | 1364-12-13 | 10¼Wx10Dx5H

ITEM | 1360-22-13 | 19¾Wx10Dx7½H

ITEM | 1364-22-13 | 19¾Wx10Dx4H



E



F

**E. OPTIONAL GRIDDLE WITH BRACKETS**

Designed to Fit 1360-22-13 and 1364-22-13 Only.

ITEM 1362 | 22¾Wx13¾Dx2¼H

**F. GRIDDLE W/ HEAT GUARD HANDLES**

Designed to Fit 1360-22-13 and 1364-22-13 Only.

ITEM 3067 | 22¾Wx13¾Dx2¼H



G

**G. MISSION BUTANE STOVE FRAME**

Iwatani Model 35FW Not Included.

ITEM 1363-13 | 14Wx12Dx7H

ITEM 4010-I | Optional Butane Stove



H

**H. MISSION INDUCTION FRAME**

Induction Unit Not Included. 1414-S Fits Spring SR-261C. 1414-V Fits Volrath 59500.

ITEM 1414-S-13 | 13¾Wx16½Dx7H

ITEM 1414-V-13 | 14¾Wx16½Dx7H

Please visit [www.calmil.com/legal](http://www.calmil.com/legal) for a complete list of California Proposition 65 related items.



# MISSION collection

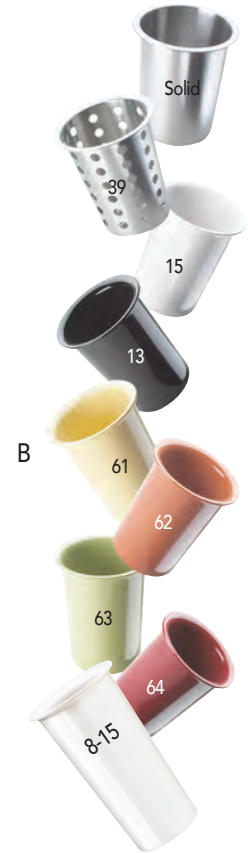
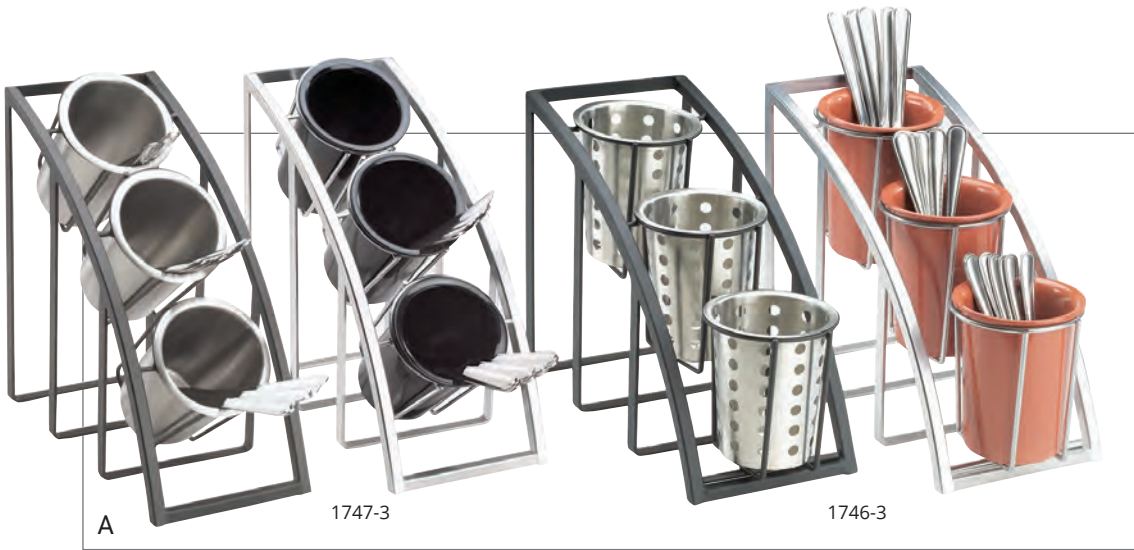

## A. MISSION SLOPED & VERTICAL DISPLAYS

Cylinders Sold Separately.  
Specify Frame Color: Black (13), Platinum (39).  
ITEM 1746-3 | 7Wx13Dx10¾H  
ITEM 1747-3 | 7Wx13Dx13H

## B. OPTIONAL CYLINDERS

Available in Six Colors.  
Stainless Steel Style: Perforated (39), (SOLID).  
Colored Melamine: Black (13), White (15),  
Butter Yellow (61), Terra Cotta (62), Sage (63),  
Cranberry (64). Extra Deep: White (8-15).  
ITEM 1017-39 | 4½DIAx5½H  
ITEM 1017-SOLID | 4½DIAx5½H  
ITEM 1017 | 4½DIAx5½H  
ITEM 1017-8-15 | 4½DIAx8H | Extra Deep



## C. MELAMINE BOWLS

Specify Color: Black (13), White (15).  
ITEM 418-8 | 8" Round Bowl  
ITEM 418-10 | 10" Round Bowl  
ITEM SR262 | 10" Square White Bowl

## D. ENAMELWARE MELAMINE BOWLS

ITEM 3343-8-15 | 8¼DIAx3¾H  
ITEM 3343-10-15 | 10¾DIAx5H



## E. MISSION ROUND BOWL STAND

8" and 10" Bowls Sold Separately.  
ITEM 1712-8-13 | 10½Wx15½Dx15½H | Fits 8" Bowls  
ITEM 1712-10-13 | 12Wx19Dx17½H | Fits 10" Bowls



## F. MISSION SQUARE BOWL STAND

Square Melamine Bowls Sold Separately.  
ITEM 1750-13 | 12Wx19Dx13½H  
ITEM SR262 | 10" Square White Bowl

Please visit [www.calmil.com/legal](http://www.calmil.com/legal) for a complete list of California Proposition 65 related items.



**G. MISSION DUAL AIRPOT STAND**  
 Airpots Not Included.  
 ITEM 1704-13 | 8Wx22Dx15H



**H. MISSION WIRE MERCHANDISER**  
 ITEM 1702-13 | 13½Wx15Dx16½H



**I. MISSION MERCHANDISER STAND**  
 Frame Only, Bamboo Tray (Shown) Sold Separately. Tray Sizes: 19¾Wx11¼Dx1¼H.

ITEM 1722 | 23Wx13Dx15H

**OPTIONAL TRAYS**

ITEM 1367-12-60 | Bamboo Tray

ITEM 1367-12-99 | Reclaimed Wood Tray



**J. MISSION SHELF RISER**  
 ITEM 1254 | 24Wx12Dx24H

Please visit [www.calmil.com/legal](http://www.calmil.com/legal) for a complete list of California Proposition 65 related items.



# LUXE collection



A



B



C



D

## A. LUXE ACRYLIC BEVERAGE DISPENSER

3 Gallon Capacity. Includes Drip Tray.  
Stainless Steel Trim (55).

### ICE CHAMBER

ITEM 3002-3-55 | 7¾Wx7¾Dx25¾H

### INFUSION CHAMBER

ITEM 3002-3INF-55 | 7¾Wx7¾Dx25¾H

## B. LUXE CHAFER

Includes Stainless Steel Chafers Cover.  
Stainless Steel Trim (55).

ITEM 3017-55 | 21¾Wx13¾Dx12H

ITEM 3325-55 | Replacement Cover

## C. LUXE CHAFER ALTERNATIVE

Includes Wire Grill and Fuel Cell Rail with Windguard.  
Stainless Steel Trim (55).

ITEM 3011-55 | 10¾Wx10Dx8¾H

ITEM 3012-55 | 19¾Wx10Dx8½H

## D. LUXE ICE HOUSINGS

Includes Clear Polycarbonate Pan.  
Stainless Steel Trim (55).

ITEM 3005-10-55 | 10Wx12¼Dx6½H

ITEM 3005-12-55 | 12¼Wx20¼Dx6¼H

Please visit [www.calmil.com/legal](http://www.calmil.com/legal) for a complete list of California Proposition 65 related items.

# LUXE collection



A CONTEMPORARY TAKE ON LUXURY, this collection combines white metal and brushed stainless steel. Exemplifying true elegance, this line can transform any presentation from ordinary to exceptional.



# LUXE collection



A



B

**A. LUXE BUTANE STOVE FRAME**  
Iwatani Model 35FW Not Included.  
Stainless Steel Trim (55).

ITEM 3023-55 | 12Wx14¼Dx7½H

ITEM 4010-I | Optional Butane Stove

**B. LUXE SIGNAGE & MENU HOLDER**  
Stainless Steel Trim (55).

ITEM 3016-811-55 | 8½Wx11H



C



D

**C. LUXE REVOLVING CUP/LID ORGANIZER**

Holds Cups and Lids up to 3.75" Diameter.

Stainless Steel Trim (55).

ITEM 3001-55 | 8¼Wx8¼Dx19H

**D. LUXE THREE TIER BREAD DISPLAY**

Includes 3 White Trays.

Stainless Steel Trim (55).

ITEM 3021-55 | 7Wx14Dx20¼H

**E. LUXE VERTICAL CYLINDER DISPLAY**

Cylinders Sold Separately.

Stainless Steel Trim (55).

ITEM 3010-55 | 6¾Wx7½Dx20¼H



E



**OPTIONAL CYLINDERS**

Available in Six Colors.

Stainless Steel Style:

Perforated (39), (SOLID).

Colored Melamine: Black (13), White (15),

Butter Yellow (61), Terra Cotta (62), Sage

(63), Cranberry (64).

Extra Deep: White (8-15).

ITEM 1017-39 | 4½DIAx5½H

ITEM 1017-SOLID | 4½DIAx5½H

ITEM 1017 | 4½DIAx5½H

ITEM 1017-8-15 | 4½DIAx8H | Extra Deep

Please visit [www.calmil.com/legal](http://www.calmil.com/legal) for a complete list of California Proposition 65 related items.



**F. LUXE TURN & SERVE  
CEREAL DISPENSER**  
4.5 Liter Capacity Per Cylinder.  
Stainless Steel Trim (55).  
ITEM 3598-3-55 | 20½Wx7¼Dx27H



**G. LUXE THREE STEP  
BREAD CASE DISPLAY**  
Includes 3 – 13x18 White Trays.  
Stainless Steel Trim (55).  
ITEM 3020-55 | 19Wx20Dx19H  
ITEM 325-13-15 | Replacement Tray



**H. LUXE RECTANGULAR RISERS**  
Stainless Steel Trim (55).  
ITEM 3025-55 | 12Wx20Dx6½H  
ITEM 3026-55 | 12Wx10Dx6½H



**I. LUXE MULTI-LEVEL 4 BOWL DISPLAY**  
Includes 4 Melamine Bowls.  
Stainless Steel Trim (55).  
ITEM 3024-55 | 20Wx16Dx13½H  
ITEM SR261 | Replacement Bowl

Please visit [www.calmil.com/legal](http://www.calmil.com/legal) for a complete list of California Proposition 65 related items.



# LUXE collection



A



B



C



D



E



F

3614-55CL



G



H

## A. SQUARE STAINLESS STEEL COLD SAMPLER ❄️

Includes Plate, Flip Lid, Cold Packs and Liner to Keep Contents Cold. Stainless Steel Trim (55).

ITEM 3329-12-55 | 12Wx13Dx7½H

ITEM CC3329 | Replacement Packs & Liner

## B. ROUND BASE FLIP LID CHILL SAMPLER ❄️

Includes Plate, Flip Lid, Cold Packs and Liner to Keep Contents Cold. Stainless Steel Trim (55).

ITEM 3328-12-55 | 12DIAx7½H

ITEM CC3328 | Replacement Packs & Liner

## C. LUXE CHILLED MIXOLOGY STANDS

Complete Set Includes Base and 3 Jars with Cold Pucks. Stainless Steel Trim (55). Specify Lid Type.

ITEM 3492-4-15 | 16Wx6Dx4H | Solid Lids

ITEM 3492-4-15HL | 16Wx6Dx4H | Hinged Lids

ITEM 3492-4-15NL | 16Wx6Dx4H | Notched Lids

## D. LUXE FLATWARE ORGANIZER

Stainless Steel Trim (55).

ITEM 3015-55 | 8¼Wx5¼Dx6H

## E. LUXE TABLETOP TRASH BIN

Constructed of Bamboo and Stainless Steel.

ITEM 1717-15 | 5Wx5Dx7H

## F. POLYCARBONATE CARAFES

Stainless Steel Pour Spout.

OPEN TOP LID

ITEM 3614-55 | 1 Liter

ITEM 3551-55 | 1.5 Liter

HINGED CLOSING LID

3614-55CL | 1 Liter

3551-55CL | 1.5 Liter

## G. LUXE THREE COMPARTMENT CONDIMENT ORGANIZER

Stainless Steel Trim (55).

ITEM 3014-55 | 9¼Wx4½Dx2½H

## H. LUXE MULTI-SECTION CONDIMENT ORGANIZER

Stainless Steel Trim (55).

ITEM 3009-55 | 12¼Wx12¼Dx6½H

Please visit [www.calmil.com/legal](http://www.calmil.com/legal) for a complete list of California Proposition 65 related items.



**I. LUXE BREAD DISPLAY**  
Stainless Steel Trim (55).  
ITEM 3927-55 | 6¾Wx12¼Dx6¾H



**J. LUXE NINE JAR CONDIMENT DISPLAY**  
Jars Included.  
Dimensions: 12¼Wx9Dx15½H  
Stainless Steel Trim (55).  
ITEM 3018-55-12 | w/ 9 Glass Jars  
ITEM 3018-55-15 | w/ 9 White Melamine Jars  
**REPLACEMENT JARS**  
ITEM C4X4GLCN | Glass Jars  
ITEM C1432BODY | White Melamine Jars



**K. LUXE STAIR STEP JAR DISPLAY**  
Specify Jar. Stainless Steel Trim (55).  
ITEM 3003-55-12 | w/ 3 Glass Jars  
4½Wx12¼Dx9H  
ITEM 3003-55-15 | w/ 3 White Melamine Jars  
4½Wx12¼Dx9H



**L. LUXE TWO STEP AIRPOT STAND**  
Airpots Not Included.  
Drip Trays Included.  
Stainless Steel Trim (55).  
ITEM 3008-55 | 7Wx22½Dx12½H



**M. LUXE THREE BOWL DISPLAY**  
Includes Three White 8" Melamine Square Bowls.  
Stainless Steel Trim (55).  
ITEM 3022-55 | 10Wx16¼Dx17H  
ITEM SR261 | Replacement Bowl



**N. LUXE TWO STEP ICE HOUSING DISPLAY**  
Includes 2 White Melamine 1/6 Housings.  
Stainless Steel Trim (55).  
ITEM 3004-55 | 7Wx12¾Dx8H  
ITEM 475-6-15 | Replacement Ice Housing

Please visit [www.calmil.com/legal](http://www.calmil.com/legal) for a complete list of California Proposition 65 related items.



# URBAN collection



A



B



C



D

## A. URBAN BEVERAGE DISPENSER

3 Gallon Capacity. Includes Chamber and Drip Tray.  
Stainless Steel (55).

### ICE CHAMBER

ITEM 3394-3-55 | 8Wx8Dx24H

### INFUSION CHAMBER

ITEM 3394-3INF-55 | 8Wx8Dx24H

## C. URBAN BREAD DRAWERS

Stackable.  
Stainless Steel (55).

ITEM 3410-55 | 6¾Wx12¼Dx6¾H

## B. URBAN CASE DISPLAY

Includes 3 — 13" x 18" Clear Trays.  
Stainless Steel (55).

ITEM 3413-55 | 19¼Wx14¼Dx19¼H

ITEM 325-13-12 | Replacement Tray

## D. URBAN ICE HOUSINGS

Includes Clear Polycarbonate Pan.  
Stainless Steel (55).

ITEM 3395-10-55 | 12¾Wx10¾Dx6¾H

ITEM 3395-12-55 | 20¾Wx12¾Dx7¼H

Please visit [www.calmil.com/legal](http://www.calmil.com/legal) for a complete list of California Proposition 65 related items.



# URBAN collection



A CONTEMPORARY TAKE ON INDUSTRIAL DESIGN, this collection showcases bright stainless steel accented with dramatic rivets. The striking metal pairs well with mixed materials and can be softened by being paired with any of our wood products.



# URBAN collection



A

B

## A. URBAN CHAFER ALTERNATIVES

Stainless Steel (55)

ITEM 3407-55 | 10 $\frac{1}{4}$ Wx10Dx8 $\frac{1}{4}$ H

ITEM 3391-55 | 19 $\frac{3}{4}$ Wx10Dx9 $\frac{1}{2}$ H



C

## B. URBAN BUTANE STOVE FRAME

Iwatani Model 35FW Not Included.  
Stainless Steel (55).

ITEM 3390-55 | 14Wx12 $\frac{1}{2}$ Dx7 $\frac{1}{4}$ H

ITEM 4010-I | Option Butane Stove



D

## C. URBAN LARGE CONDIMENT ORGANIZER

Stainless Steel (55).

ITEM 3409-55 | 12Wx12Dx4H

E



## D. URBAN PACKET AND CONDIMENT ORGANIZER

Stainless Steel (55).

ITEM 3398-55 | 8 $\frac{3}{4}$ Wx6Dx3 $\frac{1}{4}$ H

## E. URBAN FLATWARE ORGANIZER

Stainless Steel (55).

ITEM 3408-55 | 9Wx6Dx5 $\frac{1}{4}$ H

Please visit [www.calmil.com/legal](http://www.calmil.com/legal) for a complete list of California Proposition 65 related items.

**F. URBAN CEREAL DISPENSER**

Features Turn & Serve Mechanism.  
4.5 Liter Capacity Per Cylinder.  
Stainless Steel (55).

ITEM 3626-55 | 18¼Wx10¼Dx27H



**G. URBAN CYLINDER DISPLAY**

Cylinders Sold Separately.  
Stainless Steel (55).

ITEM 3411-55 | 6¾Wx7½Dx20¼H



**OPTIONAL CYLINDERS**

Available in Six Colors.  
Stainless Steel Style: Perforated (39), (SOLID).  
Colored Melamine: Black (13), White (15),  
Butter Yellow (61), Terra Cotta (62), Sage (63),  
Cranberry (64). Extra Deep: White (8-15).

ITEM 1017-39 | 4½DIAx5½H

ITEM 1017-SOLID | 4½DIAx5½H

ITEM 1017 | 4½DIAx5½H

ITEM 1017-8-15 | 4½DIAx8H - Extra Deep



**H. URBAN REVOLVING  
CUP/LID ORGANIZER**

Fits Cups and Lids Up to 3.75"  
Stainless Steel (55).

ITEM 3393-55 | 7¾Wx7¾Dx18H

**I. SQUARE STAINLESS STEEL  
COLD SAMPLER ❄️**

Includes Plate, Flip Lid, Cold Packs  
and Liners to Keep Contents Cold.

ITEM 3329-12-55 | 12Wx13Dx7½H

ITEM CC3329 | Replacement Cold Pack & Liner





# SQUARED collection



A



B



C



D

## A. SQUARED ACRYLIC BEVERAGE DISPENSERS

1.5 and 3 Gallon Capacities. Includes Drip Tray.  
Specify Color: Black (13), Stainless Steel (55).

### ICE CHAMBER

ITEM 1602-1 | 7½Wx9½Dx17¾H

ITEM 1602-3 | 7½Wx9½Dx25¾H

### INFUSION CHAMBER

ITEM 1602-1INF | 7½Wx9½Dx17¾H

ITEM 1602-3INF | 7½Wx9½Dx25¾H

## C. SQUARED ICE HOUSING

Includes Clear Polycarbonate Bin.  
Black (13), Stainless Steel (55).

ITEM 1603-12-13 | 21Wx12½Dx6½H

ITEM 1603-12-55 | 21Wx12½Dx6½H

## B. SQUARED REVOLVING CUP AND LID DISPENSER

Hold Cups and Lids Up to 3.75" in Diameter.  
Black (13), Stainless Steel (55).

ITEM 1615-13 | 8¼Wx8¼Dx18¼H

ITEM 1615-55 | 8¼Wx8¼Dx18¼H

## D. SQUARED BUTANE STOVE FRAMES

Iwatani Model 35FW Not Included.  
Black (13), Stainless Steel (55).

ITEM 1617-13 | 13Wx11Dx6H

ITEM 1617-55 | 13Wx11Dx6H

ITEM 4010-I | Optional Butane Stove

Please visit [www.calmil.com/legal](http://www.calmil.com/legal) for a complete list of California Proposition 65 related items.



# SQUARED

collection



**STATE-OF-THE-ART METALWORK** offered in both dramatic black and stainless steel. This collection was designed to stand out among the noise by drawing eyes directly to your presentation. Made from high quality stainless steel, the Squared Collection is equally aesthetic and functional.



# SQUARED collection



A



B

## A. SQUARED 3 STEP JAR DISPLAYS

Includes 3 Glass Jars.  
Black (13), Stainless Steel (55).  
ITEM 1604-13 | 4Wx12Dx10½H  
ITEM 1604-55 | 4Wx12Dx10½H  
ITEM C4X4GLCN | Replacement Jar

## B. SQUARED VERTICAL CYLINDER DISPLAYS

Cylinders Sold Separately.  
Stainless Steel (55).  
ITEM 1605-55 | 5Wx8Dx20½H

## C. SQUARED STAINLESS NAPKIN HOLDER

ITEM 1606-55 | Napkin Size 4Wx8H

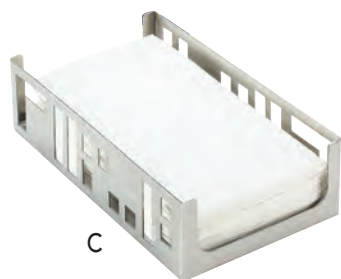

C



D

## D. SQUARED PACKET ORGANIZERS

Stainless Steel (55).  
ITEM 1611-55 | 9½Wx4½Dx2H

## E. SQUARED STAINLESS CYLINDER DISPLAY

Cylinders Sold Separately. Use for Condiments or Flatware! 1017-8-15 Will Not Fit This Display.  
ITEM 1608-55 | 16Wx5¼Dx6H



E



## OPTIONAL CYLINDERS

Available in Six Colors.  
Stainless Steel Style: Perforated (39), (SOLID).  
Colored Melamine: Black (13), White (15),  
Butter Yellow (61), Terra Cotta (62), Sage (63),  
Cranberry (64). Extra Deep: White (8-15).

ITEM 1017-39 | 4½DIAx5½H

ITEM 1017-SOLID | 4½DIAx5½H

ITEM 1017 | 4½DIAx5½H

ITEM 1017-8-15 | 4½DIAx8H | Extra Deep

## F. SQUARED CONDIMENT ORGANIZERS

Black (13), Stainless Steel (55).  
ITEM 1616-13 | 12Wx12Dx5¼H  
ITEM 1616-55 | 12Wx12Dx5¼H



F

Please visit [www.calmil.com/legal](http://www.calmil.com/legal) for a complete list of California Proposition 65 related items.

**G. SQUARED CHAFER ALTERNATIVE**

Has Built In Windguards.  
Black (13), Stainless Steel (55).

ITEM 1612-12-13 | 10¼Wx10Dx7½H

ITEM 1612-12-55 | 10¼Wx10Dx7½H

ITEM 1612-22-13 | 19¾Wx10Dx7½H

ITEM 1612-22-55 | 19¾Wx10Dx7½H

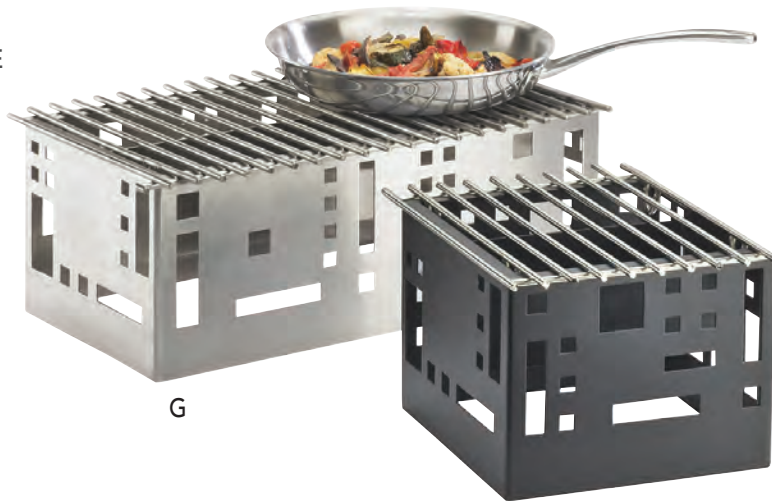

G

**H. SQUARED CHAFER**

Includes Stainless Steel Chafer Cover.  
Black (13), Stainless Steel (55).

ITEM 1613-13 | 23Wx15Dx16H

ITEM 3325-55 | Replacement Cover



H

**I. SQUARED CUBE RISERS**

Glass Tops Not Included.  
Black (13), Stainless Steel (55).

ITEM 1607-5-13 | 5Wx5Dx5H

ITEM 1607-5-55 | 5Wx5Dx5H

ITEM 1607-7-13 | 7Wx7Dx7H

ITEM 1607-7-55 | 7Wx7Dx7H

ITEM 1607-9-13 | 9Wx9Dx9H

ITEM 1607-9-55 | 9Wx9Dx9H



I



# SOHO collection



A



B



C



D

## A. SOHO ROUND GLASS BEVERAGE DISPENSERS

2 and 3 Gallon Capacity. Includes Drip Tray.  
Specify Color: Black (13), Silver (74).

### ICE CHAMBER

ITEM 1580-2 | 10Wx12Dx20½H

ITEM 1580-3 | 10Wx12Dx24½H

### INFUSION CHAMBER

ITEM 1580-2INF | 10Wx12Dx20½H

ITEM 1580-3INF | 10Wx12Dx24½H

## C. SOHO ICE HOUSING

Includes Clear Polycarbonate Ice Pan. Frost (33).

ITEM 1582-12-33 | 21Wx12Dx8¼H - Silver

## B. SOHO BREAD CASE

Specify Color: Black (13), Silver (74).

ITEM 1586 | 14Wx13Dx14¼H

### REPLACEMENT DRAWERS

ITEM 1586-13DRAWER | Drawer w/ Black Knob

ITEM 1586-74DRAWER | Drawer w/ Silver Knob

## D. SOHO CONDIMENT ORGANIZER

Holds up to 3.75" Diameter Cups & Lids.  
Includes Acrylic Insert for Stir Sticks & Packets.  
Specify Color: Black (13), Silver (74).

ITEM 1594 | 15¾Wx11¾Dx12H

Please visit [www.calmil.com/legal](http://www.calmil.com/legal) for a complete list of California Proposition 65 related items.

# SOHO

collection



**SIMPLISTIC AND MODERN**, this collection utilizes high quality metal with a ribbon-like flare for feet. Named for its similarity to popular cast-iron architecture found around the world, this refined line adds silent elegance to any presentation.



# SOHO collection



Attendant Serve

Now a reversible design for self or attendant serve! Featuring 3 different tray positions: tilted front, tilted back, and level.

Self Serve

A

## A. SOHO DISPLAY CASE

Includes 3 Acrylic Black Trays.

Self and Attendant Serve with 3 Tray Positions.  
Available Only in Black.

ITEM 1574-13 | 17¼Wx12¾Dx20¾H | 10x14 Trays

ITEM 1575-13 | 21¼Wx15¾Dx20¾H | 13x18 Trays

### REPLACEMENT TRAYS

Clear (12), Black (13).

ITEM 335-10-12 | Replacement 10x14 Tray

ITEM 335-10-13 | Replacement 10x14 Tray

ITEM 325-13-12 | Replacement 13x18 Tray

ITEM 325-13-13 | Replacement 13x18 Tray



B

## B. SOHO NAPKIN HOLDER

Holds 4" x 8" Napkins. Frost (33).

ITEM 1588-33 | 9½Wx6¼Dx3½H - Black

ITEM 1595-33 | 9½Wx6¼Dx3½H - Silver

C



## C. SOHO FLATWARE DISPLAY

Specify Color: Black (13), Silver (74).

ITEM 1544 | 4Wx4Dx4½H

Please visit [www.calmil.com/legal](http://www.calmil.com/legal) for a complete list of California Proposition 65 related items.



**D. SOHO 3 TIER CYLINDER DISPLAY**

Cylinders Sold Separately.  
Specify Color: Black (13), Silver (74).

ITEM 1583 | 8¾Wx8½Dx21H

**OPTIONAL CYLINDERS**

Available in Six Colors.

Stainless Steel Style: Perforated (39), (SOLID).  
Colored Melamine: Black (13), White (15),  
Butter Yellow (61), Terra Cotta (62), Sage (63),  
Cranberry (64). Extra Deep: White (8-15).

ITEM 1017-39 | 4½DIAx5½H

ITEM 1017-SOLID | 4½DIAx5½H

ITEM 1017 | 4½DIAx5½H

ITEM 1017-8-15 | 4½DIAx8H | Extra Deep



**E. SOHO BUTANE STOVE FRAME**

Iwatani Model 35FW Not Included.  
Specify Color: Black (13), Silver (74).

ITEM 1576 | 14Wx13¾Dx7¼H

ITEM 4010-I | Optional Butane Stove





# ONE BY ONE collection



A



B



C



D

**A. ONE BY ONE BLACK CHAFER**  
Includes Stainless Steel Chafer Cover.  
ITEM 3321-13 | 24¼Wx15¼Dx12H  
ITEM 3325-55 | Replacement Cover

**B. ONE BY ONE SILVER DISPLAY CASE**  
Self-Serve. Includes 3 – 13x18 Clear Trays.  
ITEM 1145-S-74 | 20½Wx17Dx22H  
ITEM 325-13-12 | Replacement 13x18 Tray

**C. ONE BY ONE CONDIMENT ORGANIZER**  
Insert is Removable for Cleaning.  
Specify Color: Black (13), Silver (74).  
ITEM 1148 | 13Wx14Dx6½H

**D. ONE BY ONE REVOLVING  
CUP & LID ORGANIZER**  
Holds Cups and Lids Up to 3.75" Diameter.  
Specify Color: Black (13), Silver (74).  
ITEM 1133 | 10Wx10Dx15¾H

Please visit [www.calmil.com/legal](http://www.calmil.com/legal) for a complete list of California Proposition 65 related items.

# ONE BY ONE

collection



**MADE UP OF SQUARE METAL FRAMES**, this collection presents the perfect balance of industrial and elegance. Offered in both black and silver, this modern line will enhance your display and complement your culinary creations.



# ONE BY ONE collection



A

## A. ONE BY ONE ACRYLIC BEVERAGE DISPENSER W/HANDLES

Available in 3 Gallon Capacity Only. Includes Drip Tray and Clear Insert to Secure Lid. Specify Color: Black (13), Silver (74).

### ICE CHAMBER

ITEM 3302-3 | 9Wx9Dx28½H

### INFUSION CHAMBER

ITEM 3302-3INF | 9Wx9Dx28½H



B

## B. ONE BY ONE ACRYLIC BEVERAGE DISPENSERS

1.5, 3, and 5 Gallon Capacities. Includes Drip Tray. Specify Color: Black (13), Silver (74).

### ICE CHAMBER

ITEM 1132-1 | 10¼Wx10½Dx17¾H

ITEM 1132-3 | 10¼Wx10½Dx25½H

ITEM 1132-5 | 11¾Wx12Dx29H

### INFUSION CHAMBER

ITEM 1132-1INF | 10¼Wx10½Dx17¾H

ITEM 1132-3INF | 10¼Wx10½Dx25½H

ITEM 1132-5INF | 11¾Wx12Dx29H



C

## C. WRITE-ON BEVERAGE SIGN

Fits all Square Beverage Dispensers!

ITEM 3059 | 5Wx3H - Stainless Steel

ITEM 3062-15 | White Chalkboard Pen

3059

Please visit [www.calmil.com/legal](http://www.calmil.com/legal) for a complete list of California Proposition 65 related items.



D

**D. ONE BY ONE CHAFER ALTERNATIVES**

- ITEM 1348-12-13 | 10¼Wx10Dx4H
- ITEM 1409-12-13 | 10¼Wx10Dx7H
- ITEM 1348-22-13 | 19¾Wx10Dx4H
- ITEM 1409-22-13 | 19¾Wx10Dx7H



E

**E. ONE BY ONE METAL CYLINDER DISPLAY**

Cylinders Sold Separately.  
Specify Color: Black (13), Silver (74).  
ITEM 1134 | 7½Wx6½Dx17½H



**OPTIONAL CYLINDERS**

Available in Six Colors.  
Stainless Steel Style: Perforated (39), (SOLID).  
Colored Melamine: Black (13), White (15),  
Butter Yellow (61), Terra Cotta (62), Sage (63),  
Cranberry (64). Extra Deep: White (8-15).

- ITEM 1017-39 | 4½DIAx5½H
- ITEM 1017-SOLID | 4½DIAx5½H
- ITEM 1017 | 4½DIAx5½H
- ITEM 1017-8-15 | 4½DIAx8H - Extra Deep

**F. ONE BY ONE 8½X11 METAL MAGNETIC SIGN DISPLAYS**

Features a Metal Sign with Magnetic Front  
for Secure Display. Holds 8½x11 Card Size.  
Specify Color: Black (13), Silver (74).

- ITEM 1153-46 | 8¾Wx8¾Dx46¼H
- ITEM 1153-15 | 8¾Wx8¾Dx15½H



F

Please visit [www.calmil.com/legal](http://www.calmil.com/legal) for a complete list of California Proposition 65 related items.



# ONE BY ONE collection



A

1146-13

1146-74



B

1155-13

**A. ONE BY ONE 4 DRAWER  
ACRYLIC BREAD CASE**  
Specify Color: Black (13), Silver (74).  
ITEM 1146 | 14Wx14¾Dx15¾H

**B. ONE BY ONE 3 TIER  
ACRYLIC BREAD CASE**  
Available in Black Only.  
ITEM 1155-13 | 9½Wx14¼Dx19¾H



C

**C. ONE BY ONE GLASS JAR DISPLAY**  
Includes 3 Glass Jars.  
Specify Color: Black (13), Silver (74).  
ITEM 1149 | 6¼Wx13¼Dx11½H  
ITEM C4X4GLCN | Replacement Jar

Please visit [www.calmil.com/legal](http://www.calmil.com/legal) for a complete list of California Proposition 65 related items.

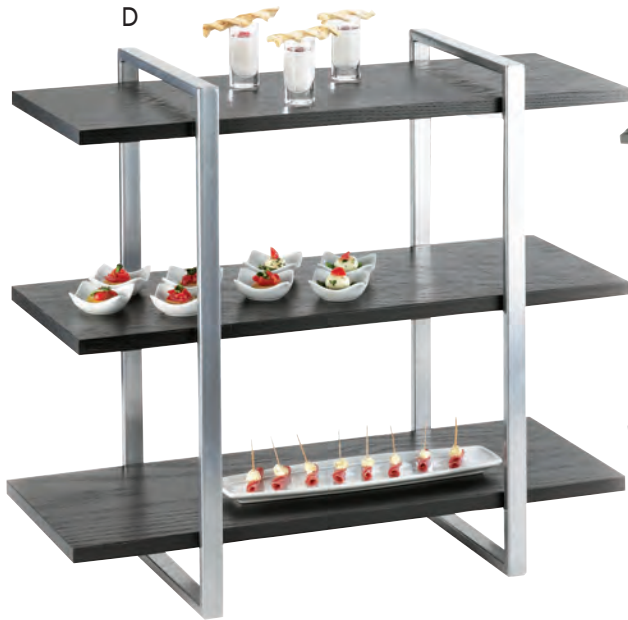

**D. ONE BY ONE**  
**3 SHELF METAL FRAME RISER**  
 Midnight Bamboo (96).  
 ITEM 1940-96 | 28Wx12Dx24H



**E. ONE BY ONE**  
**MULTI LEVEL SHELF DISPLAY**  
 Shelves Are Removable For Cleaning.  
 Specify Shelf Color: Bamboo (60),  
 Midnight Bamboo (96).  
 ITEM 3303 | 28½Wx13½Dx36½H - Black Stand  
 ITEM 3304 | 28½Wx13½Dx36½H - Silver Stand



**F. ONE BY ONE**  
**SILVER TIERED RISER**  
 Available in Silver Only.  
 Includes 3 White Corian Shelves.  
 ITEM 1140-74 | 32¼Wx13Dx10½H  
**REPLACEMENT WHITE CORIAN SHELVES**  
 ITEM 1128-1212-15 | 12Wx12Dx¼H

Please visit [www.calmil.com/legal](http://www.calmil.com/legal) for a complete list of California Proposition 65 related items.



# CLASSIC collection



A



B



C



D

## A. CLASSIC CUP & LID ORGANIZERS

Holds up to 3.75" Diameter Cups & Lids.

ITEM 2048-3 | 4½Wx16¼Dx16¼H

ITEM 2048-4 | 4½Wx19½Dx19¼H

ITEM 2051 | 4¾Wx20Dx20H

### OPTIONAL ACCESSORIES

ITEM 3573-13 | 3½Wx4H - Stir-Stick Holder

## C. CLASSIC ADJUSTABLE CONDIMENT ORGANIZER

Dividers are Adjustable for Maximum Efficiency.

ITEM 1260 | 12Wx12Dx5½H

## B. CLASSIC COFFEE CONDIMENT ORGANIZER

ITEM 1259 | 8Wx12Dx4H

## D. CLASSIC 3 TIER CONDIMENT DISPLAY

ITEM 2053 | 5¼Wx6¾Dx16H

ITEM 2054 | 10¼Wx6¾Dx16H

Please visit [www.calmil.com/legal](http://www.calmil.com/legal) for a complete list of California Proposition 65 related items.

# CLASSIC collection



**THE INDUSTRY STANDARD, REINVENTED.** This collection boasts highly durable and easy-to-clean black ABS plastic, which has been an industry staple for years. This consumer-friendly line is perfect for creating dynamic and refined tabletop presentations.



# CLASSIC collection



A



B



C



D



E



F

## A. BULK CONDIMENT STATION

Holds up to 3.75" Diameter  
Cups & Lids.

ITEM 3577 | 9¼Wx16¼Dx13H

## B. CLASSIC 4 TIER CONDIMENT DISPLAY

ITEM 1261 | 6½Wx12Dx20½H

## C. CLASSIC CONDIMENT ORGANIZER

Has 2 Slots for Standard Napkin  
Dispensers (Not Included).

ITEM 2044 | 16Wx19¼Dx16¾H

## D. REMOVABLE COMPARTMENT CONDIMENT ORGANIZER

ITEM 3569-6-13 | 13¼Wx7Dx23¼H

## E. CLASSIC CUP & LID ORGANIZER W/COFFEE SLEEVE DISPENSER

Coffee Sleeve Dispenser Sold Separately.  
Holds Up to 3.75" Diameter Cups or Lids.

ITEM 2045 | 9¼Wx19¼Dx16¾H

ITEM 2050 | Optional Sleeve Dispenser

## F. CLASSIC CUP/LID ORGANIZER

Has Slot for Standard Napkin Dispenser  
(Not Included). Dividers are Adjustable.  
Holds up to 4" Diameter Cups & Lids.

ITEM 2046 | 9¼Wx19¼Dx16½H

Please visit [www.calmil.com/legal](http://www.calmil.com/legal) for a complete list of California Proposition 65 related items.

G. 4 BIN CONDIMENT HOLDER  
ITEM 3643-4 | 8¾Wx21¼Dx12½H



H. 10 BIN CONDIMENT HOLDER  
ITEM 3643-10 | 21Wx12Dx12H



I. CLASSIC CONDIMENT ORGANIZER  
Holds Up to 3.75" Diameter Cups or Lids.  
ITEM 2047 | 14Wx22½Dx20¼H

J. CLASSIC CONDIMENT ORGANIZER  
Has Slot for Standard Napkin  
Dispenser (Not Included).  
Holds Up to 3.75" Diameter Cups or Lids.  
ITEM 2042 | 10Wx17¼Dx14¾H



K. STAINLESS STEEL COFFEE  
URN - FLAME HEATED  
ITEM 1009 | 12Wx12Dx26H

L. CLASSIC STIR-STICK  
& CONDIMENT DISPLAY  
Divider is Removable to Create  
More Capacity.  
ITEM 2052 | 5½Wx13¼Dx14½H

M. CLASSIC DOME  
LID & CUP ORGANIZER  
Holds up to 3.75" Diameter  
Cups & Lids.  
ITEM 724 | 15½Wx5Dx12H



Removable Divider



Please visit [www.calmil.com/legal](http://www.calmil.com/legal) for a complete list of California Proposition 65 related items.



# CLASSIC collection

A



**A. CLASSIC 2 LEVEL  
CONDIMENT ORGANIZER**  
ITEM 3690-13 | 13Wx9¼Dx11¼H

B



**B. CLASSIC CUP & LID  
ORGANIZER WITH STRAW /  
STIR STICK HOLDER**  
Holds Up to 3.75" Diameter  
Cups or Lids.  
ITEM 2041 | 14½Wx8¾Dx10¾H

C



**C. CLASSIC MENU /  
CONDIMENT HOLDER**  
ITEM 3729-13 | 7½Wx12Dx5H

**D. CLASSIC  
CONDIMENT STATION**  
Holds Up to 3.75" Diameter  
Cups or Lids.  
ITEM 3664-13 | 14Wx11Dx6½H

D



**E. CLASSIC SLANTED  
CONDIMENT ORGANIZER**  
ITEM 2059 | 6½Wx22¾Dx6¼H

E



**F. CLASSIC  
9 SECTION ORGANIZER**  
ITEM 3663-13 | 12½Wx12½Dx2H

F



Please visit [www.calmil.com/legal](http://www.calmil.com/legal) for a complete list of California Proposition 65 related items.

CREATE YOUR OWN TO-GO STATION!



22036-55-13



22040-55-13



22039-59-13



22033-713-13 With  
22035-713-13 Base



22032-1019-13 With  
22034-1019-13 Base



22038-59-13  
Holds Condiments  
and Will Fit 2ea  
22036-55-13 on Top



22037-515-13 Holds  
Condiments and Will Fit 3ea  
22036-55-13 on Top

**G. MODULAR TO-GO STATION NEW**

All Bases Include a Removable Divider.

ITEM 22036-55-13 | 4¾Wx4¾Dx6¼H | Cup Holder

ITEM 22040-55-13 | 4¾Wx4¾Dx6¼H | Utensil Holder

ITEM 22039-59-13 | 9½Wx4¾Dx6¼H | Napkin Holder

ITEM 22033-713-13 | 12¾Wx6¾Dx6¼H | Box Holder

ITEM 22035-713-13 | 12¾Wx6¾Dx3¼H | Box Holder Base

ITEM 22032-1019-13 | 9¾Wx18¾Dx6¼H | Box Holder

ITEM 22034-1019-13 | 9¾Wx18¾Dx3¼H | Box Holder Base

ITEM 22038-59-13 | 9½Wx4¾Dx3¼H | Fits 2 Cup Holders

ITEM 22037-515-13 | 14½Wx4¾Dx3¼H | Fits 3 Cup Holders

**H. CLASSIC VERTICAL DISPLAYS**

Cylinders Sold Separately.

Set Units Side by Side for More Capacity.

ITEM 1016-3 | 5½Wx8Dx20H

ITEM 1016-6 | 11Wx8Dx20H

**I. CLASSIC FLATWARE  
CONDIMENT ORGANIZER**

Cylinders Sold Separately.

Use for Flatware or Condiments!

ITEM 2049 | 11½Wx15¾Dx15¾H

**OPTIONAL CYLINDERS**

Available in Six Colors.

Stainless Steel Style: Perforated (39), (SOLID).

Colored Melamine: Black (13), White (15),

Butter Yellow (61), Terra Cotta (62), Sage (63),

Cranberry (64). Extra Deep: White (8-15).

ITEM 1017-39 | 4½DIAx5½H

ITEM 1017-SOLID | 4½DIAx5½H

ITEM 1017 | 4½DIAx5½H

ITEM 1017-8-15 | 4½DIAx8H | Extra Deep



1016-3

1016-6

8-15

61

62

63

64

15

13

SOLID

39

Please visit [www.calmil.com/legal](http://www.calmil.com/legal) for a complete list of California Proposition 65 related items.



# CLASSIC collection



**A. CLASSIC NAPKIN HOLDER**  
ITEM 3693-13 | 4Wx8H | Napkin Size

**B. CLASSIC PAPER TOWEL HOLDER**  
ITEM 952 | 4Wx8H | Paper Towel Size



**C. CLASSIC PACKET DISPLAY**  
ITEM 1246-13 | 9½Wx4½Dx2¼H

**D. 3 STEP BOTTLE RISER**  
Cutouts are 4½X4½.  
ITEM 3665-13 | 4½Wx14¼Dx6H



**E. MELAMINE HOUSING**  
Includes Clear Polycarbonate Bin.  
Specify Color: Black (13), White (15).  
ITEM 475-6 | 6Wx7Dx7H  
ITEM 475-10 | 10Wx12Dx7H  
ITEM 475-12 | 12Wx20Dx7H

**F. CLASSIC STIR STICK HOLDER**  
ITEM 3308-13 | 5Wx5Dx5¼H

**G. CLASSIC CONDIMENT ORGANIZER**  
Dividers are Adjustable.  
ITEM 2040 | 12Wx8½Dx4¼H

**H. CLASSIC NAPKIN HOLDER**  
5" Napkin Size.  
Specify Color: Clear (12), Black (13).  
ITEM 635 | 5Wx5H | Napkin Size



Please visit [www.calmil.com/legal](http://www.calmil.com/legal) for a complete list of California Proposition 65 related items.

**I. CLASSIC ACRYLIC BOTTLE ORGANIZER**

Cutouts are 3¼" DIA.

- ITEM P295 | 12¼Wx10Dx4½H | Clear
- ITEM P296 | 12Wx14¾Dx6¼H | Clear
- ITEM P297 | 12Wx19½Dx8¼H | Clear
- ITEM 677 | 9½Wx12¾Dx6½H | Black



**J. CLASSIC 3 TIER BOTTLE ORGANIZER**

Cutouts are 3¼" DIA.

- ITEM 2056 | 8½Wx14¾Dx6¼H
- ITEM 3666-13 | 4½Wx15Dx6½H

**K. CLASSIC PACKET ORGANIZER**

ITEM 399-13 | 4Wx3Dx3¼H

**L. EXPANDED CLASSIC PACKET ORGANIZER**

ITEM 3580-13 | 9½Wx2Dx2¾H

**M. CLASSIC BLACK AMENITY TRAY**

ITEM 353-13 | 15¼Wx12½Dx2H

**N. K-CUP & PACKET ORGANIZER**

ITEM 3579-13 | 5Wx6¾Dx5H

**O. CLASSIC K-CUP HOLDERS**

ITEM 3485-4-13 | 4½Wx2Dx5½H | 4 Slots

ITEM 3485-6-13 | 6¾Wx2Dx5½H | 6 Slots



Please visit [www.calmil.com/legal](http://www.calmil.com/legal) for a complete list of California Proposition 65 related items.



# CLASSIC collection



## A. CLASSIC NAPKIN, LID AND STRAW ORGANIZERS

Counter Top or Wall Mount.  
Hardware Not Included.  
Specify Color: Clear (12), Black (13).

ITEM 298 | 4½Wx4½Dx8H

ITEM 299 | 5¼Wx5¼Dx8H

ITEM 787 | 4¼Wx4¼Dx6H

## B. CLASSIC CUP/LID ORGANIZER

Counter Top or Wall Mount.  
Hardware Not Included. Holds 5x5  
Napkins and Up to 4" DIA Lids.

ITEM 1013 | 13½Wx7¼Dx11½H

## C. CLASSIC NAPKIN/LID ORGANIZER

Specify Color: Clear (12), Black (13).  
Holds 5x5 Napkins and Up to 4" DIA Lids.

ITEM 375 | 13¼Wx5¼Dx8H

## D. CLASSIC NAPKIN/LID ORGANIZERS

Specify Color: Clear (12), Black (13).  
Holds 5x5 Napkins and Up to 4" DIA Lids.

ITEM 376 | 17½Wx5Dx8H

## E. CLASSIC ROOM SERVICE TRAYS

ITEM 930-1-13 | 22½Wx17Dx1H

ITEM 930-2-13 | 16Wx13Dx1H

ITEM 930-3-13 | 26Wx18Dx1H

ITEM 958-1-13 | 22½Wx18Dx1¾H

ITEM 958-2-13 | 16Wx13Dx1½H

Please visit [www.calmil.com/legal](http://www.calmil.com/legal) for a complete list of California Proposition 65 related items.



**F. CLASSIC SALSA/CONDIMENT BAR**

Complete Set w/Pans as Shown.

ITEM 658 | 14Wx15Dx20H

ITEM 1102 | 20½Wx12¾Dx19¾H



**G. CLASSIC CHILLED SALSA DRESSING SERVER**

Fill Bottom of Bin with Ice and Serve!  
Includes 4 White Crocks.

ITEM 3369-13 | 10½Wx10½Dx7H



**H. 4 SECTION CONDIMENT STATION**

Includes 4-1/6 Pans and Notched Lids.

ITEM 3687-13 | 13¾Wx16¼Dx9H



**I. ACRYLIC PEBBLE BELL BOWLS**

ITEM 403-10-34 | 10¼DIAx4¾H

ITEM 403-15-34 | 15DIAx7H



**J. ACRYLIC PEBBLE SALAD BOWLS**

ITEM 401-12-34 | 12¼DIAx4H

ITEM 401-15-34 | 15DIAx5H

ITEM 401-18-34 | 17¾DIAx5½H

ITEM 401-24-34 | 23½DIAx7¼H



# beverage dispensers

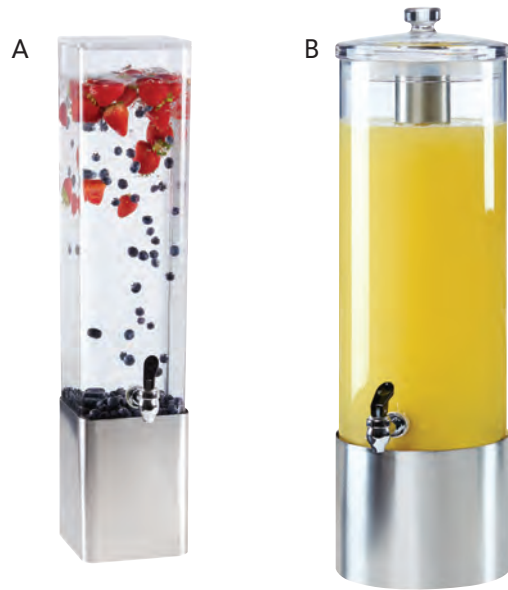
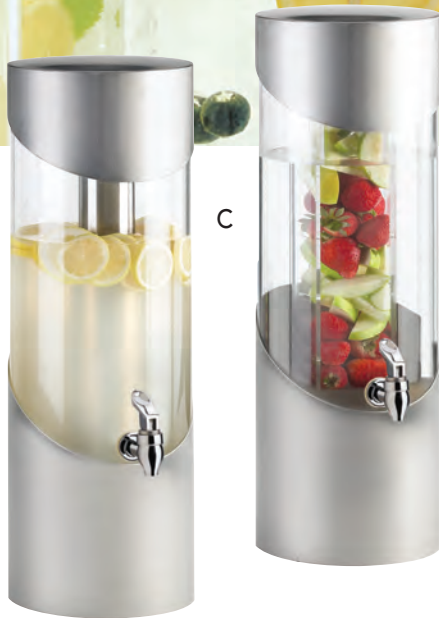

**A. STAINLESS STEEL  
2 GALLON DISPENSER **NEW****

Does Not Include Ice or Infusion Chamber.

ITEM 22075-2-55 | 6Wx8¼Dx26¾H

**B. STAINLESS STEEL  
BEVERAGE DISPENSER **NEW****

**ICE CHAMBER**

ITEM 22095-3-55 | 8Wx11Dx26½H | 3 Gallon

ITEM 22095-5-55 | 10Wx12½Dx32H | 5 Gallon

**INFUSION CHAMBER**

ITEM 22095-3INF-55 | 8Wx11Dx26½H | 3 Gallon

ITEM 22095-5INF-55 | 10Wx12½Dx32H | 5 Gallon

**C. ROUND STAINLESS STEEL  
BEVERAGE DISPENSER**

3 Gallon Capacity.  
Includes Drip Tray and Chamber.

ITEM 1990-3-55 | 8¼Wx10½Dx23½H | Ice Chamber

ITEM 1990-3INF-55 | 8¼Wx10½Dx23½H | Infusion Chamber



**D. SQUARE STAINLESS STEEL  
BEVERAGE DISPENSER**

3 Gallon Capacity.  
Includes Drip Tray and Chamber.

ITEM 1991-3-55 | 7¼Wx9½Dx24½H | Ice Chamber

ITEM 1991-3INF-55 | 7¼Wx9½Dx24½H | Infusion Chamber

**E. STAINLESS STEEL  
BEVERAGE DISPENSER**

3 Gallon Capacity. Polycarbonate Tank.  
Includes Drip Tray and Chamber.

ITEM 3324-3-55 | 7½Wx9½Dx23½H | Ice Chamber

ITEM 3324-3INF-55 | 7½Wx9½Dx23½H | Infusion Chamber

Please visit [www.calmil.com/legal](http://www.calmil.com/legal) for a complete list of California Proposition 65 related items.



F



G



**F. PORTLAND  
BEVERAGE DISPENSER**

3 Gallon Capacity.  
Includes Chamber and Drip Tray.

Specify Color: Black (13), White (15) **NEW**.

ITEM 4102-3 | 8Wx8Dx25H | Ice Chamber

ITEM 4102-3INF | 8Wx8Dx25H | Infusion Chamber

**G. EMPIRE  
BEVERAGE DISPENSER **NEW****

3 Gallon Capacity.  
Includes Chamber and Drip Tray.

ITEM 22090-3-90 | 8½Wx10Dx24¾H | Ice Chamber

ITEM 22090-3INF-90 | 8½Wx10Dx24¾H | Infusion Chamber

H



I



**H. ASHWOOD  
BEVERAGE DISPENSER**

3 Gallon Capacity.  
Includes Chamber and Drip Tray.

ITEM 3804-3-83 | 8Wx8Dx26H | Ice Chamber

ITEM 3804-3INF-83 | 8Wx8Dx26H | Infusion Chamber

**I. MONTEREY  
BEVERAGE DISPENSER **NEW****

3 Gallon Capacity.  
Includes Chamber and Drip Tray.

ITEM 22117-3-15 | 8½Wx10Dx25½H | Ice Chamber

ITEM 22117-3INF-15 | 8½Wx10Dx25½H | Infusion Chamber

J



**J. CINDERWOOD  
BEVERAGE DISPENSER**

3 Gallon Capacity.  
Includes Chamber and Drip Tray.

ITEM 3804-3-87 | 8Wx8Dx26H | Ice Chamber

ITEM 3804-3INF-87 | 8Wx8Dx26H | Infusion Chamber

Please visit [www.calmil.com/legal](http://www.calmil.com/legal) for a complete list of California Proposition 65 related items.



# beverage dispensers



A



B



C

## A. MADERA ROUND BEVERAGE DISPENSER **NEW**

3 Gallon Capacity.  
Includes Chamber and Drip Tray.

ITEM 4306-3-99 | 10½Dx24H  
Ice Chamber

ITEM 4306-3INF-99 | 10½Dx24H  
Infusion Chamber

## B. MADERA BEVERAGE DISPENSER

3 Gallon Capacity.  
Includes Chamber and Drip Tray.

ITEM 1527-3-99 | 8½Wx8½Dx26¾H  
Ice Chamber

ITEM 1527-3INF-99 | 8½Wx8½Dx26¾H  
Infusion Chamber



D



E

## C. INDUSTRIAL MADERA BEVERAGE DISPENSER

3 Gallon Capacity.  
Includes Chamber and Drip Tray.

ITEM 3561-3-99 | 8Wx8Dx25½H  
Ice Chamber

ITEM 3561-3INF-99 | 8Wx8Dx25½H  
Infusion Chamber

## D. BAMBOO/MIDNIGHT BAMBOO CRATE BEVERAGE DISPENSER

3 Gallon Capacity.  
Includes Chamber and Drip Tray.  
Specify Color: Bamboo (60),  
Midnight Bamboo (96).

ITEM 3301-3 | 8Wx8Dx25½H  
Ice Chamber

ITEM 3301-3INF | 8Wx8Dx25½H  
Infusion Chamber



F



Fill the Decorative  
Infusion Wall with  
Sliced Fruit for an  
Innovative Display!



## E. SIERRA BEVERAGE DISPENSER

3 Gallon Capacity.  
Includes Chamber and Drip Tray.

ITEM 3906-3-84 | 8¾Wx8¾Dx24H

ITEM 3906-3INF-84 | 8¾Wx8¾Dx24H

## F. BAMBOO DISPENSERS WITH DECORATIVE INFUSION WALL

3 Gallon Capacity. Includes Drip Tray.  
Specify Color: Bamboo (60), Midnight  
Bamboo (96).

ITEM 3697-3 | 8¼Wx9¾Dx25¾H

Please visit [www.calmil.com/legal](http://www.calmil.com/legal) for a complete list of California Proposition 65 related items.

**G. GRANADA  
BEVERAGE DISPENSER**

3 Gallon Capacity.  
Includes Chamber and Drip Tray.

ITEM 4027-3-85 | 8¼Wx8¼Dx25½H | Ice Chamber

ITEM 4027-3INF-85 | 8¼Wx8¼Dx25½H | Infusion Chamber



Your Custom Insert

**H. MID-CENTURY  
BEVERAGE DISPENSER**

3 Gallon Capacity.  
Includes Drip Tray and Chamber.  
Specify Color: Brass (46), Chrome (49).

ITEM 3703-3 | 8¼Wx10Dx24H | Ice Chamber

ITEM 3703-3INF | 8¼Wx10Dx24H | Infusion Chamber

**I. MIDNIGHT BAMBOO  
BEVERAGE DISPENSER**

1.5 and 3 Gallon Capacities.  
Includes Drip Tray and Chamber.

**ICE CHAMBER**

ITEM 1527-1-96 | 8¼Wx9¼Dx17¾H

ITEM 1527-3-96 | 8¼Wx9¼Dx25¾H

**INFUSION CHAMBER**

ITEM 1527-1INF-96 | 8¼Wx9¼Dx17¾H

ITEM 1527-3INF-96 | 8¼Wx9¼Dx25¾H



**J. WESTPORT WOOD  
BEVERAGE DISPENSER**

1.5 and 3 Gallon Capacities.  
Includes Drip Tray and Chamber.

**ICE CHAMBER**

ITEM 1527-1-52 | 8¼Wx9¼Dx17¾H

ITEM 1527-3-52 | 8¼Wx9¼Dx25¾H

**INFUSION CHAMBER**

ITEM 1527-1INF-52 | 8¼Wx9¼Dx17¾H

ITEM 1527-3INF-52 | 8¼Wx9¼Dx25¾H



**K. BAMBOO  
BEVERAGE DISPENSER**

1.5 and 3 Gallon Capacities.  
Includes Drip Tray and Chamber.

**ICE CHAMBER**

ITEM 1527-1-60 | 8¼Wx9¼Dx17¾H

ITEM 1527-3-60 | 8¼Wx9¼Dx25¾H

**INFUSION CHAMBER**

ITEM 1527-1INF-60 | 8¼Wx9¼Dx17¾H

ITEM 1527-3INF-60 | 8¼Wx9¼Dx25¾H

Please visit [www.calmil.com/legal](http://www.calmil.com/legal) for a complete list of California Proposition 65 related items.



# beverage dispensers



## A. SQUARED BEVERAGE DISPENSER

1.5 and 3 Gallon Capacities.

Includes Drip Tray.

Specify Color: Black (13), Stainless Steel (55).

ITEM 1602-1 | 7½Wx9½Dx17¾H | Ice Chamber

ITEM 1602-3 | 7½Wx9½Dx25¾H | Ice Chamber

ITEM 1602-1INF | 7½Wx9½Dx17¾H | Infusion Chamber

ITEM 1602-3INF | 7½Wx9½Dx25¾H | Infusion Chamber

## B. LUXE BEVERAGE DISPENSER

3 Gallon Capacity.

Includes Chamber and Drip Tray.

Stainless Steel (55).

ITEM 3002-3-55 | 7¾Wx7¾Dx25¾H | Ice Chamber

ITEM 3002-3INF-55 | 7¾Wx7¾Dx25¾H | Infusion Chamber

## C. STAINLESS STEEL GLASS BEVERAGE DISPENSER

2 Gallon Capacity.

Includes Chamber and Drip Tray.

ITEM 1111-55 | 10¾Wx11½Dx22¾H | Ice Chamber

ITEM 1111INF-55 | 10¾Wx11½Dx22¾H | Infusion Chamber



## D. ROUND STAINLESS BEVERAGE DISPENSER

Stainless Steel (55).

ITEM 3565-3-55 | 12Wx12Dx26H | Ice Chamber

ITEM 3565-3INF-55 | 12Wx12Dx26H | Infusion Chamber

## E. UNION SQUARE BEVERAGE DISPENSER

3 Gallon Capacity.

Includes Chamber and Drip Tray.

ITEM 3370-3-13 | 8½Wx9Dx23½H | Ice Chamber

ITEM 3370-3INF-13 | 8½Wx9Dx23½H | Infusion Chamber



## F. CLASSIC SQUARE BEVERAGE DISPENSER

1.5 and 3 Gallon Capacity.

Powder Coated Metal Base.

Includes Drip Tray and Chamber.

ITEM 1112-1-13 | 7Wx9Dx19H | Glass

ITEM 1112-1A-13 | 7Wx9Dx19H | Acrylic

ITEM 1112-3-13 | 7Wx9Dx26½H | Glass

ITEM 1112-3A-13 | 7Wx9Dx26½H | Acrylic

Please visit [www.calmil.com/legal](http://www.calmil.com/legal) for a complete list of California Proposition 65 related items.

**G. SQUARE WIRE DISPENSER**

3 Gallon Capacity.  
Includes Chamber and Drip Tray.  
Specify Color: Brass (46), Chrome (49).

ITEM 22002-3 | 8¼Wx9¼Dx25¾H | Ice Chamber

ITEM 22002-3INF | 8¼Wx9¼Dx25¾H | Infusion Chamber



**H. ROUND WIRE DISPENSER**

3 & 5 Gallon Capacity.  
Includes Chamber and Drip Tray.  
Specify Color: Brass (46), Chrome (49).

**ICE CHAMBER**

ITEM 22005-3 | 8¼Wx9¼Dx25¾H | 3 Gallon

ITEM 22005-5 | 10Wx12½Dx32H | 5 Gallon

**INFUSION CHAMBER**

ITEM 22005-3INF | 8¼Wx9¼Dx25¾H | 3 Gallon

ITEM 22005-5INF | 10Wx12½Dx32H | 5 Gallon

**I. MADERA PORCELAIN BEVERAGE DISPENSER**

Base and Dispenser Sold Separately.  
1.5 Gallon Capacity.  
Chalkboard Urn Sign Included with Dispenser.

ITEM 3460-1BEV | 10Wx10Dx11H | Dispenser

ITEM 432-6-99 | 12Wx12Dx6H | Wood Base



**J. PORCELAIN BEVERAGE DISPENSER**

Includes Drip Tray and Chalkboard Sign w/ Chain. 1.5 Gallon Capacity.

ITEM 3460-1BEV | 10Wx10Dx11H | Dispenser Only

ITEM 3460-1-13 | 10Wx10Dx18H | Dispenser & Base

ITEM 3062-15 | White Chalkboard Pen

**K. MADERA GLASS BEVERAGE DISPENSER**

2 Gallon Capacity. Includes Glass Dispenser, Base, Chamber, and Drip Tray.

ITEM 3422-2 | 10¼Wx11½Dx22¾H | Ice Chamber

ITEM 3422-2INF | 10¼Wx11½Dx22¾H | Infusion Chamber



**L. GLASS BEVERAGE DISPENSER WITH WALNUT BASE**

2 Gallon Capacity.  
Includes Glass Dispenser, Base, and Ice Chamber.

ITEM 3568-2-78 | 10¼Wx10¼Dx21H

Please visit [www.calmil.com/legal](http://www.calmil.com/legal) for a complete list of California Proposition 65 related items.



# beverage dispensers



## A. ONE BY ONE BEVERAGE DISPENSER WITH HANDLES

3 Gallon Capacity Only.

Includes Drip Tray and Clear Insert to Secure Lids.

Specify Color: Black (13), Silver (74).

ITEM 3302-3 | 9Wx9Dx28½H | Ice Chamber

ITEM 3302-3INF | 9Wx9Dx28½H | Infusion Chamber



## B. ONE BY ONE BEVERAGE DISPENSER

Includes Drip Tray and Chamber.

Specify Color: Black (13), Silver (74).

### ICE CHAMBER

ITEM 1132-1 | 10¼Wx10½Dx17¾H - 1.5 Gallon

ITEM 1132-3 | 10¼Wx10½Dx25½H - 3 Gallon

ITEM 1132-5 | 11¾Wx12Dx29H - 5 Gallon

### INFUSION CHAMBER

ITEM 1132-1INF | 10¼Wx10½Dx17¾H | 1.5 Gallon

ITEM 1132-3INF | 10¼Wx10½Dx25½H | 3 Gallon

ITEM 1132-5INF | 11¾Wx12Dx29H | 5 Gallon

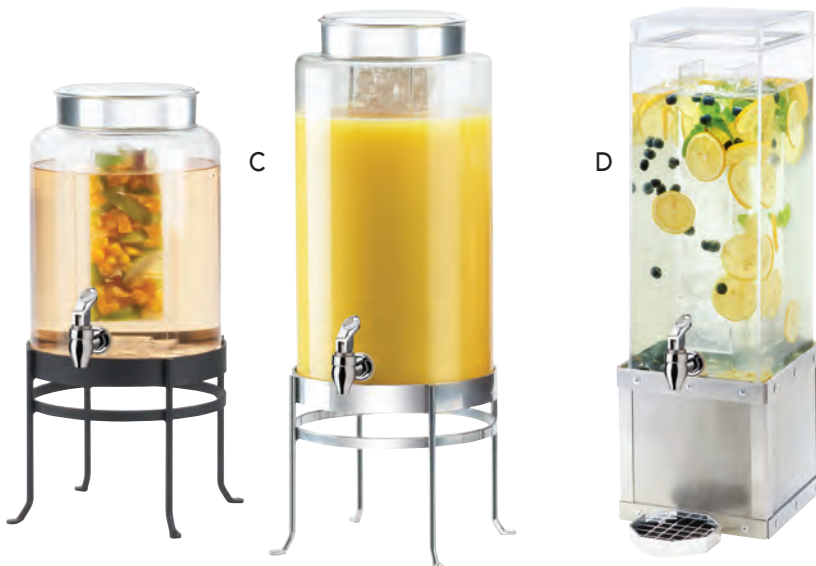

## C. SOHO ROUND GLASS BEVERAGE DISPENSER

2 and 3 Gallon Capacities.

Includes Drip Tray.

Specify Color: Black (13) or Silver (74).

ITEM 1580-2 | 10Wx12Dx20½H | Ice Chamber

ITEM 1580-3 | 10Wx12Dx24½H | Ice Chamber

ITEM 1580-2INF | 10Wx12Dx20½H | Infusion Chamber

ITEM 1580-3INF | 10Wx12Dx24½H | Infusion Chamber

## D. URBAN BEVERAGE DISPENSER

3 Gallon Capacity.

Includes Chamber and Drip Tray.

Stainless Steel (55).

ITEM 3394-3-55 | 8Wx8Dx24H | Ice Chamber

ITEM 3394-3INF-55 | 8Wx8Dx24H | Infusion Chamber

Please visit [www.calmil.com/legal](http://www.calmil.com/legal) for a complete list of California Proposition 65 related items.

**E. STAINLESS POLYCARBONATE BEVERAGE DISPENSER**

3 Gallon Capacity.  
Includes Chamber.

ITEM 1282-3A | 14Wx10½Dx26½H | Ice Chamber

ITEM 1282-3AINF | 14Wx10½Dx26½H | Infusion Chamber



**F. CLASSIC OCTAGON BEVERAGE DISPENSER**

Includes Drip Tray and Ice Chamber.

ITEM 972-1-17 | 11Wx11Dx18H | 1.5 Gallon

ITEM 972-2-17 | 10Wx10Dx20H | 2 Gallon

ITEM 972-3-17 | 11Wx11Dx22H | 3 Gallon

ITEM 972-5-17 | 13Wx13Dx22H | 5 Gallon

**G. GLACIER ACRYLIC BEVERAGE DISPENSER**

2 and 3 Gallon Capacities.  
Includes Drip Tray and Chamber.

ITEM 932-2 | 10Wx10Dx20H | Ice Chamber

ITEM 932-3 | 11Wx11Dx22H | Ice Chamber

ITEM 932-2INF | 10Wx10Dx20H | Infusion Chamber

ITEM 932-3INF | 11Wx11Dx22H | Infusion Chamber



**H. IRON BEVERAGE DISPENSER**

2 Gallon Capacity.  
Includes Drip Tray and Chamber.

**ICE CHAMBER**

ITEM 1111 | 10¾Wx11½Dx22¾H | Glass

**INFUSION CHAMBER**

ITEM 1111INF | 10¾Wx11½Dx22¾H | Glass

**I. WRITE-ON BEVERAGE SIGNS**

Fits all Square Beverage Dispensers!

ITEM 3059 | 5Wx3H Stainless Steel

ITEM 3616-99 | 5Wx4H Madera

ITEM 3062-15 | White Chalkboard Pen



3616-99

3059

**J. CLASSIC GLASS-STACKING TRAY**

Sold Individually.  
Not Sold as a Set.

ITEM 353-13 | 15¼Wx12½Dx2H





# beverage dispensers



**A. OCTAGON  
STAINLESS STEEL BASE  
BEVERAGE DISPENSER**  
3 Gallon Capacity.  
Includes Drip Tray and Ice Chamber.  
ITEM 152-SS | 11Wx11Dx23½H

**B. STAINLESS STEEL BASE  
BEVERAGE DISPENSER**  
2 Gallon Capacity.  
ITEM 1010 | 10Wx14Dx23H | Ice Chamber  
ITEM 1010INF | 10Wx14Dx23H | Infusion Chamber



**C. TALL STAINLESS STEEL  
BASE BEVERAGE DISPENSER**  
1.5 Gallon Capacity.  
Includes Ice Chamber.  
ITEM 1494 | 7Wx12Dx30H

**D. STAINLESS STEEL  
BEVERAGE DISPENSER**  
ITEM 3497-3BEV | 14Wx14Dx11H | Dispenser Only  
ITEM 3497-3-55 | 14Wx14Dx18H | Dispenser & Base

Please visit [www.calmil.com/legal](http://www.calmil.com/legal) for a complete list of California Proposition 65 related items.

**E. METAL BAND  
BEVERAGE DISPENSER**

Metal Band with Polycarbonate Tank and Base. Includes Drip Tray.  
3 Gallon Capacity.  
Specify Color: Black (13) or Silver (74).

ITEM 2016 | 8Wx10Dx24H | Ice Chamber  
ITEM 2016INF | 8Wx10Dx24H | Infusion Chamber



**F. ROUND STAINLESS STEEL  
BEVERAGE DISPENSER**

3 Gallon Capacity.  
Includes Ice Chamber.

ITEM 22003-3-55 | 8¼Wx9¾Dx25¾H



**G. CLASSIC ROUNDED  
BEVERAGE DISPENSER**

3 Gallon Capacity.  
Includes Drip Tray and Ice Chamber.

ITEM 1610 | 11Wx11Dx19H

**H. SQUARE CLEAR  
BEVERAGE DISPENSER**

1.5, 3, and 5 Gallon Capacities Available.  
Includes Drip Tray and Chamber.

**ICE CHAMBER**

ITEM 1112-1 | 7¼Wx9¼Dx18½H | Glass  
ITEM 1112-1A | 7¼Wx9¼Dx18½H | Acrylic  
ITEM 1112-3 | 7Wx9¼Dx26H | Glass  
ITEM 1112-3A | 7½Wx7½Dx26½H | Acrylic  
ITEM 1112-5A | 9Wx11½Dx29¼H | Acrylic

**INFUSION CHAMBER**

ITEM 1112-1INF | 7¼Wx9¼Dx18½H | Glass  
ITEM 1112-1AINF | 7¼Wx9¼Dx18½H | Acrylic  
ITEM 1112-3INF | 7Wx9¼Dx26H | Glass  
ITEM 1112-3AINF | 7Wx9Dx26½H | Acrylic  
ITEM 1112-5AINF | 9Wx11½Dx29¼H | Acrylic



**I. SQUARE ACYRLIC BEVERAGE  
DISPENSER WITH HANDLES**

3 and 5 Gallon Capacities.  
Includes Drip Tray and Chamber.

**ICE CHAMBER**

ITEM 1112-3AH | 7½Wx7½Dx26½H | 3 Gallon  
ITEM 1112-5AH | 9Wx11½Dx29¼H | 5 Gallon

**INFUSION CHAMBER**

ITEM 1112-3AINFH | 7½Wx7½Dx26½H | 3 Gallon  
ITEM 1112-5AINFH | 9Wx11½Dx29¼H | 5 Gallon



# pitchers & drip trays



**A. GLASS PITCHERS & CADDY**  
Caddy Includes 6 – 32 Ounce Glass Pitchers.  
ITEM 3660-13 | 11Wx7½Dx14H Caddy  
ITEM 3674-34 | Replacement Glass Pitcher



**B. CLASSIC BLACK DRIP TRAYS**  
ITEM 308-4-13 | 4Wx4Dx1H | Octagon  
ITEM 308-6-13 | 6Wx6Dx1H | Octagon  
ITEM 681-4-13 | 4Wx4Dx1H | Square  
ITEM 681-6-13 | 6Wx6Dx1H | Square



**C. DRIP TRAYS**  
Drip Trays are Removable for Cleaning.  
Specify Color: Westport (52), Bamboo (60),  
or Madera (99).  
ITEM 330-4 | 4Wx4Dx1½H | Not Available in Westport  
ITEM 330-6 | 6Wx6Dx1½H

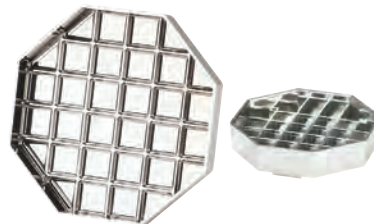

**D. CHROME DRIP TRAYS**  
ITEM 308-4-49 | 4Wx4Dx1H  
ITEM 308-6-49 | 6Wx6Dx1H



**E. SILVER TRIM DRIP TRAYS**  
ITEM 391-010 | 6Wx6Dx1H  
ITEM 392-010 | 4Wx4Dx1H



**F. STONE DRIP TRAYS**  
Drip Trays are Removable for Cleaning.  
ITEM 310-4-31 | 4Wx4Dx1H | Octagon  
ITEM 310-6-31 | 6Wx6Dx1H | Octagon  
ITEM 330-4-31 | 4Wx4Dx1H | Square  
ITEM 330-6-31 | 6Wx6Dx1H | Square



**G. ENGRAVED DRIP TRAYS**  
ITEM 632-1 | 4Wx4Dx1H | Coffee  
ITEM 632-2 | 4Wx4Dx1H | Decaf  
ITEM 632-3 | 4Wx4Dx1H | Hot Water



**H. DRIP MINDER™**  
Drip Trays are Removable.  
ITEM DM005 | 16¾Wx13Dx6½H

Please visit [www.calmil.com/legal](http://www.calmil.com/legal) for a complete list of California Proposition 65 related items.



**I. POLYCARBONATE PITCHERS**

2 Liter Capacity.

ITEM 682 | 9DIAx10H | Without Chamber

ITEM 682-ICE | 9DIAx10H

ITEM 682-INFUSION | 9DIAx10H

**J. ACRYLIC PITCHER WITH ICE AND INFUSION CHAMBER**

¾ Gallon Capacity.

ITEM JC102 | 8Wx8Dx10H

**K. GLASS PITCHER WITH ICE CHAMBER**

½ Gallon Capacity.

ITEM JC100 | 4Wx8Dx8H

**L. POLYCARBONATE PITCHER **NEW****

2 Liter Capacity.

ITEM 22054 | 9DIAx10¼H

**M. 1 LITER WHITE/STAINLESS CARAFE**

Polycarbonate Pitcher with Stainless Pour Spout.

ITEM 3614-55 | 4DIAx10H

ITEM 3614-55CL | 4DIAx10H

**N. 1.5 LITER WHITE/STAINLESS CARAFE**

Polycarbonate Pitcher with Stainless Pour Spout.

ITEM 3551-55 | 4DIAx13H

ITEM 3551-55CL | 4DIAx13H

**O. POLYCARBONATE CARAFE**

1 Liter Capacity.

ITEM 438 | 4DIAx10H



3614-55CL and 3551-55CL feature an alternative hinged lid design!

Please visit [www.calmil.com/legal](http://www.calmil.com/legal) for a complete list of California Proposition 65 related items.



# beverage & serving carts



## A. MID-CENTURY BEVERAGE CARTS

Cart Only. Accessories Sold Separately.  
Features Walnut Shelves and Clear Removable Liner.  
Cart Ships by Truck Only.  
Specify Color: Brass (46), Chrome (49).

ITEM 3719 | 27Wx16Dx36H | Cart

## B. MADERA BEVERAGE CART

Accessories Sold Separately.  
Cart Ships by Truck Only.

ITEM 3461-99 | 27Wx16Dx41H | Cart

## OPTIONAL BEVERAGE DISPENSERS

ITEM 3553ICE | Green Glass 2 Gal. Dispenser | Ice

ITEM 3554ICE | Clear 3 Gal. Dispenser | Ice

ITEM 3554INF | Clear 3 Gal. Dispenser | Infusion

ITEM 3460-1BEV | White Porcelain | 1.5 Gal. Dispenser

Please visit [www.calmil.com/legal](http://www.calmil.com/legal) for a complete list of California Proposition 65 related items.



**C. SIERRA BEVERAGE CART**

Accessories Sold Separately.  
Cart Ships by Truck Only.

ITEM 3913-84 | 36Wx17½Dx39H

**BEVERAGE DISPENSER SHOWN**

ITEM 3460-1BEV | White Porcelain | 1.5 Gal. Dispenser



**D. IRON BEVERAGE CART**

Cart Only.  
Beverage Dispenser and Accessories  
Sold Separately.  
Includes Clear Removable Liners.  
Cart Ships by Truck Only.

ITEM 3583-13 | 29Wx18½Dx41¾H



**E. ASHWOOD BEVERAGE CART**

Cart Only.  
Beverage Dispenser and Accessories  
Sold Separately.  
Cart Ships by Truck Only.

ITEM 3834-83 | 31Wx20¼Dx39¼H

**OPTIONAL ACCESSORIES**

ITEM 1111 | Beverage Dispenser

ITEM 3836-3-83 | Jar Holder

ITEM 3800-10-83 | Ice Housing

Please visit [www.calmil.com/legal](http://www.calmil.com/legal) for a complete list of California Proposition 65 related items.

**CAL•MIL** | visit us online at: [www.calmil.com](http://www.calmil.com) | call toll-free 800-321-9069



# beverage & serving carts



## A. PORTLAND MERCHANTISER CART

Includes Clear Insert Trays.

Specify Color: Black (13), White (15) **NEW**.

ITEM 4111 | 15Wx14Dx35H

## B. MADERA SERVING CART **NEW**

Accessories Sold Separately.

Ships by Truck Only.

ITEM 22123-99 | 48Wx18Dx70½H

Please visit [www.calmil.com/legal](http://www.calmil.com/legal) for a complete list of California Proposition 65 related items.



**C. SIERRA MODULAR CART NEW**  
 U-Build Cart Includes 3 Wood Shelves, Locking  
 Wheels, and Brackets.  
 Accessories Sold Separately.  
 ITEM 22101-99 | 72Wx24Dx44H



**D. ACCESSORY ACTION  
 STATION SHELF NEW**  
 Shelf Includes Removable Inserts  
 for 2 Induction Units and Cold Well.  
 ITEM 22102-99 | 72Wx24Dx1½H

**OPTIONAL ACCESSORIES**

- ITEM 3633-COOKTOP | Optional Induction Stove
- ITEM 22109-55 | Cold Well With Condensation Liner

**MELAMINE INSERTS FOR COLD WELL**

- ITEM 22120-15 | 6¼Wx6¼Dx3¾H | 1/6 Pan
- ITEM 22121-15 | 12½Wx6¼Dx3¾H | 1/3 Pan
- ITEM 22122-15 | 12½Wx10¼Dx3¾H | 1/2 Pan



**E. ACCESSORY ACTION  
 STATION PANELS NEW**  
 Panels Attached by Magnets.  
 Attendant Side Remains Uncovered.  
 ITEM 22103 | 6 Separate Panels

Please visit [www.calmil.com/legal](http://www.calmil.com/legal) for a complete list of California Proposition 65 related items.



# beverage & serving carts



3698-6-87 Shown with  
Optional Accessory Top  
Shelf 3698-6-87SHELF.



## A. U-BUILD CINDERWOOD CARTS

Cart Includes 3 Large Shelves,  
Support Beams, and Wheels.  
Small Accessory Top Shelf  
Sold Separately.  
Ships by Truck Only.

ITEM 3698-4-87 | 48Wx24Dx44H

ITEM 3698-6-87 | 72Wx24Dx44H

### OPTIONAL ACCESSORIES

ITEM 3698-4-87SHELF | 48" Accessory Top Shelf

ITEM 3698-6-87SHELF | 72" Accessory Top Shelf

Please visit [www.calmil.com/legal](http://www.calmil.com/legal) for a complete list of California Proposition 65 related items.

**B. U-BUILD ASHWOOD CARTS**

Cart Includes 3 Large Shelves,  
Support Beams, and Wheels.  
Small Accessory Top Shelf  
Sold Separately.  
Ships by Truck Only.

ITEM 3698-4-83 | 48Wx24Dx44H

ITEM 3698-6-83 | 72Wx24Dx44H

**OPTIONAL ACCESSORIES**

ITEM 3698-4-83SHELF | 48" Accessory Top Shelf

ITEM 3698-6-83SHELF | 72" Accessory Top Shelf



3698-6-83 Shown with  
Optional Accessory Top  
Shelf 3698-6-83SHELF.



**C. U-BUILD SIERRA CARTS**

Cart Includes 3 Large Shelves,  
Support Beams, and Wheels.  
Small Accessory Top Shelf  
Sold Separately.  
Ships by Truck Only.

ITEM 3698-4-84 | 48Wx24Dx44H | Cart

ITEM 3698-6-84 | 72Wx24Dx44H | Cart

**OPTIONAL ACCESSORIES**

ITEM 3698-4-84SHELF | 48" Accessory Top Shelf

ITEM 3698-6-84SHELF | 72" Accessory Top Shelf

ITEM 3698-BRACKET | Bronze Bracket



Please visit [www.calmil.com/legal](http://www.calmil.com/legal) for a complete list of California Proposition 65 related items.



# cereal dispensers



22067-1-99



3434-99



## A. MADERA CEREAL DISPENSER

Features Pull & Serve Mechanism.  
600 Cubic Inch Capacity Per Bin.

ITEM 3434-99 | 18Wx14½Dx24H

ITEM 22067-1-99 | 6½Wx9¼Dx24¼H **NEW**

22067-1-83



3823-83



## B. SIERRA CEREAL DISPENSER

Features Pull & Serve Mechanism.  
600 Cubic Inch Capacity Per Bin.

ITEM 3909-84 | 18Wx10Dx24H

## C. ASHWOOD CEREAL DISPENSER

Features Pull & Serve Mechanism.  
600 Cubic Inch Capacity Per Bin.

ITEM 3823-83 | 17½Wx9½Dx24H

ITEM 22067-1-83 | 6½Wx9¼Dx24H **NEW**

Please visit [www.calmil.com/legal](http://www.calmil.com/legal) for a complete list of California Proposition 65 related items.





**D. CINDERWOOD  
CEREAL DISPENSER**  
Features Pull & Serve Mechanism.  
600 Cubic Inch Capacity Per Bin.  
ITEM 3823-87 | 17½Wx9½Dx24H



**E. GRANADA  
CEREAL DISPENSER**  
Features Pull & Serve Mechanism.  
4.5 Liter Capacity Per Cylinder.  
ITEM 4024-85 | 17¼Wx13¼Dx24H



**F. URBAN CEREAL DISPENSER**  
Features Turn & Serve Mechanism.  
4.5 Liter Capacity Per Cylinder.  
Stainless Steel (55).  
ITEM 3626-55 | 18¼Wx10¼Dx27H



**G. PORTION CONTROL  
CEREAL DISPENSER**  
Features Pull & Serve Mechanism.  
600 Cubic Inch Capacity Per Bin.  
ITEM 718 | 17Wx13½Dx22H

Please visit [www.calmil.com/legal](http://www.calmil.com/legal) for a complete list of California Proposition 65 related items.

**CAL•MIL** | visit us online at: [www.calmil.com](http://www.calmil.com) | call toll-free 800-321-9069



# cereal dispensers



**A. PORTLAND CEREAL DISPENSER**  
 Features Pull & Serve Mechanism.  
 600 Cubic Inch Capacity Per Bin.  
 Specify Color: Black (13), White (15) **NEW**  
 ITEM 4108 | 16WX9DX23½H



**B. ECO MODERN CEREAL DISPENSERS**  
 Features Pull & Serve Mechanism.  
 942 Cubic Inch Capacity.  
 ITEM 1499 | 18¼Wx13¼Dx24½H | Bamboo



**C. ECO MODERN CEREAL DISPENSERS**  
 Features Pull & Serve Mechanism.  
 942 Cubic Inch Capacity.  
 ITEM 1499-15 | 18¼Wx13¼Dx24½H | White

Please visit [www.calmil.com/legal](http://www.calmil.com/legal) for a complete list of California Proposition 65 related items.



**D. SILVER BULK CEREAL DISPENSER**  
 Features Pull & Serve Mechanism.  
 942 Cubic Inch Capacity.  
 ITEM 4300 | 17½Wx9½Dx24H



**E. MONTEREY CEREAL DISPENSER **NEW****  
 Features Pull & Serve Mechanism.  
 600 Cubic Inch Capacity Per Bin.  
 ITEM 22046-13 | 17¼Wx10½Dx23½H  
 ITEM 22067-1-13 | 6½Wx9¼Dx24H



**F. LUXE CEREAL DISPENSER**  
 4.5 Liter Capacity Per Cylinder.  
 Stainless Steel Trim (55).  
 ITEM 3598-3-55 | 20½Wx7¼Dx27H



Brass (46)



Chrome (49)

**G. MID-CENTURY CEREAL DISPENSERS**  
 Features Turn & Serve Mechanism.  
 4.5 Liter Capacity Per Cylinder.  
 Specify Color: Brass (46), Chrome (49).  
 ITEM 3720 | 19½Wx12Dx28½H



# cereal dispensers



A



B

## A. ROTATING CEREAL DISPENSER

Features Turn and Serve Mechanism.  
4 Cylinders Total, 3.5 Liter Per Cylinder.  
Black (13).

ITEM 22004-4-13 | 13½DIAx18H

## B. MISSION CEREAL DISPENSER

4.5 Liter Capacity Per Cylinder.  
Features Turn & Serve Mechanism.

ITEM 3597-3-13 | 19½Wx10½Dx26H

## C. MADERA CEREAL DISPENSERS

Specify Mechanism & Liter Capacity.  
4.5 LITER (PER CYLINDER ) TURN & SERVE

ITEM 3584-1-99 | 8Wx9½Dx26½H

ITEM 3584-2-99 | 11Wx8¾Dx26½H

ITEM 3584-3-99 | 19¼Wx9¾Dx26½H

5 LITER (PER CYLINDER ) FREE FLOW

ITEM 3576-1-99FF | 8Wx9½Dx26½H

ITEM 3576-2-99FF | 11Wx8¾Dx26½H

ITEM 3576-3-99FF | 19¼Wx9¾Dx26½H



C



Please visit [www.calmil.com/legal](http://www.calmil.com/legal) for a complete list of California Proposition 65 related items.



**D. WALL MOUNT CEREAL DISPENSERS**

5 Liter Capacity Per Cylinder.  
Mounting Hardware Not Included.

**TURN AND SERVE**

ITEM 3518-3-39 | 18½Wx6¾Dx19¾H

ITEM 3518-5-39 | 31Wx6¾Dx19¾H

**FREE FLOW**

ITEM 3518-3-39FF | 18½Wx6¾Dx19¾H

ITEM 3518-5-39FF | 31Wx6¾Dx19¾H

**E. WALL MOUNT 5 CYLINDER DISPENSER**

Features Turn and Serve Mechanism.  
4.5 Liter Capacity Per Cylinder.  
Mounting Hardware Not Included.

ITEM 3520-5-39 | 27½Wx6½Dx21¾H



**F. 2 CYLINDER CEREAL DISPENSERS**

5 Liter Capacity Per Cylinder.  
Black (13), Beechwood (98).

**TURN AND SERVE**

ITEM 3516-2-13 | 12¾Wx11Dx25¾H

ITEM 3516-2-98 | 12¾Wx11Dx25¾H

**FREE FLOW**

ITEM 3516-2-13FF | 12¾Wx11Dx25¾H

ITEM 3516-2-98FF | 12¾Wx11Dx25¾H

**G. 3 AND 5 CYLINDER CEREAL DISPENSERS**

5 Liter Capacity Per Cylinder.  
Black (13), Beechwood (98).

**TURN AND SERVE**

ITEM 3516-3-13 | 19Wx11Dx25¾H

ITEM 3516-3-98 | 19Wx11Dx25¾H

ITEM 3516-5-13 | 31¼Wx11Dx25¾H

ITEM 3516-5-98 | 31¼Wx11Dx25¾H

**FREE FLOW**

ITEM 3516-3-13FF | 19Wx11Dx25¾H

ITEM 3516-3-98FF | 19Wx11Dx25¾H

ITEM 3516-5-13FF | 31¼Wx11Dx25¾H

ITEM 3516-5-98FF | 31¼Wx11Dx25¾H



Please visit [www.calmil.com/legal](http://www.calmil.com/legal) for a complete list of California Proposition 65 related items.



# cereal dispensers



**A. 2 CYLINDER DISPENSER**  
3.5 Liter Capacity Per Cylinder.  
ITEM 3510-2-39 | 12¼Wx6Dx17¾H



**B. 3 CYLINDER DISPENSER**  
ITEM 3510-3-39 | 18½Wx6Dx17¾H | 3.5 Liter  
ITEM 3517-3-39 | 18½Wx6Dx22½H | 5 Liter



**C. ROTATING CEREAL DISPENSER**  
4 Cylinders Total, 3.5 Liter Per Cylinder.  
ITEM 3514-4-39 | 13½DIAx17¾H



**D. ROTATING FREE FLOW DISPENSER**  
Features Free Flow Mechanism.  
5 Liter Capacity Per Cylinder.  
ITEM 3619-4-13FF | 15DIAx24H



**E. FREESTANDING SINGLE FREE FLOW DISPENSER NEW**  
Features Free Flow Mechanism.  
5 Liter Capacity Per Cylinder.  
ITEM 22105-13 | 8Wx6Dx21¾



**F. WALL MOUNT SINGLE DISPENSER**  
3.5 Liter Capacity.  
Hardware Not Included.  
ITEM 3512-1-39 | 6Wx6Dx12¼H



Please visit [www.calmil.com/legal](http://www.calmil.com/legal) for a complete list of California Proposition 65 related items.

**G. REVOLVING CEREAL CUP DISPENSER**

ITEM 1539-12 | 10Wx10Dx16¾H



**H. MISSION BLACK WIRE MERCHANDISER**

ITEM 1702-13 | 13½Wx15Dx16½H



**I. TURNTABLE CEREAL DISPENSER**

ITEM 723 | 12Wx12Dx20H | ABS Base

**J. STACKABLE BULK CEREAL DISPENSER**

450 Cubic Inch Capacity.  
Scoop is Included.

ITEM 656 | 10Wx8Dx14H



**K. BAMBOO CHILLED CONDIMENT JAR DISPLAY**

Includes Base, Jars, Lids, and Cold Pucks.  
Place Pucks in Freezer for a Minimum of 6 Hours.  
Keeps Contents Cold for Hours!

ITEM 1850-4-60 | 16Wx6Dx4H

ITEM 1850-4-60HL | 16Wx6Dx4H



**L. MULTI-LEVEL CHILLED CONDIMENT DISPLAY**

Complete Set with Cold Pucks.  
Place Pucks in Freezer for a Minimum of 6 Hours.  
Keeps Contents Cold for Hours!

SPECIFY LID TYPE

16 OZ. JAR UNITS (14WX11DX11¼H)

ITEM 1855-4-55 | w/ Solid S/S Lids

ITEM 1855-4-55HL | w/ Hinged S/S Lids

ITEM 1855-4-55NL | w/ Notched S/S Lids

32 OZ. JARS UNITS (16WX12DX11¼H)

ITEM 1855-5-55 | w/ Solid S/S Lids

ITEM 1855-5-55HL | w/ Hinged S/S Lids

ITEM 1855-5-55NL | w/ Notched S/S Lids

K



**M. CHILLED CONDIMENT DISPLAY**

Complete Set with Cold Pucks.  
Place Pucks in Freezer for a Minimum of 6 Hours.  
Keeps Contents Cold for Hours!

SPECIFY LID TYPE

16 OZ. JAR UNITS (13¾Wx5Dx4¾H)

ITEM 1850-4-55 | w/ Solid S/S Lids

ITEM 1850-4-55HL | w/ Hinged S/S Lids

ITEM 1850-4-55NL | w/ Notched S/S Lids

32 OZ. JAR UNITS (16½Wx6Dx5¾H)

ITEM 1850-5-55 | w/ Solid S/S Lids

ITEM 1850-5-55HL | w/ Hinged S/S Lids

ITEM 1850-5-55NL | w/ Notched S/S Lids

M



L



Please visit [www.calmil.com/legal](http://www.calmil.com/legal) for a complete list of California Proposition 65 related items.



# bulk dispensers



## A. WALL MOUNT 5 CYLINDER DISPENSER

Features Free Flow Mechanism. 5 Liter Capacity Per Cylinder. Mounting Hardware Not Included.

ITEM 3518-5-39FF | 31Wx6¾Dx19¾H

## B. WALL MOUNT 3 CYLINDER DISPENSER

Features Free Flow Mechanism. 5 Liter Capacity Per Cylinder. Mounting Hardware Not Included.

ITEM 3518-3-39FF | 18½Wx6¾Dx19¾H

## C. WALL MOUNT BULK CEREAL DISPENSER **NEW**

Features Free Flow Mechanism. 9 Liter Capacity Per Cylinder. Mounting Hardware Not Included.

ITEM 3618-5-39FF | 31Wx6½Dx38H



Manually select the size of the dispenser's opening to ensure perfect portion sizes for food of various sizes.



Please visit [www.calmil.com/legal](http://www.calmil.com/legal) for a complete list of California Proposition 65 related items.



**A. WALL MOUNT  
POWDER & TEA DISPENSERS**

Portion Controlled Dispenser Includes  
5 Interchangeable Portion Cassettes from 2-7 Tsp.  
Wall Mounting Hardware Not Included.

**POWDER**

ITEM 3531-1-13 | 6¼Wx7¾Dx9½H | 1.5 Liter

ITEM 3521-1-13 | 6Wx6Dx16H | 5 Liter

**TEA**

ITEM 3533-1-13 | 6¼Wx7¾Dx9½H | 1.5 Liter

ITEM 3523-1-13 | 6Wx6Dx16H | 5 Liter

Portion:  
Two to Seven  
Teaspoons



**B. FREESTANDING POWDER &  
TEA DISPENSERS**

Portion Controlled Dispenser Includes  
5 Interchangeable Portion Cassettes from 2-7 Tsp.

**POWDER**

ITEM 3522-1-13 | 6Wx8Dx16¼H | 1.5 Liter

ITEM 3532-1-13 | 6Wx8Dx23H | 5 Liter

**TEA**

ITEM 3524-1-13 | 6Wx8Dx16¼H | 1.5 Liter

ITEM 3534-1-13 | 6Wx8Dx23H | 5 Liter

**PRODUCT FEATURES:**

- Adjustable Portion Control
- Hygienic
- Elegant Design
- User Friendly
- Maintains Freshness

**SUGGESTED SECTORS:**

- Gyms
- Juice Bars
- Vitamin Shops
- Smoothie & Shake Bars
- Protein Powder Manufacturers
- Health & Fitness Stores
- Kitchens

SEE IN ACTION!



Please visit [www.calmil.com/legal](http://www.calmil.com/legal) for a complete list of California Proposition 65 related items.

CAL•MIL | visit us online at: [www.calmil.com](http://www.calmil.com) | call toll-free 800-321-9069

powder & tea dispensers



# click condiment dispensers



## CLICK CONDIMENT DISPENSERS ARE THE PERFECT SOLUTION

for storing, displaying, and dispensing powders including instant coffee, powdered coffee creamer, sugar, spices, drink mixes, and more! A simple click activates the dispenser's release function, serving you an exact teaspoon every time!



Smart portion control dispensing mechanisms imbedded in stylish and elegant dispensers.

SEE IN ACTION!



### A. DOUBLE OR TRIPLE WALL MOUNT CLICK DISPENSER

Mounting Hardware Not Included.  
1 Liter Capacity Per Cylinder.  
1 Click Dispenses an Exact Teaspoon.

ITEM 3526-2-13 | 10 $\frac{1}{4}$ Wx7 $\frac{1}{4}$ Dx12H | Sugar/1 Powder

ITEM 3526-3-13 | 15 $\frac{3}{4}$ Wx7 $\frac{1}{4}$ Dx12H | Sugar/2 Powder



### B. FREESTANDING CLICK DISPENSERS

1 Liter Capacity Per Cylinder.  
1 Click Dispenses an Exact Teaspoon.

ITEM 3527-1-13 | 5 $\frac{1}{4}$ Wx7 $\frac{1}{4}$ Dx17 $\frac{3}{4}$ H | Single Sugar Dispenser

ITEM 3527-2-13 | 10 $\frac{1}{4}$ Wx7 $\frac{1}{4}$ Dx17 $\frac{3}{4}$ H | 1 Sugar/1 Powder

ITEM 3527-3-13 | 15 $\frac{3}{4}$ Wx7 $\frac{1}{4}$ Dx17 $\frac{3}{4}$ H | 1 Sugar/2 Powder

Please visit [www.calmil.com/legal](http://www.calmil.com/legal) for a complete list of California Proposition 65 related items.



**A. PRESTIGE PORCELAIN  
3 TIER SQUARE INCLINE DISPLAY**

Includes 3 Plates.  
Cold Concept Sold Separately.  
Specify Color: Black (13), Platinum (39).

ITEM PP2301 | 16Wx26Dx22H

ITEM PP252 | Replacement Platter

**OPTIONAL COLD CONCEPT** ❄️

Includes 1 Cold Pack and Liner.  
Place Cold Pack in Freezer for  
a Minimum of 6 Hours Keeps  
Contents Cold for 2-3 Hours.

ITEM 3065 | Cold Pack and Liner

**B. PRESTIGE PORCELAIN  
SQUARE PEDESTAL DISPLAY**

Includes 3 Plates.  
Cold Concept Sold Separately.

ITEM PP1600-13 | 34Wx16Dx9H

ITEM PP252 | Replacement Platte

**OPTIONAL COLD CONCEPT** ❄️

Includes 1 Cold Pack and Liner.  
Place Cold Pack in Freezer for  
a Minimum of 6 Hours Keeps  
Contents Cold for 2-3 Hours.

ITEM 3065 | Cold Pack and Liner

**C. PRESTIGE PORCELAIN  
2 TIER CURVED METAL DISPLAY**

Includes 2 Bowls.  
Cold Concept Sold Separately.

ITEM PP302-13 | 10Wx17Dx9H

ITEM PP351 | Replacement Bowl

**OPTIONAL COLD CONCEPT** ❄️

Includes 1 Cold Pack and Liner.  
Place Cold Pack in Freezer for  
a Minimum of 6 Hours Keeps  
Contents Cold for 2-3 Hours.

ITEM 3066 | Cold Pack and Bowl Liner

❄️ SEE COLD CONCEPT PAGE 192.

Please visit [www.calmil.com/legal](http://www.calmil.com/legal) for a complete list of California Proposition 65 related items.

**CAL•MIL** | visit us online at: [www.calmil.com](http://www.calmil.com) | call toll-free 800-321-9069



# porcelain displays

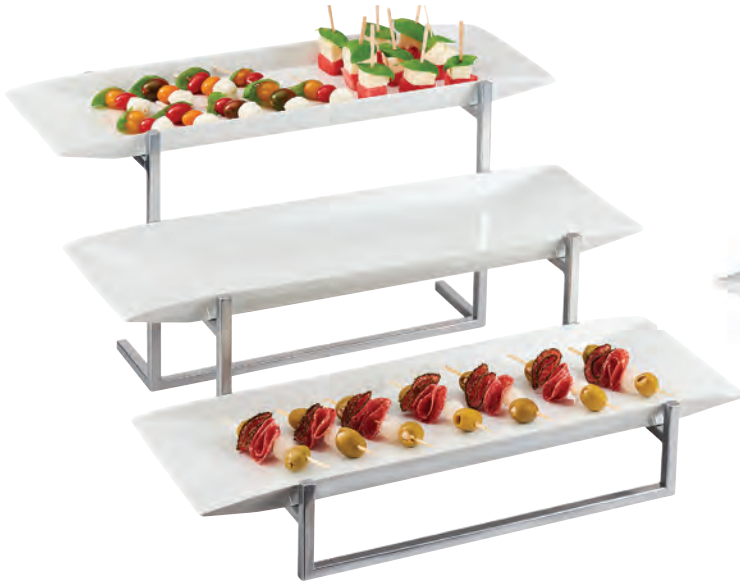

## A. PORCELAIN 3 PLATTER DISPLAY

Includes 3 Platters. Chrome (49).

ITEM PP3661-49 | 23Wx24½Dx12H

ITEM PP152 | Replacement Platter



## B. PRESTIGE PORCELAIN 3 TIER PLATTER DISPLAY

Includes 3 Platters.

Specify Color: Black (13), Platinum (39).

ITEM PP103 | 22Wx12Dx12H

### REPLACEMENT PLATTERS

ITEM PP150 | Small Replacement Platter

ITEM PP151 | Medium Replacement Platter

ITEM PP152 | Large Replacement Platter



## C. PRESTIGE PORCELAIN WIDE FRAME 3 TIER DISPLAY

Includes 3 Platters.

Specify Color: Black (13), Platinum (39).

ITEM PP1033 | 23Wx18Dx12H

ITEM PP152 | Replacement Platter



## D. PRESTIGE PORCELAIN 4 TIER DISPLAY

Includes 4 Bowls.

Specify Color: Black (13), Platinum (39).

ITEM PP2000 | 7Wx19Dx9H

ITEM PP1151 | Replacement Bowl

Please visit [www.calmil.com/legal](http://www.calmil.com/legal) for a complete list of California Proposition 65 related items.



**E. PORCELAIN BEVERAGE DISPENSER**  
Includes Drip Tray and Chalkboard Sign w/ Chain.  
1.5 Gallon Capacity.  
ITEM 3460-1-13 | 10Wx10Dx18H  
ITEM 3550 | Replacement Chalkboard Sign  
ITEM 3062-15 | White Chalkboard Pen



**F. PORCELAIN LONG PLATTERS**  
ITEM PP150 | 18Wx3Dx1H  
ITEM PP151 | 20Wx5Dx1H  
ITEM PP152 | 23Wx7Dx1H



**G. PORCELAIN OVAL BOWL**  
ITEM PP2150 | 16Wx12Dx5H



**H. PORCELAIN ROUND PLATTER**  
ITEM PP1167 | 12¾DIAx1¼H



**I. PORCELAIN DEEP BOWL**  
ITEM PP250 | 7Wx7Dx3H



**J. PORCELAIN WIDE EDGES SQUARE BOWL**  
ITEM PP351 | 10Wx10Dx3H



**K. PORCELAIN LARGE SQUARE PLATTER**  
ITEM PP252 | 12Wx12Dx1¼H



**L. PORCELAIN CANOE BOWL**  
ITEM PP1151 | 11Wx5Dx2H

**M. PORCELAIN LONG OVAL PLATTER**  
ITEM PP551 | 24Wx8Dx1H





# cold concept systems



Porcelain Plate

Cold Pack

Liner

## A. COLD CONCEPT BASES

Keep Contents Cold for Hours!  
Cold Plates/Bowls Sold Separately.

ITEM 3367-13 | Black Metal | 12Wx12Dx4½H

ITEM 3367-60 | Bamboo | 12Wx12Dx4½H

ITEM 3367-99 | Madera | 12Wx12Dx5¾H

ITEM 4023-85 | Granada | 12Wx12Dx5¼H

**No Ice?  
No Problem!**  
Keeps Food Cold  
& Fresh For Hours

## B. COLD CONCEPT PORCELAIN PLATE SYSTEM ❄️

Complete Set Includes: Porcelain Plate/Bowl, Cold Pack, and Liner. Place Cold Pack in Freezer for a Minimum of 6 Hours. Keeps Contents Cold for 2-3 Hours. Bases Sold Separately.

ITEM 3063 | Porcelain Plate, Liner, Cold Pack

ITEM 3402 | Hinged Dome Lid



**C. ALUMINUM COLD CONCEPT**  
Wood Frames and Platters Sold Separately.  
Frame Includes Cold Pack and Liner.  
Place Cold Pack in Freezer for a Minimum of 6 Hours.

**FRAMES** ❄️  
Specify Color: White (15),  
Madera (99).

ITEM 3699-915 | 14½Wx10¼Dx3½H

ITEM 3699-623 | 23Wx7¾Dx3½H

ITEM 3699-1123 | 23Wx12½Dx3½H

**ALUMINUM PLATTERS**

ITEM 3672-915 | 15½Wx9½Dx1½H

ITEM 3672-623 | 23½Wx6½Dx1½H

ITEM 3672-1123 | 23½Wx11½Dx1½H



Porcelain Bowl

Cold Pack

Liner

## D. COLD CONCEPT PORCELAIN BOWL SYSTEM ❄️

Complete Set Includes: Porcelain Bowl, Cold Pack, and Liner. Place Cold Pack in Freezer for a Minimum of 6 Hours. Keeps Contents Cold for 2-3 Hours. Bases Sold Separately.

ITEM 3064 | Porcelain Bowl, Liner, Cold Pack

ITEM 3402 | Hinged Dome Lid

Please visit [www.calmil.com/legal](http://www.calmil.com/legal) for a complete list of California Proposition 65 related items.

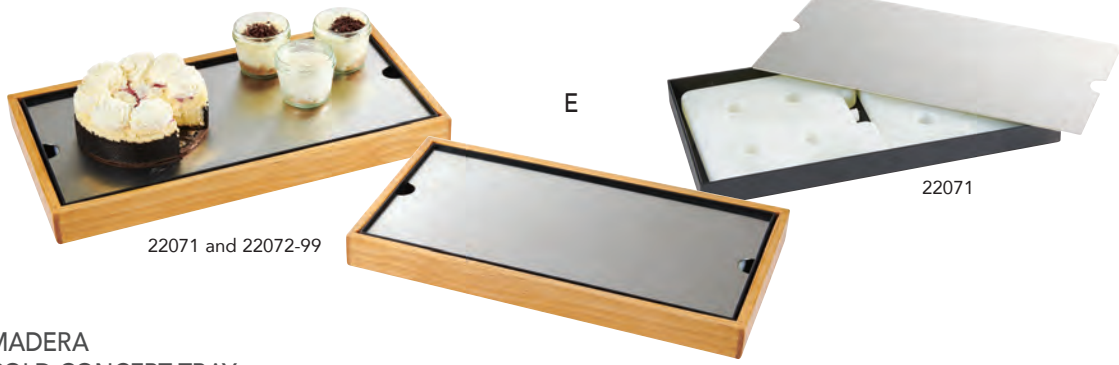

22071 and 22072-99

22071

**E. MADERA  
COLD CONCEPT TRAY NEW**

Madera Frame Sold Separately.  
Cold Concept Set Includes Cold Packs.

ITEM 22071 | 8¾Wx16¾Dx1½H | Cold Set

ITEM 22072-99 | 9¾Wx17¾Dx1¾H | Madera Frame



**F. STAINLESS STEEL  
GEL-FILLED COLD BOWLS ❄️**

Keep Gel-Filled Bowl in Freezer for  
Minimum of 6 Hours to Keep Contents  
Cold for Hours!

ITEM 3326-7-55 | 7Wx7Dx4H

ITEM 3326-10-55 | 10Wx10Dx4H

**G. ASHWOOD  
CARAFE COOLERS NEW**

Includes Cold Packs. Carafes Sold Separately.

ITEM 22081-83 | 5¾Wx7½Dx7H | Fits 3551-55

ITEM 22082-83 | 5¼Wx14½Dx7H | Fits 3614-55

ITEM 3551-55 | 4DIAx13H

ITEM 3614-55 | 4DIAx10H

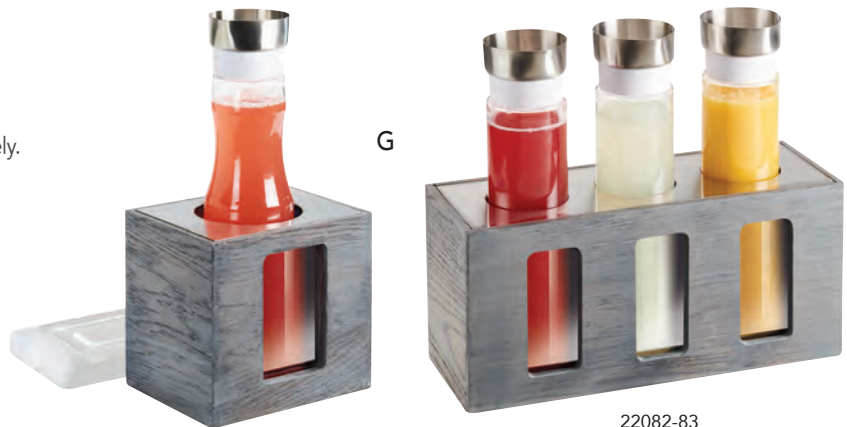

22081-83

22082-83

**H. MADERA  
CARAFE COOLERS NEW**

Includes Cold Packs. Carafes Sold Separately.

ITEM 22081-99 | 5¾Wx7½Dx7H | Fits 3551-55

ITEM 22082-99 | 5¼Wx14½Dx7H | Fits 3614-55

ITEM 3551-55 | 4DIAx13H

ITEM 3614-55 | 4DIAx10H

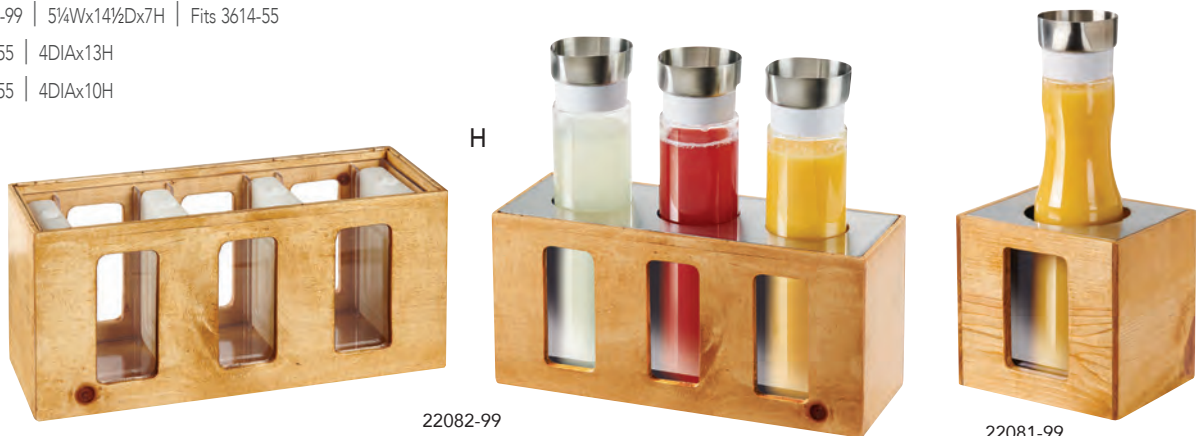

22082-99

22081-99

Please visit [www.calmil.com/legal](http://www.calmil.com/legal) for a complete list of California Proposition 65 related items.

**CAL•MIL** | visit us online at: [www.calmil.com](http://www.calmil.com) | call toll-free 800-321-9069



# melamine displays



## A. MELAMINE 3 TIER INCLINE DISPLAY

Includes 3 Melamine Platters.  
Specify Color: Black (13), Platinum (39).

ITEM SR1033 | 18Wx23Dx12H

ITEM SR152 | Replacement Platter



## B. BLACK LONG PLATTER DISPLAY

Includes 3 Melamine Platters. Black (13).

ITEM SR1520-13 | 24Wx14Dx9H

ITEM SR152 | Replacement Platter



## C. MELAMINE PLATTER DISPLAY

Includes 3 Melamine Platters. Chrome (49).

ITEM SR3661-49 | 23Wx24½Dx12H

ITEM SR152 | Replacement Platter

Please visit [www.calmil.com/legal](http://www.calmil.com/legal) for a complete list of California Proposition 65 related items.

**D. MELAMINE OFFSET  
3 TIER SQUARE DISPLAY**  
Includes 3 Melamine Plates.  
Cold Concept Sold Separately.  
Specify Color: Black (13), Platinum (39).

ITEM SR2301 | 16Wx22Dx26H

**OPTIONAL COLD CONCEPT** ❄️  
Includes 1 Cold Pack and Liner. Place Cold  
Pack in Freezer for a Minimum of 6 Hours.  
Keeps Contents Cold for 2-3 Hours.

ITEM 3065 | Cold Pack and Liner

ITEM SR252 | Replacement Plate



**E. CLEAR COVER FOR PLATTERS**

ITEM DM252 | 12Wx12Dx2H



**F. MELAMINE SQUARE 2 TIER DISPLAY**

Includes 3 Melamine Platters.  
Cold Concept Sold Separately.

ITEM SR1600-13 | 35½Wx18½Dx10½H

**OPTIONAL COLD CONCEPT** ❄️  
Includes 1 Cold Pack and Liner. Place Cold  
Pack in Freezer for a Minimum of 6 Hours.  
Keeps Contents Cold for 2-3 Hours.

ITEM 3065 | Cold Pack and Liner

ITEM SR252 | Replacement Plate



**G. MELAMINE 3 TIER BOWL DISPLAY**

Includes 3 Melamine Bowls.  
Specify Color: Black (13), Platinum (39).

ITEM SR701 | 21Wx18Dx19H

ITEM SR750 | Replacement Bowl



❄️ SEE COLD CONCEPT PAGE 192.

Please visit [www.calmil.com/legal](http://www.calmil.com/legal) for a complete list of California Proposition 65 related items.

**CAL•MIL** | visit us online at: [www.calmil.com](http://www.calmil.com) | call toll-free 800-321-9069



# melamine displays

A



## A. MELAMINE 5 TIER SMALL CANOE DISPLAY

Includes 5 Melamine Small Canoe Bowls.  
Specify Color: Black (13), Platinum (39).

SR303 | 29Wx13Dx16H

SR350 | Replacement Canoe

B



## B. MELAMINE 4 TIER BOWL AND CANOE DISPLAY

Includes 3 Melamine Small Canoe Bowls and 1 Large Bowl.  
Black (13).

ITEM SR801-13 | 17Wx27Dx11H

ITEM SR852 | Replacement Bowl

ITEM SR350 | Replacement Canoe

C



## C. MELAMINE 3 TIER CANOE DISPLAY

Includes 3 Melamine Large Canoe Bowls.  
Specify Color: Black (13), Platinum (39).

ITEM SR304 | 16½Wx18½Dx10½H

ITEM SR351 | Replacement Canoe

## D. UNION SQUARE BOWL DISPLAY

Includes 3 Melamine Bowls.

ITEM 3404-13 | 6½Wx19Dx12H

ITEM SR261 | Replacement Bowl

D



**E. MELAMINE 2 TIER BOWL DISPLAY**

Includes 3 Melamine Bowls. Black (13).

ITEM SR2030-13 | 9Wx25Dx11H

ITEM SR262 | Replacement Bowl



**F. MELAMINE PLATTER AND SQUARE BOWL DISPLAY**

Includes Melamine Bowls and Platter. Black (13).

ITEM SR1020-13 | 19½Wx19½Dx11H

ITEM SR252 | Replacement Platter

ITEM SR261 | Replacement Bowl



**G. MELAMINE 4 BOWL SQUARE DISPLAY**

Includes Melamine Bowls and Platter.

ITEM SR1010-13 | 19Wx19Dx11H

ITEM SR261 | Small Replacement Bowl

ITEM SR263 | Large Replacement Bowl



**H. OPTIONAL CYLINDERS**

Available in Six Colors.

Stainless Steel Style: Perforated (39), (SOLID).  
Colored Melamine: Black (13), White (15),  
Butter Yellow (61), Terra Cotta (62), Sage (63),  
Cranberry (64). Extra Deep: White (8-15).

ITEM 1017-39 | 4½DIAx5½H

ITEM 1017-SOLID | 4½DIAx5½H

ITEM 1017 | 4½DIAx5½H

ITEM 1017-8-15 | 4½DIAx8H | Extra Deep



Please visit [www.calmil.com/legal](http://www.calmil.com/legal) for a complete list of California Proposition 65 related items.



# melamine displays

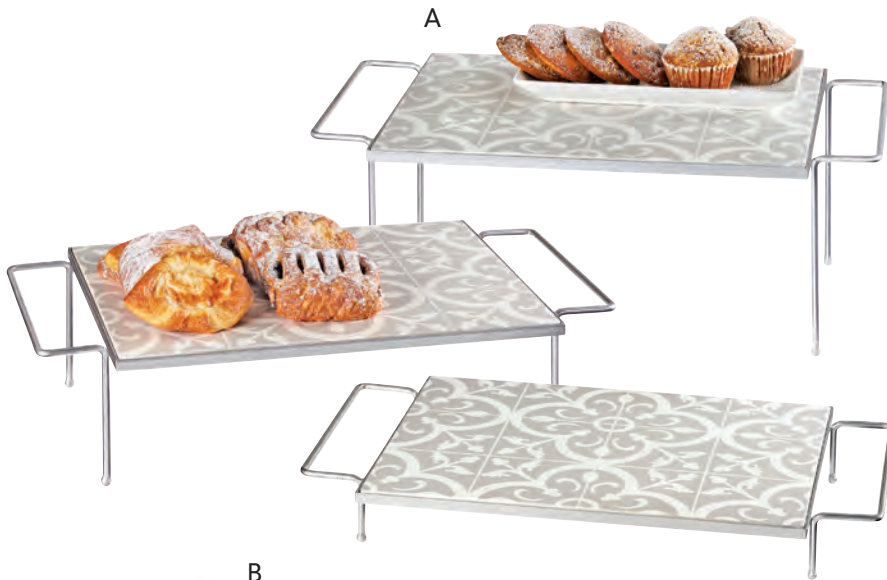

A

- A. GRANADA WIRE RISERS**  
Includes Removable Melamine Tray.  
ITEM 436-3-86 | 24Wx13¾Dx3H  
ITEM 436-6-86 | 24Wx13¾Dx6H  
ITEM 436-9-86 | 24Wx13¾Dx9H

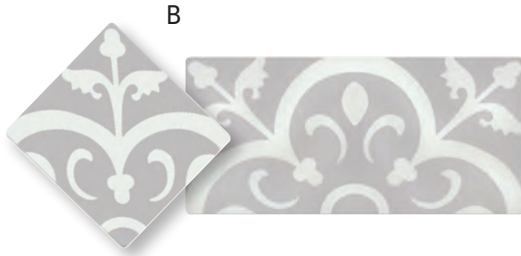

B

- B. GRANADA SERVING TILES**  
ITEM 3732-86 | 6Wx6Dx¾H  
ITEM 3731-86 | 12Wx6Dx¾H



C

- C. CARRARA MARBLE  
MELAMINE TRAYS**  
Marble Melamine (81M).  
ITEM 3629-712-81M | 7Wx12Dx¾H  
ITEM 3629-1511-81M | 14¾Wx10¾Dx¾H  
ITEM 3629-1813-81M | 18Wx13Dx¾H  
ITEM 3656-12-81M | 12DIAx¾H  
ITEM 3656-15-81M | 15DIAx¾H



D

- D. WIRE CONDIMENT DISPLAY**  
Includes 3 Melamine Jars.  
Specify Color: Black (13), White (15).  
ITEM 22012 | 15½Wx4½Dx6½H  
ITEM C1432BODY | Replacement Jar  
ITEM C1432BODYC | Replacement Jar | Write On



E

- E. 32 OZ. MELAMINE COLD JAR**  
Includes 1 Cold Puck. Keep Cold Pack  
in Freezer for Minimum of 6 Hours to  
Keep Contents Chilled for Hours!  
ITEM 3050-32 | 5DIAx5½H



F

- F. WHIPPED CREAM COOLER**  
Includes 4 Stackable Cold Packs. Keep Cold  
Packs in Freezer for Minimum of 6 Hours  
to Keep Contents Chilled for Hours!  
ITEM 3399 | 5Wx5Dx4¾H

Please visit [www.calmil.com/legal](http://www.calmil.com/legal) for a complete list of California Proposition 65 related items.



**G. MELAMINE  
LONG PLATTER**

ITEM SR152 | 23Wx7Dx1H



**H. MELAMINE  
ROUND BOWLS**

ITEM SR850 | 11DIAx4H

ITEM SR851 | 13DIAx5H

ITEM SR852 | 15DIAx6H



**I. MELAMINE  
SQUARE BOWLS**

ITEM SR261 | 8Wx8Dx5H

ITEM SR262 | 10Wx10Dx5H

ITEM SR263 | 12Wx12Dx5H



**J. MELAMINE  
LARGE OVAL BOWL**

ITEM SR950 | 12Wx15Dx2H



**K. MELAMINE  
CANOE BOWL**

ITEM SR350 | 12Wx4Dx2H

ITEM SR351 | 16Wx6Dx3H



**L. MELAMINE  
LARGE SQUARE PLATTER**

ITEM SR252 | 11¾Wx11¼Dx1½H



**M. MELAMINE EXTENDED  
BASE ROUND BOWL**

ITEM SR750 | 10Wx11Dx6H



**N. MELAMINE ROUND  
PLATES **NEW****

Specify Color: White (15),  
Stoneware (89).

ITEM 22017-8 | 8¼DIAx1½H

ITEM 22017-10 | 10DIAx1½H

ITEM 22017-12 | 12DIAx1½H



**O. MELAMINE ROUND  
BOWLS **NEW****

Specify Color: White (15),  
Stoneware (89).

ITEM 22013-10 | 10DIAx4½H



**P. MELAMINE PLATTERS **NEW****

Specify Color: White (15),  
Stoneware (89).

ITEM 22018 | 14Wx11¼Dx1H



**Q. MELAMINE CURVED BOWL**

ITEM 3676-15 | 6Wx6Dx3½H



**R. EXTRA DEEP WHITE CYLINDER**

ITEM 1017-8-15 | 4½DIAx8H



# melamine displays

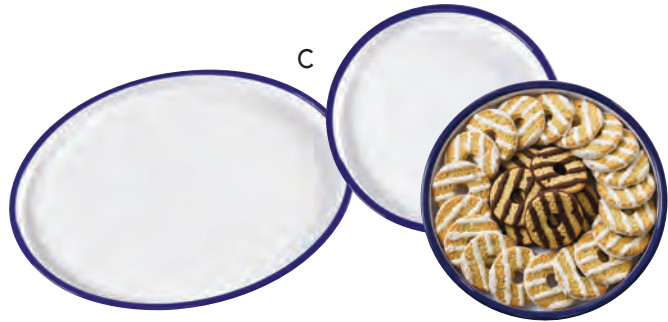

## A. MELAMINE ENAMELWARE DEEP TRAYS

ITEM 3470-15 | 12Wx7Dx2H  
 ITEM 3464-15 | 12Wx10Dx2H  
 ITEM 3465-15 | 15Wx12Dx2H

## B. MELAMINE BOWLS LARGE BOWLS

ITEM 3343-8-15 | 8½DIAx3¾H  
 ITEM 3343-10-15 | 10¼DIAx5H

## SMALL BOWLS

ITEM 3467-4-15 | 4½DIAx1¼H  
 ITEM 3467-5-15 | 5½DIAx5H

## C. MELAMINE ENAMELWARE OVAL/ROUND TRAY **NEW**

ITEM 3477-15 | 9½DIAx1¼H | Round  
 ITEM 3482-15 | 12Wx16Dx1¼H | Oval

## D. MELAMINE ENAMELWARE SERVING TRAY

ITEM 3463-15 | 13Wx9Dx1H | Tray  
 ITEM 3472-15 | 12Wx18Dx1H | Tray  
 ITEM 3467-4-15 | 4½DIAx1¼H | Bowl  
 ITEM 3479-55 | Stainless 2-3 Taco Holder

## E. MELAMINE ENAMELWARE CHIP/FRY HOLDER

ITEM 3462-15 | 3½DIAx5H

## F. MELAMINE MODULAR SERVING TRAYS **NEW**

All Trays Are Stackable and Can Be Arranged Together in Countless Variations.  
 Specify Color: Black (13), White (15), Wood (91).

ITEM 22097 | 4Wx4Dx1½H  
 ITEM 22098 | 4Wx8Dx1½H  
 ITEM 22099 | 9Wx9Dx1½H  
 ITEM 22100 | 13Wx9Dx1½H

Please visit [www.calmil.com/legal](http://www.calmil.com/legal) for a complete list of California Proposition 65 related items.

**G. MELAMINE ROUND BOWLS**  
SPECIFY COLOR: BLACK (13), WHITE (15)

ITEM 418-8 | 8" Round Bowl

ITEM 418-10 | 10" ROUND BOWL



**H. FAUX SLATE BOWLS**

Black Slate Melamine (65M).

ITEM 3498-5-65M | 5Wx5Dx3H

ITEM 3498-8-65M | 8Wx8Dx3¾H

ITEM 3498-10-65M | 9½Wx9½Dx4H



**I. MELAMINE ROUND JARS**

Write-On Label is Commercial Grade,  
Scratch and Dent Proof!

**WHITE AND BLACK JARS**

Specify Color: Black (13), White (15).

ITEM 1950-16 | 4DIAx4¼H | 16 oz.

ITEM 1950-32 | 5DIAx5½H | 32 oz.

ITEM 1950-64 | 6¾DIAx6¼H | 64 oz.

**WRITE-ON**

ITEM 1950-16-15C | 4DIAx4¼H | 16 oz.

ITEM 1950-32-15C | 5DIAx5½H | 32 oz.

ITEM 1950-64-15C | 6¾DIAx6¼H | 64 oz.



**J. MELAMINE SQUARE JARS**

**SQUARE WHITE ONLY**

ITEM C1432BODY | 4Wx4Dx4H | Jar Only

ITEM 1432-15 | 4Wx4Dx4H | w/ Full Lid

ITEM 1432-15N | 4Wx4Dx4H | w/ Notched Lid

**SQUARE WRITE-ON**

ITEM C1432BODYC | 4Wx4Dx4H | Jar Only

ITEM 1432-15C | 4Wx4Dx4H | w/ Full Lid

ITEM 1432-15N-C | 4Wx4Dx4H | w/ Notched Lid



**K. MELAMINE  
STONEWARE SERVINGWARE**

ITEM 3471-5 | 5½DIAx4H

ITEM 3471-9 | 9DIAx3H

ITEM 3471-12 | 12Wx9Dx3¾H





# covers & trays



## A. MADERA CAKE STANDS **NEW**

Covers Sold Separately.

ITEM 4310-5-99 | 12¾DIAx5H

ITEM 4310-7-99 | 12¾DIAx7H

ITEM 4310-9-99 | 12¾DIAx9H

ITEM P311 | 12DIAx9H | Cover in Image Above

## B. CAKE/PIE COVERS

ITEM P313 | 12DIAx4H

ITEM P302 | 12DIAx6H

ITEM P311 | 12DIAx9H

## C. STAINLESS STEEL CAKE STAND

ITEM 1308 | 12DIAx7H

## D. CAKE/PIE TRAYS & PEDESTALS

ITEM P306 | 12DIAx1H

ITEM P308 | 12DIAx5H



Please visit [www.calmil.com/legal](http://www.calmil.com/legal) for a complete list of California Proposition 65 related items.

**E. SHALLOW AND DEEP TRAYS**

**SHALLOW TRAYS**

Specify Color: Clear (12) or Black (13).

ITEM 315-10 | 10DIAx1H

ITEM 315-12 | 12DIAx1H

ITEM 315-15 | 15DIAx1H

**DEEP TRAYS**

ITEM 316-10-12 | 10DIAx2½H | Clear

ITEM 316-12-12 | 12DIAx3½H | Clear

ITEM 316-12-13 | 12DIAx3½H | Black

ITEM 316-15 | 15DIAx3½H | Clear



**F** 22058-12-12



22057-14-12

22057-12-12

**F. POLYCARBONATE**

**COVERS AND PEDESTALS NEW**

ITEM 22057-12-12 | 11¼DIAx4H | Pedestal Holds 22058-11-12

ITEM 22058-11-12 | 11DIAx8¾H | Cover Fits 22057-12-12

ITEM 22057-14-12 | 13½DIAx5H | Pedestal Holds 22058-12-12

ITEM 22058-12-12 | 12¼DIAx9¼H | Cover Fits 22057-12-12

**G. LIFT & SERVE**

**CLEAR GOURMET COVER**

ITEM 150-10 | 10DIAx6H

ITEM 150-12 | 12DIAx7H

ITEM 150-15 | 15DIAx9H



**H**



**H. COLONIAL CLEAR COVERS**

ITEM 312-10 | 10DIAx5½H

ITEM 312-12 | 12DIAx6H

ITEM 312-15 | 15DIAx7H

**I. GOURMET CLEAR COVERS**

ITEM 311-7 | 7DIAx4H

ITEM 311-10 | 11¼DIAx6½H

ITEM 311-12 | 12DIAx7H

ITEM 311-15 | 15DIAx9H



**J**



**J. BLACK CONE PEDESTALS**

ITEM 482-15-13 | 12DIAx5H

**K. SQUARE CHILL SAMPLER**

Complete Set Includes Cold Pack, Plate, and Liner! Stainless Steel (55).

ITEM 3329-12-55 | 12Wx13Dx7½H



**L**



**L. ROUND CHILL SAMPLER**

Complete Set Includes Cold Pack, Plate, and Liner! Stainless Steel (55).

ITEM 3328-12-55 | 12DIAx7½H

Please visit [www.calmil.com/legal](http://www.calmil.com/legal) for a complete list of California Proposition 65 related items.



# covers & trays



## A. TURN N SERVE® CLEAR GOURMET COVER

- ITEM 301-10 | 10DIAx4½H
- ITEM 301-12 | 12DIAx5½H
- ITEM 301-15 | 15DIAx7H
- ITEM 301-18 | 18DIAx8H



## C. TURN N SERVE® CLEAR COLONIAL COVER

- ITEM 302-10 | 10DIAx4½H
- ITEM 302-12 | 12DIAx5¾H
- ITEM 302-15 | 5DIAx7H



## B. SHALLOW TRAYS

Specify Color: Clear (12), Black (13), or White (15).

- |  |  |
|--|--|
| ITEM 325-9   9Wx26Dx1H   N/A in Black or White | ITEM 325-18   18Wx26Dx1H   N/A in White          |
| ITEM 325-10   10Wx12Dx1H   N/A in White        | ITEM 335-10   10Wx14Dx1H   N/A in White          |
| ITEM 325-12   12Wx20Dx1H                       | ITEM 335-12   12Wx18Dx1H   N/A in Black or White |
| ITEM 325-13   13Wx18Dx1H                       |  |

## SLIMLINE CLEAR SHALLOW TRAY

- ITEM P232-12 | 12Wx20Dx1H
- ITEM P235-12 | 18Wx26Dx1H



## D. TURN N SERVE® SHALLOW TRAY

Specify Color: Clear (12) or Black (13).

- ITEM 315-10 | 10DIAx1H
- ITEM 315-12 | 12DIAx1H
- ITEM 315-15 | 15DIAx1H

## E. TURN N SERVE® DEEP TRAY

Clear (12), Black (13).

- ITEM 316-10-12 | 10DIAx2½H
- ITEM 316-12-12 | 12DIAx3½H
- ITEM 316-12-13 | 12DIAx3½H
- ITEM 316-15 | 15DIAx3½H | Clear

Please visit [www.calmil.com/legal](http://www.calmil.com/legal) for a complete list of California Proposition 65 related items.



**F. DOME COVER W/ 2 END CUTS**  
ITEM 323-12 | 12Wx20Dx7½H



**G. DOME COVERS W/ SIDE CUT**  
ITEM 324-10 | 10Wx12Dx4½H  
ITEM 324-12 | 12Wx20Dx7½H  
ITEM 324-18 | 18Wx26Dx8H



**H. DOME COVERS W/ END CUT**  
ITEM 322-10 | 10Wx12Dx4½H  
ITEM 322-12 | 12Wx20Dx7½H  
ITEM 322-18 | 18Wx26Dx8H



**I. DOME COVER W/ FRONT DOOR**  
ITEM 367-10 | 10Wx12Dx4½H  
ITEM 367-12 | 12Wx20Dx7H



**J. DOME COVER W/ END DOOR**  
ITEM 339-12 | 12Wx20Dx7H



**K. DOME COVER W/ DUAL DOORS**  
ITEM 361-12 | 12Wx20Dx7H



**L. PLASTIC ROLL TOP COVER**  
ITEM 1703 | 21Wx13Dx7H



**M. DOME COVERS**  
ITEM 321-10 | 10Wx12Dx4½H  
ITEM 321-12 | 12Wx20Dx7½H  
ITEM 321-18 | 18Wx26Dx8H



**N. STANDARD COVER W/ LONG HINGE**  
ITEM 329-12 | 12Wx20Dx4H  
ITEM 329-13 | 13Wx18Dx4H  
ITEM 329-18 | 18Wx26Dx4H



**O. STANDARD COVER W/CENTER HINGE**  
ITEM 328-12 | 12Wx20Dx4H  
ITEM 328-13 | 13Wx18Dx4H  
ITEM 328-18 | 18Wx26Dx4H  
ITEM 334-12 | 12Wx18Dx4H



**P. STANDARD COVERS**  
ITEM 327-9 | 9Wx26Dx4H  
ITEM 327-12 | 12Wx20Dx4H  
ITEM 327-13 | 13Wx18Dx4H  
ITEM 327-18 | 18Wx26Dx4H

Please visit [www.calmil.com/legal](http://www.calmil.com/legal) for a complete list of California Proposition 65 related items.



# chafers & alternatives



## A. GRANADA CHAFER

Features Easy Access Drawer for Chafer Fuel.  
Includes Stainless Steel Cover.

ITEM 4016-85 | 22Wx14Dx12¼H



## B. PORTLAND CHAFER

Includes Stainless Steel Cover.

ITEM 4113-13 | 22Wx13½Dx12H



## C. PORTLAND CHAFER **NEW**

Includes Stainless Steel Cover.

ITEM 4113-15 | 22Wx13½Dx12H



## D. MID-CENTURY CHAFERS

Features Easy Access Drawer for Chafer Fuel.  
Includes Polished Stainless Steel Cover with  
Self-Closing Lid.

Specify Color: Brass (46), Chrome (49).

ITEM 3705 | 23Wx17½Dx13¾H



## E. ASHWOOD CHAFER

Features Easy Access Drawer for Chafer Fuel.  
Includes Stainless Steel Chafer Cover.

ITEM 3828-83 | 22Wx14Dx13½H

Please visit [www.calmil.com/legal](http://www.calmil.com/legal) for a complete list of California Proposition 65 related items.



**F. MADERA CHAFER**

Features Easy Access Drawer for Chafer Fuel.  
Includes Stainless Steel Chafer Cover.

ITEM 3429-99 | 22Wx14¼Dx12H



**G. MONTEREY CHAFER NEW**

Features Easy Access Drawer for Chafer Fuel.  
Includes Stainless Steel Chafer Cover.

ITEM 22113-15 | 22¼Wx14¼Dx12½H



**H. BAMBOO CHAFER**

Features Easy Access Drawer for Chafer Fuel.  
Includes Stainless Steel Chafer Cover.

ITEM 3821-60 | 22Wx14Dx13H



**I. LUXE CHAFER**

Includes Stainless Steel Chafer Cover.  
Stainless Steel Trim (55).

ITEM 3017-55 | 21¾Wx13¾Dx12H



**J. SIERRA CHAFER**

Features Easy Access Drawer for Chafer Fuel.  
Includes Polished Stainless Steel Cover with  
Self-Closing Lid.

ITEM 3907-84 | 22Wx15Dx14H



**K. CINDERWOOD CHAFER**

Features Easy Access Drawer for Chafer Fuel.  
Includes Stainless Steel Chafer Cover.

ITEM 3828-87 | 22Wx14Dx13½H

Please visit [www.calmil.com/legal](http://www.calmil.com/legal) for a complete list of California Proposition 65 related items.

**CAL•MIL** | visit us online at: [www.calmil.com](http://www.calmil.com) | call toll-free 800-321-9069



# chafers & alternatives



**A. MISSION CHAFER**  
Includes Stainless Steel Chafer Cover.  
ITEM 1368-13 | 21¾Wx13¾Dx15¼H



**B. SQUARED CHAFERS**  
Includes Stainless Steel Chafer Cover.  
ITEM 1613-13 | 23Wx15Dx16H



**C. ONE BY ONE BLACK CHAFERS**  
Includes Stainless Steel Chafer Cover.  
ITEM 3321-13 | 24¾Wx15¼Dx12H



**D. COLLAPSIBLE CHAFERS**  
Includes Stainless Steel Chafer Cover,  
Collapsible Metal Frame and Fuel Cell Rail.  
ITEM 3644-55 | 21Wx13Dx11¼H



**E. ROUND CHAFER**  
Includes Windguard and Self-Closing Cover.  
ITEM 3368-49 | 18Wx21Dx13¾H



**F. BLACK CHAFER BAG**  
Will Fit Any Cal-Mil Chafer For Safer  
Transport.  
ITEM 4015 | 24Wx17Dx13½H

Please visit [www.calmil.com/legal](http://www.calmil.com/legal) for a complete list of California Proposition 65 related items.



**G . BLACK WIRE CHAFER**  
Includes Stainless Steel Chafers Cover.  
ITEM 4118 | 25Wx13Dx12H



**H. CLEAR 3-SIDED CHAFER WINDGUARD**  
Cal-Mil Chafers Have Built-in Windguards, Only Standard Chafers Need These Windguards.  
ITEM 978-12 | 22½Wx14Dx7H



**I. MAGNETIC INDUCTION CHAFER ATTACHMENT**  
Converts Chafers with Easy Access Drawers into Flameless Induction Units. Stainless Steel Piece is Placed in Water Pan, Unit Attaches Magnetically Below.  
ITEM 4011 | 8¼Wx8¼Dx3½H



**J. STAINLESS STEEL CHAFER COVER**  
ITEM 3325-55 | 21Wx13Dx2½H



**K. PLASTIC ROLL TOP COVER**  
ITEM 1703 | 21Wx13Dx7H



**L. CLEAR CHAFER COVERS W / DOOR**  
ITEM 367-10 | 10Wx12Dx4½H  
ITEM 367-12 | 12Wx20Dx7H



**M. CHAFER COVER W / DUAL DOORS**  
361-12 | 12Wx20Dx7H



**N. CLEAR CHAFER COVER W / DOOR**  
ITEM 339-12 | 12Wx20Dx7H



**O. CHAFER COVER W / DUAL CUTOUTS**  
323-12 | 12Wx20Dx7½H



**P. CLEAR CHAFER COVERS W / CUTOUT**  
322-10 | 10Wx12Dx4½H  
322-12 | 12Wx20Dx7½H



**Q. CHAFER COVERS W / CUTOUT**  
ITEM 324-10 | 10Wx12Dx4½H  
ITEM 324-12 | 12Wx20Dx7½H

CAUTION: Chafers Covers Are Not Warranted For Steam Table Use. Extremely Hot. Do Not Expose To Direct Flame.

Please visit [www.calmil.com/legal](http://www.calmil.com/legal) for a complete list of California Proposition 65 related items.

**CAL•MIL** | visit us online at: [www.calmil.com](http://www.calmil.com) | call toll-free 800-321-9069



# chafers & alternatives



## A. MADERA CHAFER ALTERNATIVES

ITEM 3440-99 | 10¼Wx10Dx5½H

ITEM 3439-99 | 19¾Wx10Dx5¾H



## B. EMPIRE CHAFER ALTERNATIVES **NEW**

ITEM 22084-90 | 10Wx10¼Dx7½H

ITEM 22083-90 | 10Wx19¼Dx7½H



## C. MID-CENTURY CHAFER ALTERNATIVES

Specify Color: Brass (46), Chrome (49).

ITEM 3711 | 10¼Wx10Dx7¼H

ITEM 3722 | 19¾Wx10Dx7½H



## D. BAMBOO CHAFER ALTERNATIVES

Griddle for 3439-99 Sold Separately.

ITEM 3440-60 | 10¼Wx10Dx5½H

ITEM 3439-60 | 19¾Wx10Dx5½H



## E. GRIDDLE OPTIONS

ITEM 1362 | 22¾Wx13¾Dx2¼H | w/Brackets

ITEM 3067 | 22¾Wx13¾Dx2¼H | w/Heat Guard Handles



## F. IRON CHAFER ALTERNATIVES

ITEM 1361-12 | 10¼Wx10Dx7½H

ITEM 1361-22 | 19¾Wx10Dx7½H

Please visit [www.calmil.com/legal](http://www.calmil.com/legal) for a complete list of California Proposition 65 related items.



**G. CLASSIC CHAFER ALTERNATIVE**  
 Made with Built in Wind guard and Securely Holds up to 12" Diameter Pans.  
 1344-7-13 | 12½DIAx7¼H  
 1344-10-13 | 12½DIAx10H



**H. PORTLAND CHAFER ALTERNATIVES**  
 ITEM 4106-13 | 10¼Wx10Dx7½H | Black  
 ITEM 4107-13 | 19¾Wx10Dx5¾H | Black  
 ITEM 4106-15 | 10¼Wx10Dx7½H | White **NEW**  
 ITEM 4107-15 | 19¾Wx10Dx5¾H | White **NEW**



**I. SIERRA CHAFER ALTERNATIVES**  
 ITEM 3916-84 | 10¼Wx10Dx7¼H  
 ITEM 3917-84 | 19¾Wx10Dx7¼H



**J. CINDERWOOD CHAFER ALTERNATIVES**  
 ITEM 3814-87 | 10¼Wx10Dx5½H  
 ITEM 3813-87 | 19¾Wx10Dx5½H



**K. URBAN CHAFER ALTERNATIVES**  
 Stainless Steel Trim (55).  
 ITEM 3407-55 | 10¼Wx10Dx8¼H  
 ITEM 3391-55 | 19¾Wx10Dx9½H



**L. ASHWOOD CHAFER ALTERNATIVES**  
 ITEM 3814-83 | 10¼Wx10Dx5½H  
 ITEM 3813-83 | 19¾Wx10Dx5½H

Please visit [www.calmil.com/legal](http://www.calmil.com/legal) for a complete list of California Proposition 65 related items.



# chafers & alternatives



## A. MONTEREY CHAFER ALTERNATIVES **NEW**

ITEM 22044-15 | 10Wx10Dx6¾H

ITEM 22043-15 | 19¾Wx10Dx6¾H



## B. GRANADA CHAFER ALTERNATIVES

ITEM 4020-85 | 10¼Wx10Dx5½H

ITEM 4021-85 | 19¾Wx10Dx5½H



## C. SQUARED CHAFER ALTERNATIVES

Specify Color: Black (13), Stainless Steel (55).

ITEM 1612-12-13 | 10¼Wx10Dx7½H

ITEM 1612-12-55 | 10¼Wx10Dx7½H

ITEM 1612-22-13 | 19¾Wx10Dx7½H

ITEM 1612-22-55 | 19¾Wx10Dx7½H



## D. LUXE CHAFER ALTERNATIVES

Stainless Steel (55).

ITEM 3407-55 | 10¼Wx10Dx8¼H

ITEM 3391-55 | 19¾Wx10Dx9½H



## E. ONE BY ONE CHAFER ALTERNATIVES

ITEM 1348-12-13 | 10¼Wx10Dx4H

ITEM 1409-12-13 | 10¼Wx10Dx7H

ITEM 1348-22-13 | 19¾Wx10Dx4H

ITEM 1409-22-13 | 19¾Wx10Dx7H



## F. MISSION CHAFER ALTERNATIVES

Griddle Sold Separately

Works Only with 1360-22-13 and 1364-22-13).

ITEM 1360-12-13 | 10¼Wx10Dx7½H

ITEM 1360-22-13 | 19¾Wx10Dx7½H

ITEM 1364-12-13 | 10¼Wx10Dx5H

ITEM 1364-22-13 | 19¾Wx10Dx4H

ITEM 1362 | Optional Griddle

Please visit [www.calmil.com/legal](http://www.calmil.com/legal) for a complete list of California Proposition 65 related items.



**G. MID-CENTURY BUTANE STOVE FRAME**

Butane Stove Sold Separately.  
Specify Color: Brass (46), Chrome (49).

ITEM 3712 | 14¼Wx12¼Dx7¼H

ITEM 4010-I | Optional Butane Stove



**H. URBAN BUTANE STOVE FRAME**

Butane Stove Sold Separately.  
Stainless Steel (55).

ITEM 3390-55 | 14Wx12½Dx7¼H

ITEM 4010-I | Optional Butane Stove



**K. MONTEREY BUTANE STOVE FRAME **NEW****

Butane Stove Sold Separately.

ITEM 22115-15 | 14Wx12¼Dx7¼H

ITEM 4010-I | Optional Butane Stove



**I. LUXE BUTANE STOVE FRAME**

Butane Stove Sold Separately.  
Stainless Steel Trim (55).

ITEM 3023-55 | 12Wx14¼Dx7½H

ITEM 4010-I | Optional Butane Stove



**J. SOHO BUTANE STOVE FRAME**

Butane Stove Sold Separately.  
Specify Color: Black (13), Silver (74).

ITEM 1576 | 14Wx13¼Dx7¼H

ITEM 4010-I | Optional Butane Stove

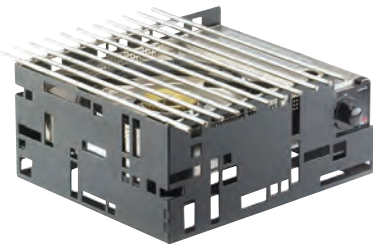

**L. SQUARED BUTANE STOVE FRAME**

Butane Stove Sold Separately.

ITEM 1617-13 | 13Wx11Dx6H - Black

ITEM 1617-55 | 13Wx11Dx6H - Stainless Steel

ITEM 4010-I | Optional Butane Stove



**M. MADERA BUTANE STOVE FRAME**

Butane Stove Sold Separately.

ITEM 3435-99 | 12¾Wx14¼Dx6½H

ITEM 4010-I | Optional Butane Stove



**N. MISSION BUTANE STOVE FRAME**

Butane Stove Sold Separately.

ITEM 1363-13 | 14Wx12Dx7H

ITEM 4010-I | Optional Butane Stove



**O. GRIDDLE OPTIONS**

ITEM 1362 | 22¾Wx13¾Dx2¼H | w/Brackets

ITEM 3067 | 22¾Wx13¾Dx2¼H | w/Heat Guard Handles

**P. ROUND CHAFER ALTERNATIVE/GRILL **NEW****

Includes Wire Grill and Skillet.

ITEM 22031-13 | 16¾DIAx7½H



Please visit [www.calmil.com/legal](http://www.calmil.com/legal) for a complete list of California Proposition 65 related items.



# chafers & alternatives



**A. EMPIRE BUTANE STOVE FRAME NEW**

ITEM 22089-90 | 14¼Wx13Dx7¼H



**B. PORTLAND BUTANE STOVE FRAME**

Optional Butane Stove Sold Separately.

ITEM 4109-13 | 13Wx14Dx7½H | Black



**C. PORTLAND BUTANE STOVE FRAME**

Optional Butane Stove Sold Separately.

ITEM 4109-15 | 13Wx14Dx7½H | White NEW



**D. GRANADA BUTANE STOVE FRAME**

Optional Butane Stove Sold Separately.

4028-85 | 13Wx14½Dx7½H

4010-I | Optional Butane Stove



**E. CINDERWOOD BUTANE STOVE FRAME**

Optional Butane Stove Sold Separately.

ITEM 3816-87 | 12Wx14Dx7½H

ITEM 4010-I | Optional Butane Stove



**F. ASHWOOD BUTANE STOVE FRAME**

Optional Butane Stove Sold Separately.

ITEM 3816-83 | 12Wx14Dx7½H

ITEM 4010-I | Optional Butane Stove



**G. BAMBOO BUTANE STOVE FRAME**

Optional Butane Stove Sold Separately.

ITEM 3435-60 | 14½Wx13Dx7½H

ITEM 4010-I | Optional Butane Stove



**H. WESTPORT BUTANE STOVE FRAME**

Optional Butane Stove Sold Separately.

ITEM 1556-52 | 14Wx14½Dx7½H

ITEM 4010-I | Optional Butane Stove



**I. IWATANI BUTANE STOVE**

ITEM 4010-I | Optional Butane Stove

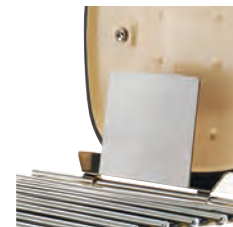

**J. LID HOLDER ATTACHMENT NEW**

Fits Alternative Chafer Grills.

ITEM 22045 | 1¾Wx6Dx4½H

Please visit [www.calmil.com/legal](http://www.calmil.com/legal) for a complete list of California Proposition 65 related items.

## 9 Induction Frames To Choose From!



3633-60

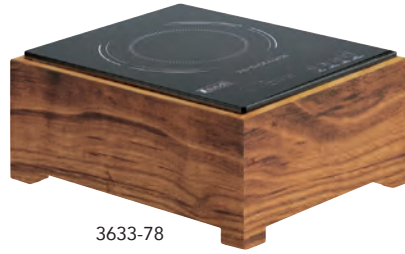

3633-78



3633-83



3633-87



3633-99



4026-85



4100-13



4100-15



22114-15

### K. INDUCTION UNITS

Includes Induction Burner.

ITEM 3633-60 | 12¾Wx16Dx7¼H | Bamboo

ITEM 3633-78 | 12¾Wx16Dx7¼H | Walnut

ITEM 3633-83 | 12¾Wx16Dx7¼H | Ashwood

ITEM 3633-87 | 15½Wx12½Dx7H | Cinderwood

ITEM 3633-99 | 12¾Wx16Dx7¼H | Madera

ITEM 4026-85 | 12¾Wx16Dx7¾H | Granada

ITEM 4100-13 | 12¾Wx15½Dx7H | Black Portland

ITEM 4100-15 | 12¾Wx15½Dx7H | White Portland **NEW**

ITEM 22114-15 | 12¾Wx15¾Dx7¼H | Monterey **NEW**



### L. MISSION INDUCTION FRAME

Induction Unit Not Included.

1414-S Fits Spring SR-261C.

1414-V Fits Volrath 59500.

ITEM 1414-S-13 | 13¾WX16½DX7H

ITEM 1414-V-13 | 14¾WX16½DX7H

Please visit [www.calmil.com/legal](http://www.calmil.com/legal) for a complete list of California Proposition 65 related items.

CAL•MIL | visit us online at: [www.calmil.com](http://www.calmil.com) | call toll-free 800-321-9069



# salad displays & sneezeguards



B

## B. CLEAR SALAD BAR ICE HOUSING

Housing Only — PETG Body.  
1398-12 Model Comes with Drain Kit.  
Salad Bar Accessories Sold Separately.

ITEM 1398-12 | 24Wx32Dx4¼H

ITEM 1399-12 | 16Wx24Dx4¼H



## A. STAINLESS STEEL SALAD BAR ICE HOUSING

Salad Bar Accessories Sold Separately.

ITEM 1398-55 | 24Wx32Dx4¼H

ITEM 1399-55 | 16Wx24Dx4¼H



C

## C. CLASSIC CONDIMENT STATION

Includes 4 - 1/6 Pans and Notched Lids.

ITEM 3687-13 | 13¾Wx16¼Dx9H

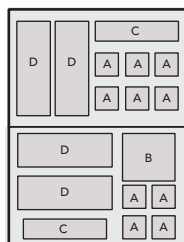

Large Rectangle Variations (Unlimited)

## D. CHILLED SALSA/DRESSING SERVER

Fill Bottom of Bin with Ice and Serve.  
Includes 4 White Crocks.

ITEM 3369-13 | 10½Wx10½Dx7H



D

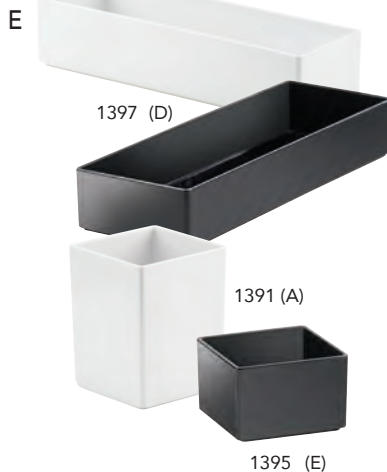

1397 (D)

1391 (A)

1395 (E)

## E. SALAD BAR ACCESSORIES

Trays for Ice Housings for the Ultimate Salad Bar.

Specify Color: Clear (12),  
Black Melamine (13M),  
White Melamine (15M).

ITEM 1391 (A) | 5Wx5Dx6H

ITEM 1393 (B) | 10Wx10Dx3H

ITEM 1395 (E) | 5Wx5Dx3H

ITEM 1396 (C) | 5Wx15Dx3H

ITEM 1397 (D) | 7Wx20Dx3H

Please visit [www.calmil.com/legal](http://www.calmil.com/legal) for a complete list of California Proposition 65 related items.

**F. SALAD DRESSING CADDY**

Complete Set Includes:  
 1 Rack, 4 Bottles, 4 Each of Each Lid  
 Except Dripless, and 4 Blank Sign Clips.  
 Dimensions: 13Wx10.75Dx5H.  
 Ice Housings Sold Separately,  
 (See Pages 210-219).

ITEM 3300-RACK | Caddy Rack Only

ITEM 3300-SET | Complete Caddy & Bottle Set



Photo Shows 2ea:  
 3300-RACK With  
 Optional Ice Housing

**G. SET OF SALAD DRESSING CLIPS**

Set Includes 1 Each of Blue Cheese, House,  
 Thousand Island, Italian, Ranch, French,  
 and Balsamic.  
 2 Each of Blank Clips.

ITEM 3300-CLIPSET | Set of 9

ITEM 3300-28CLIP | Blank Sign Clip



**H. BOTTLES, LIDS,  
 & ACCESSORIES**

ITEM 3300-28 | 28 oz. Bottle

ITEM 3300-28NODRIP | Dripless Pour Lid

ITEM 3300-28LIDLG | Large Pour Lid

ITEM 3300-28LIDSM | Small Pour Lid

ITEM 3300-28JP | Juice Pour Lid

ITEM 3300-28SL | Storage Lid

ITEM 3300-28CAP | Stopper Cap for 3300-28JP



Please visit [www.calmil.com/legal](http://www.calmil.com/legal) for a complete list of California Proposition 65 related items.



# salad displays & sneezeguards



**A. MADERA SALAD STATION**  
Includes Liner and 5 Pan Inserts.

ITEM 3585-99 | 21½Wx12½Dx6H



**B. GRANADA SNEEZEGUARD STATION**  
Includes Base, Tiles, and Sneezeguard.

ITEM 4000-86 | 27¼Wx18¾Dx19¼H

ITEM 4000-86TILE | 13½Wx18Dx½H



White and Black  
Round Jars

Round  
Write On

## C. MELAMINE ROUND JARS

Write-On is Commercial Grade, Scratch and Dent Proof!

### WHITE AND BLACK

Specify Color: Black (13), White (15).

ITEM 1950-16 | 4DIAx4¼H - 16 oz.

ITEM 1950-32 | 5DIAx5½H - 32 oz.

ITEM 1950-64 | 6¾DIAx6¼H - 64 oz.

ITEM 1950-32-13NL | Black 32 oz Jar Notched Lid

ITEM 1950-32-15NL | White 32 oz Jar Notched Lid

### WRITE-ON

ITEM 1950-16-15C | 4DIAx4¼H - 16 oz.

ITEM 1950-32-15C | 5DIAx5½H - 32 oz.

ITEM 1950-64-15C | 6¾DIAx6¼H - 64 oz.

ITEM 3062-15 | White Chalkboard Pen



## E. STAINLESS STEEL GEL-FILLED COLD BOWLS ❄️

Keep Gel-Filled Bowl in Freezer for Minimum of 6 Hours to Keep Contents Cold for Hours!

ITEM 3326-7-55 | 7Wx7Dx4H

ITEM 3326-10-55 | 10Wx10Dx4H



Square  
White Only

Square  
Write On

## D. MELAMINE SQUARE JARS

Write-On is Commercial Grade, Scratch and Dent Proof!

### WHITE ONLY

ITEM C1432BODY | 4Wx4Dx4H | Jar Only

ITEM 1432-15 | 4Wx4Dx4H | w/ Full Lid

ITEM 1432-15N | 4Wx4Dx4H | w/ Notched Lid

### WRITE-ON

ITEM C1432BODYC | 4Wx4Dx4H | Jar Only

ITEM 1432-15C | 4Wx4Dx4H | w/ Full Lid

ITEM 1432-15N-C | 4Wx4Dx4H | w/ Notched Lid

ITEM 3062-15 | White Chalkboard Pen



Notched

## F. LIDS FOR ROUND MELAMINE JARS

ITEM 1950-16LID | Fits 16 oz. Jar

ITEM 1950-16LIDN | Fits 16 oz. Jar | Notched

ITEM 1950-32LID | Fits 32 oz Jar

ITEM 1950-32LIDN | Fits 32 oz. Jar | Notched

ITEM 1950-64LID | Fits 64 oz. Jar

ITEM 1950-64LIDN | Fits 64 oz. Jar | Notched

Please visit [www.calmil.com/legal](http://www.calmil.com/legal) for a complete list of California Proposition 65 related items.



**G. TWO-TIER MERCHANDISER SALAD DISPLAY**

ITEM 2028-3-55 | 31½Wx17Dx25¾H

ITEM 2028-4-55 | 49½Wx17Dx25¾H



**H. TABLE MOUNT BUFFET GUARD – DOUBLE FACE**

Specify Frame Color: Black (13), Silver (74).

ITEM 2027-36 | 37¼Wx27¼Dx21½H

ITEM 2027-4 | 49¼Wx27¼Dx21½H

ITEM 2027-6 | 73¼Wx27¼Dx21½H



**I. STAINLESS STEEL SNEEZEGUARDS**

ITEM 2026-36-55 | 37¼Wx16Dx20¾H

ITEM 2026-4-55 | 49¼Wx16Dx20¾H

ITEM 2026-6-55 | 73¼Wx16Dx20¾H



**J. PORTABLE METAL FRAME SNEEZEGUARD**

Adjustable Height From 14" to 20".  
Sneeze guard Angle Also Adjustable.

ITEM 751-3 | 30Wx18Dx20H

ITEM 751-4 | 48Wx18Dx20H

ITEM 751-6 | 72Wx18Dx20H



**K. PORTABLE WIRE SNEEZEGUARD & OPTIONAL FOOD STATION**

Sneeze guard & Food Station Sold Separately.

ITEM 1018 | 30½Wx21Dx15H | Sneeze guard

OPTIONAL FOOD STATION & BOWLS

ITEM 728-13 | 18Wx26Dx4H | Food Station With Step & Fluted Bowls

ITEM 407-8-13 | Replacement Step Bowl

ITEM 453-13 | Replacement Fluted Bowl

Please visit [www.calmil.com/legal](http://www.calmil.com/legal) for a complete list of California Proposition 65 related items.



# salad displays & sneezeguards



## A. CLASSIC SALSA/CONDIMENT BAR

Complete Set w/Pans as Shown.

ITEM 1102 | 20½Wx12¾Dx19¾H

## B. CLASSIC SALSA/CONDIMENT BAR

Complete Set w/Pans as Shown.

ITEM 658 | 14Wx15Dx20H

## C. MELAMINE STONEWARE SERVINGWARE

ITEM 3471-5 | 5½DIAx4H

ITEM 3471-9 | 9DIAx3H

ITEM 3471-12 | 12Wx9Dx3¼H

## D. GLACIER PORTABLE BUFFET SNEEZEGUARDS

ITEM 710-4 | 48Wx12½Dx18H

ITEM 710-6 | 72Wx12½Dx18H

ITEM 768 | 29½Wx12Dx26H

## E. PORTABLE ATTENDANT SERVE SNEEZEGUARD

ITEM 3478-3-39 | 30Wx9Dx18H

ITEM 3478-4-39 | 48Wx9Dx18H

## F. SINGLE-FACE SNEEZEGUARD CARRIER

For a List of Compatible Sneezeguards Please Visit [www.calmil.com](http://www.calmil.com).

ITEM 3615-3 | 38½Wx19½Dx3½H

ITEM 3615-6 | 75Wx19½Dx3½H

Please visit [www.calmil.com/legal](http://www.calmil.com/legal) for a complete list of California Proposition 65 related items.



**G. SUSPENDED SNEEZEGUARD  
– DOUBLE FACE**

Includes Chain and Mounting Hardware.  
Truck Shipment Only.  
Custom Length Upon Request.

ITEM 774-S | 72Wx30Dx6H

**H. IRON SMALL RECTANGLE GUARD  
– SINGLE FACE**

Includes 2 Wire Legs and Guard.

ITEM 1456 | 27½Wx13Dx14H

**I. SUSPENDED SNEEZEGUARD  
– SINGLE FACE**

Includes Chain and Mounting Hardware.  
UPS Shipable. Custom Lengths Upon Request.

ITEM 776-S | 48Wx18Dx2H

ITEM 778-S | 72Wx18Dx2H

**J. IRON LARGE RECTANGLE GUARD  
– SINGLE FACE**

Includes 2 Wire Legs and Guard.

ITEM 1458-30 | 30Wx17¼Dx19H

ITEM 1458-48 | 48Wx17¼Dx19H

ITEM 1458-72 | 72Wx17¼Dx19H

Please visit [www.calmil.com/legal](http://www.calmil.com/legal) for a complete list of California Proposition 65 related items.



# ice housings



Your Custom Design Insert

## A. GRANADA ICE HOUSINGS

Includes Clear Polycarbonate Pan.

ITEM 4018-6-85 | 7Wx7½Dx6¾H

ITEM 4018-10-85 | 13¼Wx11Dx6¾H

ITEM 4018-12-85 | 21¼Wx13½Dx6¾H



## B. MONTEREY ICE HOUSINGS **NEW**

Includes White Melamine Ice Pan.

ITEM 22020-6-13 | 6½Wx7Dx8H

ITEM 22020-10-13 | 12¼Wx9½Dx8½H

ITEM 22020-12-13 | 20¼Wx12¼Dx9¼H



## C. STAINLESS STEEL ICE HOUSINGS **NEW**

Includes Clear Polycarbonate Pan.

ITEM 22064-6-55 | 6¼Wx5½Dx6H

ITEM 22064-10-55 | 12¼Wx10Dx6H

ITEM 22064-12-55 | 20Wx21Dx6H

Please visit [www.calmil.com/legal](http://www.calmil.com/legal) for a complete list of California Proposition 65 related items.



D

**D. BAMBOO ICE HOUSING**

Includes Clear Polycarbonate Pan.

ITEM 475-6-60 | 6Wx7Dx6½H

ITEM 475-10-60 | 10Wx12Dx6½H

ITEM 475-12-60 | 20Wx12Dx6½H



E

**E. PORTLAND ICE HOUSINGS**

Includes Clear Polycarbonate Pan.

Specify Color: Black (13), White (15) **NEW**

ITEM 41115-6 | 6½Wx7Dx8¾H

ITEM 41115-10 | 13Wx13¼Dx8¾H

ITEM 41115-12 | 21Wx13¼Dx8¾H



F

**F. EMPIRE ICE HOUSINGS **NEW****

Includes Clear Polycarbonate Pan.

ITEM 22085-10-90 | 13¾Wx11Dx6¾H

ITEM 22085-12-90 | 22Wx13½Dx6¾H



G

**G. SIERRA ICE HOUSINGS**

Includes Clear Polycarbonate Pan.

ITEM 3905-10-84 | 13¾Wx11¼Dx6H

ITEM 3905-12-84 | 21¾Wx13¾Dx6H

**H. MADERA ICE HOUSINGS**

Includes Clear Polycarbonate Pan.

ITEM 3360-6 | 7¾Wx7Dx7H

ITEM 3360-10 | 13Wx11Dx6½H

ITEM 3360-12 | 21½Wx12½Dx6H



H

Please visit [www.calmil.com/legal](http://www.calmil.com/legal) for a complete list of California Proposition 65 related items.



# ice housings



## A. ASHWOOD ICE HOUSINGS

Includes Clear Polycarbonate Pan.

ITEM 3800-6-83 | 7½Wx7½Dx7H

ITEM 3800-10-83 | 13¼Wx11Dx7¼H

ITEM 3800-12-83 | 21¼Wx13¼Dx7H



## B. CINDERWOOD ICE HOUSINGS

Includes Clear Polycarbonate Pan.

ITEM 3800-6-87 | 7½Wx7½Dx7H

ITEM 3800-10-87 | 13¼Wx11Dx7¼H

ITEM 3800-12-87 | 21¼Wx13¼Dx7H



## C. MISSION ICE HOUSINGS

Includes Clear Polycarbonate Pan.

ITEM 1365-12-13 | 22Wx14Dx8½H

ITEM 1365-18-13 | 28Wx20Dx8½H



## D. LUXE ICE HOUSING

Includes Clear Polycarbonate Bin.  
Stainless Steel Trim (55).

ITEM 3005-10-55 | 12¼Wx10Dx6½H

ITEM 3005-12-55 | 20¼Wx12¼Dx6¼H



## E. SQUARED ICE HOUSING

Includes Clear Polycarbonate Pan.  
Black (13), Stainless Steel (55).

ITEM 1603-12-13 | 21Wx12½Dx6½H

ITEM 1603-12-55 | 21Wx12½Dx6½H



## F. WESTPORT ICE HOUSING

Includes Clear Polycarbonate Pan.

ITEM 412-12-52 | 20Wx12Dx8H

ITEM 412-18-52 | 26Wx18Dx8H

Please visit [www.calmil.com/legal](http://www.calmil.com/legal) for a complete list of California Proposition 65 related items.

**G. MID-CENTURY ICE HOUSINGS**

Includes Clear Polycarbonate Pan.  
Specify Color: Brass (46), Chrome (49).

ITEM 3702-6 | 7¾Wx7Dx7¼H

ITEM 3702-10 | 13¾Wx11¼Dx7¼H

ITEM 3702-12 | 21¾Wx13½Dx7¼H



**H. CLASSIC MELAMINE ICE HOUSINGS**

Includes Clear Polycarbonate Pan.  
Specify Color: Black (13), White (15).

ITEM 475-6 | 6Wx7Dx7H

ITEM 475-10 | 12Wx10Dx7H

ITEM 475-12 | 20Wx12Dx7H



**I. MIDNIGHT BAMBOO ICE HOUSINGS**

Includes Clear Polycarbonate Pan.

ITEM 475-6-96 | 6Wx7Dx6½H

ITEM 475-10-96 | 12Wx10Dx6½H

ITEM 475-12-96 | 20Wx12Dx6½H



**J. ACRYLIC ICE HOUSING**

Includes Clear Polycarbonate Pan.  
Black (17).

ITEM 368-12-17 | 20Wx12Dx6H



**K. URBAN STAINLESS STEEL ICE HOUSINGS**

Includes Clear Polycarbonate Pan.

ITEM 3395-10-55 | 12¾Wx10¼Dx6¾H

ITEM 3395-12-55 | 20¾Wx12¾Dx7¼H



Please visit [www.calmil.com/legal](http://www.calmil.com/legal) for a complete list of California Proposition 65 related items.



# ice housings

A



## A. CHALKBOARD ICE HOUSINGS

Includes Clear Polycarbonate Pan.  
Can also be used as crates!

ITEM 3354-6 | 7Wx7Dx8H

ITEM 3354-10 | 13Wx11Dx7H

ITEM 3354-12 | 21½Wx13½Dx7H

ITEM 3062-15 | White Chalkboard Pen

B



## B. STAINLESS STEEL & COPPER HOUSING

Includes Clear Polycarbonate Pan (Not Pictured).  
Specify Color: Copper (51),  
Stainless Steel (55).

ITEM 475-6 | 6Wx7Dx6½H

ITEM 475-10 | 12Wx10Dx6½H

ITEM 475-12 | 20Wx12Dx6½H

C



## C. SOHO ICE HOUSING

Includes Clear Polycarbonate Pan.  
Frost (33).

ITEM 1582-12-33 | 21Wx12Dx8¼H | Silver

## D. FOLDING ICE HOUSINGS

Insert Pans Sold Separately. Black (13).

ITEM BH4220-13 | 20Wx12Dx6H

ITEM BH4618-13 | 26Wx18Dx6H

### OPTIONAL CLEAR INSERT PANS

ITEM 477-12CL | 20Wx12Dx6H

ITEM 477-18 | 26Wx18Dx6H

D



## E. FULLY INSULATED HOUSINGS

Available Only in Black.

ITEM 463-12-13 | 20Wx12Dx6H

ITEM 463-18-13 | 26Wx18Dx6H

E



Please visit [www.calmil.com/legal](http://www.calmil.com/legal) for a complete list of California Proposition 65 related items.



**F. INSULATED ICE HOUSING**

ITEM 1256-13 | 20Wx15Dx6½H



**G. POLYCARBONATE ICE BUCKET NEW**

ITEM 22056 | 12¼DIAx8¼H

**H. CARAFE AND CARAFE COLLAR**  
Ice Housing Not Included.

ITEM 438 | 1 Liter Carafe

ITEM 707-12 | 20Wx12Dx1H | Carafe Collar



**I. TWO TIER HOUSING DISPLAYS**

All Pieces Sold Separately.

ITEM 4120 | 26¼Wx26Dx14¼H | Angled Frame

ITEM 4120-B | 24Wx16Dx16H | Two-Tier Frame

ITEM 4120-TRAY | 24Wx16Dx4½H | Insulated Tray



4120 Frame with Two 4120-TRAYS

4120-B Frame with Two 4120-TRAYS

4120-TRAY



# ice housings



IP402

## A. 2 TIER METAL ICE HOUSING

Includes Stand, PETG Ice Pan, Drainage Hose, and Basic LED Lighting. Ships by Truck Only. Specify Color: Black (13), Platinum (39).

ITEM IP402 | 24Wx48Dx12.5H

### OPTIONAL LED UNIT

Over 20 Speeds and Color Patterns. Use 1 for Small Ice Displays, and 2 For Large Ice Displays.

ITEM LED100 | LED Light Pack



B

## B. LARGE ULTIMATE ICE HOUSING SYSTEM

Includes PETG Ice Pan, Water Containment Unit, and Basic LED Lighting. Specify Color: Black (13), Platinum (39).

ITEM IP1020 | 19Wx27Dx10H

ITEM IP2020\* | 24Wx48Dx10H

\*Ships by Truck Only

### OPTIONAL LED UNIT

Over 20 Speeds and Color Patterns. Use 1 for Small Ice Displays, and 2 For Large Ice Displays.

ITEM LED100 | LED Light Pack



Water Containment Units Available in Large or Small.

### OPTIONAL WATER CONTAINMENT UNIT

Collects and Stores Melted Ice Water for Hours. Designed to Fit Ultimate Ice Housing Systems Only.

ITEM WU100 | 13Wx22Dx3H | Small

ITEM WU200 | 17Wx42Dx3H | Large



C

3326-7-55

## C. STAINLESS STEEL ICE PEDESTALS

Includes Stand, PETG Ice Pan, Drainage Hose, and Basic LED Lighting.

ITEM 3033-55 | 28½Wx20½Dx8½H

ITEM 3326-7-55 | 7Wx7Dx4H | Stainless Cold Bowl

Please visit [www.calmil.com/legal](http://www.calmil.com/legal) for a complete list of California Proposition 65 related items.



**D. ORIGINAL LARGE  
ICE CARVING PEDESTAL**  
Includes Stand, PETG Ice Pan, Drainage  
Hose, and Basic LED Lighting.  
Ships by Truck Only.  
Specify Color: Black (13), Platinum (39).

ITEM IP202 | 24Wx48Dx8H

**OPTIONAL LED UNIT**  
Over 20 Speeds and Color Patterns.  
Use 1 for Small Ice Displays,  
and 2 For Large Ice Displays.

ITEM LED100 | LED Light Pack



**E. SMALL METAL  
ICE CARVING PEDESTAL**  
Includes Stand, PETG Ice Pan, Drainage  
Hose, and Basic LED Lighting.  
Specify Color: Black (13), Platinum (39).

ITEM IP102 | 28½Wx20½Dx10H

**F. OPTIONAL LED UNIT**  
Over 20 Speeds and Color Patterns.  
Use 1 for Small Ice Displays,  
and 2 For Large Ice Displays.

ITEM LED100 | LED Light Pack



LED Light Pack

**G. EXTRA RECTANGULAR ICE PANS**

ITEM IP152 | 28Wx20Dx4H

ITEM IP252\* | 24Wx48Dx4H

\*Ships by Truck Only





# ice housings



A

- RECESSED ACRYLIC MIRROR PANELS PROVIDE MAXIMUM PROTECTION.
- BUILT-IN LED LIGHTING WITH EASILY ADJUSTABLE MULTIPLE LIGHT PATTERN SELECTIONS.
- DURABLE AND CHIP RESISTANT COMMERCIAL GRADE PETG PANS.
- CONVENIENT SELF-DRAIN DESIGN.
- QUALITY CONSTRUCTION PROVIDES SUPPORT UP TO 500 LBS.



B



## A. MIRROR ICE CARVING PEDESTALS WITH LED PEDESTAL

Includes PETG Ice Pan, Drainage Hose, and Built in LED Lighting with Multiple Light Pattern Selections.

Available Only in Mirror With 110 or 220 Volt.

### SMALL

ITEM IP101-110 | 19Wx27Dx10H | 110 Volts

ITEM IP101-220 | 19Wx27Dx10H | 220 Volts

### LARGE

ITEM IP201-110\* | 24Wx48Dx14H | 110 Volts

ITEM IP201-220\* | 24Wx48Dx14H | 220 Volts

\*Ships by Truck Only

## B. ROTATING ICE CARVING MIRROR PEDESTAL

Includes PETG Ice Pan, Drainage Hose, and Built in LED Lighting with Multiple Light Pattern Selections. Available Only in Mirror With 110 or 220 Volt.

ITEM IP501-110 | 24DIAx14H | 110 Volts

ITEM IP501-220 | 24DIAx14H | 220 Volts

Please visit [www.calmil.com/legal](http://www.calmil.com/legal) for a complete list of California Proposition 65 related items.



C

**C. LARGE RECTANGLE CLEAR ICE TRAYS WITH SOLID BASES**

Includes Stand, PETG Ice Pan, Drainage Hose, and Basic LED Lighting.  
Ships by Truck Only.

ITEM 987-12 | 48Wx24Dx5½H

**OPTIONAL LED UNIT**

Over 20 Speeds and Color Patterns.  
Use 1 for Small Ice Displays and 2 For Large Ice Displays.

ITEM LED100 | LED Light Pack



D

**D. SMALL RECTANGLE CLEAR ICE TRAYS WITH SOLID BASES**

Includes Stand, PETG Ice Pan, Drainage Hose, and Basic LED Lighting.  
Ships by Truck Only.

ITEM 986-12 | 28½Wx20½Dx5½H

**E. OPTIONAL LED UNIT**

Over 20 Speeds and Color Patterns.  
Use 1 for Small Ice Displays and 2 For Large Ice Displays.

ITEM LED100 | LED Light Pack



E

LED Light Pack

**F. EXTRA RECTANGULAR ICE PANS**

ITEM IP152 | 28Wx20Dx4H

ITEM IP252\* | 24Wx48Dx4H

\*Ships by Truck Only



F





# ice scoops & holders



A



B

## A. POLYCARBONATE WALL MOUNT SCOOP HOLDERS

Hardware Not Included for Wall Mount.

ITEM 790 | 4½Wx4Dx10H | 6 oz.

ITEM 356 | 6Wx5¼Dx11½H | 32 oz.

ITEM 793 | 7½Wx7Dx13H | 64 oz.

## B. POLYCARBONATE ICE SCOOPS

ITEM 1029-3S | 2¾Wx1¾Dx8¼H | 3oz. Short Handle

ITEM 1029-6 | 3¼Wx2¼Dx10¼H | 6 oz.

ITEM 1029-32 | 4¾Wx3½Dx11H | 32 oz.

ITEM 1029-64 | 6Wx4½Dx14¼H | 64 oz.

Please visit [www.calmil.com/legal](http://www.calmil.com/legal) for a complete list of California Proposition 65 related items.

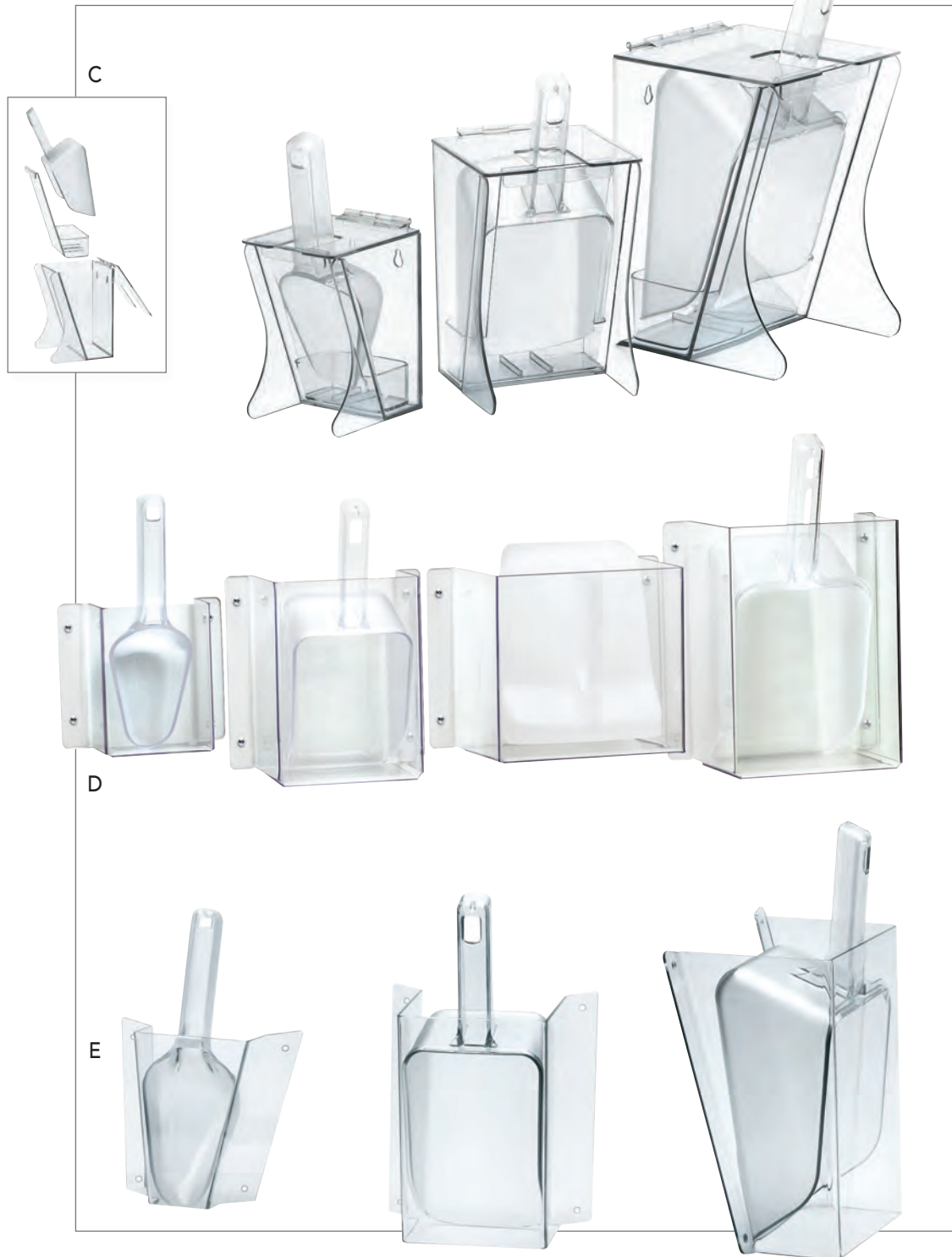

**C. POLYCARBONATE  
FREESTANDING SCOOP HOLDERS**  
Hardware Not Included for Wall Mount.

- ITEM 789 | 4½Wx4Dx10H | 6 oz.
- ITEM 355 | 6Wx5¼Dx11½H | 32 oz.
- ITEM 792 | 7½Wx7Dx13H | 64 oz.

**D. SCOOP GUARDS**  
Wall Mount Includes Scoop.  
Hardware Not Included.

- ITEM 623 | 3Wx6Dx10¼H | 6 oz.
- ITEM 624 | 4¼Wx8Dx11¾H | 32 oz.
- ITEM 631 | 7¼Wx5Dx9¾H | 64 oz.
- ITEM 638 | 9Wx9Dx8H | 64 oz.

**E. ANGLED SCOOP GUARDS**  
Wall Mount Includes Scoop.  
Hardware Not Included.

- ITEM 1031-6 | 3Wx6Dx10¼H | 6 oz.
- ITEM 1031-32 | 4¼Wx7½Dx11¾H | 32 oz.
- ITEM 1031-64 | 5Wx8½Dx13¾H | 64 oz.

Please visit [www.calmil.com/legal](http://www.calmil.com/legal) for a complete list of California Proposition 65 related items.



# riser displays



## A. MADERA ROUND RISERS **NEW**

ITEM 22050-3-99 | 12DIAx3H

ITEM 22050-6-99 | 12DIAx6H

ITEM 22050-9-99 | 12DIAx9H

## B. ASHWOOD HEXAGON RISERS

ITEM 435-5-83 | 12DIAx5H

ITEM 435-8-83 | 12DIAx8H

ITEM 435-11-83 | 12DIAx11H

## C. CINDERWOOD HEXAGON RISERS

ITEM 435-5-87 | 12DIAx5H

ITEM 435-8-87 | 12DIAx8H

ITEM 435-11-87 | 12DIAx11H

## D. MID-CENTURY SQUARE RISERS

ITEM 432-3-78 | 12Wx12Dx3¼H

ITEM 432-6-78 | 12Wx12Dx6¼H

ITEM 432-9-78 | 12Wx12Dx9H

## E. MADERA HEXAGON RISERS

ITEM 435-5-99 | 12DIAx5H

ITEM 435-8-99 | 12DIAx8H

ITEM 435-11-99 | 12DIAx11H

Please visit [www.calmil.com/legal](http://www.calmil.com/legal) for a complete list of California Proposition 65 related items.



**F. BAMBOO CUBE & RECTANGLE RISERS**

- ITEM 166-3-60 | 20Wx7Dx3H
- ITEM 166-7-60 | 20Wx7Dx7H
- ITEM 166-11-60 | 20Wx7Dx11H
- ITEM 432-3-60 | 12Wx12Dx3H
- ITEM 432-6-60 | 12Wx12Dx6H
- ITEM 432-9-60 | 12Wx12Dx9H

**H. STAIR STEP RISERS**

Specify Color: Bamboo (60), Midnight Bamboo (96).

- ITEM 1934-4 | 20Wx10Dx4H
- ITEM 1934-8 | 22Wx10Dx8H
- ITEM 1934-12 | 24Wx10Dx12H

**G. MIDNIGHT BAMBOO CUBE & RECTANGLE RISERS**

- ITEM 166-3-96 | 20Wx7Dx3H
- ITEM 166-7-96 | 20Wx7Dx7H
- ITEM 166-11-96 | 20Wx7Dx11H
- ITEM 432-3-96 | 12Wx12Dx3H
- ITEM 432-6-96 | 12Wx12Dx6H
- ITEM 432-9-96 | 12Wx12Dx9H

**I. WESTPORT/MIDNIGHT BAMBOO CUBE RISER SET**

Sizes: 9" Square, 7" Square, and 5" Square.

- ITEM 1915 | Westport Set
- ITEM 1915-96 | Midnight Bamboo Set

Please visit [www.calmil.com/legal](http://www.calmil.com/legal) for a complete list of California Proposition 65 related items.



# riser displays



**A. WALNUT**  
**RECTANGULAR RISERS**  
Walnut (78).

ITEM 166-3-78 | 20Wx7Dx3H

ITEM 166-7-78 | 20Wx7Dx7H

ITEM 166-11-78 | 20Wx7Dx11H



**B. ASHWOOD**  
**RECTANGULAR RISERS**

ITEM 166-3-83 | 20Wx7Dx3H

ITEM 166-7-83 | 20Wx7Dx7H

ITEM 166-11-83 | 20Wx7Dx11H



**C. LUXE**  
**RECTANGULAR RISERS**  
Stainless Steel Trim (55).

ITEM 3026-55 | 12Wx10Dx6½H

ITEM 3025-55 | 12Wx20Dx6½H



**D. MID-CENTURY**  
**REVERSIBLE RISER**  
Specify Color:  
Brass (46), Chrome (49).

ITEM 3724 | 20Wx7Dx6H

Please visit [www.calmil.com/legal](http://www.calmil.com/legal) for a complete list of California Proposition 65 related items.

**E. RECTANGULAR CRATE RISERS**

These Risers Can Also be Used as Bins and Work with Our Bamboo Shelves. Specify Color: Bamboo (60), Midnight Bamboo (96).

ITEM 1943-3 | 20Wx7Dx3H

ITEM 1943-7 | 20Wx7Dx7H

ITEM 1943-11 | 20Wx7Dx11H



**F. SQUARE CRATE RISERS**

These Risers Can Also be Used as Bins and Work with Our Bamboo Shelves. Specify Color: Bamboo (60), Midnight Bamboo (96). See Pages 84 and 104 For Shelves.

ITEM 1944-6 | 6Wx6Dx6H

ITEM 1944-9 | 9Wx9Dx9H

ITEM 1944-12 | 12Wx12Dx12H

ITEM 3332-4 | 12Wx12Dx4H

ITEM 3332-7 | 12Wx12Dx7H

ITEM 3332-10 | 12Wx12Dx10H



**G. MADERA RECTANGULAR RISERS**

ITEM 166-3-99 | 20½Wx7Dx3¼H

ITEM 166-7-99 | 20½Wx7Dx7H

ITEM 166-11-99 | 20½Wx7Dx11H



**H. MADERA CUBE RISERS**

ITEM 432-3-99 | 12Wx12Dx3¼H

ITEM 432-6-99 | 12Wx12Dx6H

ITEM 432-9-99 | 12Wx12Dx9H





# riser displays

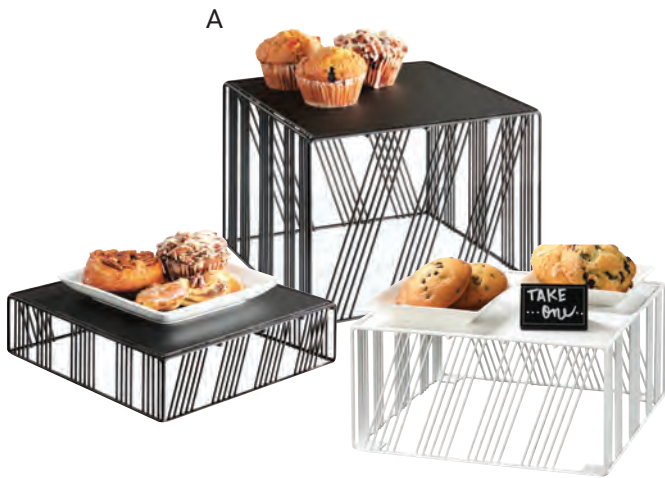

## A. PORTLAND SQUARE RISERS

Specify Color: Black (13), White (15) **NEW**

ITEM 432-3 | 12Wx12Dx3H

ITEM 432-6 | 12Wx12Dx6H

ITEM 432-9 | 12Wx12Dx9H



## B. PORTLAND RECTANGLE RISERS

Specify Color: Black (13), White (15) **NEW**

ITEM 4103-3 | 20¼Wx7Dx3¼H

ITEM 4103-7 | 20¼Wx7Dx7H

ITEM 4103-11 | 20¼Wx7Dx11H



## C. DELI RISERS **NEW**

ITEM 22053-3-13 | 16Wx16Dx3¼H

ITEM 22053-5-13 | 16Wx16Dx5¼H

## D. BAMBOO REVERSIBLE RISERS

Pry Frame Away From Bamboo to Remove It, Then Simply Place Bamboo Back Inside Frame!  
Sides Are: Bamboo (60) and Midnight Bamboo (96).

### SQUARE

ITEM 3725-3 | 12Wx12Dx3½H

ITEM 3725-5 | 12Wx12Dx6H

### ROUND

ITEM 3726-3 | 12DIAx3½H

ITEM 3726-5 | 12DIAx6H



## E. ASHWOOD MARBLE RISERS

Includes Melamine Marble Trays.

ITEM 3680-126-81M | 12DIAx6H

ITEM 3680-153-81M | 15DIAx3¼H

### REPLACEMENT TRAYS

ITEM 3656-12-81M | 12DIAx¾H

ITEM 3656-15-81M | 15DIAx¾H

Please visit [www.calmil.com/legal](http://www.calmil.com/legal) for a complete list of California Proposition 65 related items.

**F. ROUND INDUSTRIAL RISERS**

ITEM 3279-3 | 12DIAx3H

ITEM 3279-5 | 12DIAx5H

ITEM 3279-7 | 12DIAx7H



F

**G. INDUSTRIAL MADERA RISER**

ITEM 3473-99 | 24Wx10Dx12H

G



**H. IRON RISERS**

ITEM 1247-3 | 21Wx7½Dx3¾H

ITEM 1247-7 | 21Wx7½Dx6½H

ITEM 1247-11 | 21Wx7½Dx11½H

H



**I. INDUSTRIAL RECTANGLE RISERS**

ITEM 3418-3 | 20Wx8Dx3H

ITEM 3418-5 | 20Wx8Dx5H

ITEM 3418-7 | 20Wx8Dx7H



I

**J. INDUSTRIAL SQUARE RISERS**

ITEM 3417-3 | 10Wx10Dx3H

ITEM 3417-5 | 10Wx10Dx5H

ITEM 3417-7 | 10Wx10Dx7H



J

Please visit [www.calmil.com/legal](http://www.calmil.com/legal) for a complete list of California Proposition 65 related items.



# riser displays



## A. SIERRA SQUARE RISERS

ITEM 3902-3-84 | 12Wx12Dx3¼H

ITEM 3902-6-84 | 12Wx12Dx6H

ITEM 3902-9-84 | 12Wx12Dx9H



## B. SIERRA RECTANGLE RISERS

ITEM 3901-3-84 | 20½Wx7Dx3¼H

ITEM 3901-7-84 | 20½Wx7Dx7H

ITEM 3901-11-84 | 20½Wx7Dx11H

## C. ROUND MADERA RISERS

ITEM 3668-3-99 | 12DIAx3½H

ITEM 3668-6-99 | 12DIAx6½H

ITEM 3668-9-99 | 12DIAx9½H



## D. ONE BY ONE SILVER TIERED RISER

Includes 3 White Corian Shelves.

ITEM 1140-74 | 32¼Wx13Dx10½H

REPLACEMENT WHITE CORIAN SHELVES

ITEM 1128-1212-15 | 12Wx12Dx¼H



## E. MADERA INDUSTRIAL RISERS

ITEM 3562-3-99 | 8Wx8Dx3½H

ITEM 3562-7-99 | 8Wx8Dx7½H

ITEM 3562-11-99 | 8Wx8Dx11¼H

Please visit [www.calmil.com/legal](http://www.calmil.com/legal) for a complete list of California Proposition 65 related items.



F



**F. EMPIRE RECTANGLE RISERS** **NEW**

ITEM 22087-5-90 | 20½Wx7Dx5H

ITEM 22087-9-90 | 20½Wx7Dx9H

ITEM 22087-13-90 | 20½Wx7Dx13H

G



**G. IRON RISERS**

Specify Top:  
Bamboo (60), Slate (65).

ITEM 1711-3 | 12Wx12Dx3H

ITEM 1711-5 | 12Wx12Dx5H

ITEM 1711-7 | 12Wx12Dx7H

H



**H. CHANGE-UP RISERS**

Frames and Inserts Sold Separately.

**SQUARE ALUMINUM RISERS**

ITEM 1476-12 | 12½Wx12½Dx6H

**OPTIONAL SQUARE INSERTS**

ITEM 1481-12-60 | Large Flat Tray

ITEM 1477-12-60 | Large Deep Tray

I



**I. V-LEG RECTANGULAR METAL RISER SET**

Set of 3 Risers.

ITEM SR630-13 | 12Wx8Dx3H

| 12Wx8Dx7H

| 12Wx8Dx12H

Please visit [www.calmil.com/legal](http://www.calmil.com/legal) for a complete list of California Proposition 65 related items.



# riser displays

A



## A. ROUND MAPLE RISERS

ITEM 3642-9-71 | 9½DIAx6H

ITEM 3642-12-71 | 12DIAx9H

B



## B. SQUARE MAPLE RISERS

ITEM 3641-9-71 | 9½Wx9½Dx6H

ITEM 3641-12-71 | 12Wx12Dx9H

C



## C. METAL FRAMED MAPLE RISERS

ITEM 3659-3-71 | 13½Wx13½Dx3H

ITEM 3659-6-71 | 13½Wx13½Dx6H

ITEM 3659-9-71 | 13½Wx13½Dx9H

D



## D. BAMBOO STAIR-STEP RISERS

ITEM 3374-4-60 | 24Wx11¼Dx4H

ITEM 3374-8-60 | 24Wx11¼Dx8H

ITEM 3374-12-60 | 24Wx11¼Dx12H

E



## E. FOLDING RISERS

Fold Down Flat For Storage!

ITEM 3620-5-60 | 10Wx10Dx5H

ITEM 3620-8-60 | 10Wx10Dx7¾H

ITEM 3620-11-60 | 10Wx10Dx10¾H

Please visit [www.calmil.com/legal](http://www.calmil.com/legal) for a complete list of California Proposition 65 related items.



Create Your Own Custom Insert!

**F. GRANADA SQUARE RISERS**

- ITEM 4029-3-85 | 12½Wx12½Dx4H
- ITEM 4029-6-85 | 12½Wx12½Dx6H
- ITEM 4029-9-85 | 12½Wx12½Dx9H

**G. GRANADA RECTANGLE RISERS**

- ITEM 4030-3-85 | 20½Wx7½Dx4¼H
- ITEM 4030-7-85 | 20½Wx7½Dx7¼H
- ITEM 4030-11-85 | 20½Wx7½Dx11¼H



**H. MADERA RECTANGLE RISERS **NEW****

- ITEM 22066-3-99 | 7Wx20Dx3H
- ITEM 22066-6-99 | 7Wx20Dx6H
- ITEM 22066-9-99 | 7Wx20Dx9H



**I. MADERA SQUARE RISERS **NEW****

- ITEM 22065-3-99 | 12Wx12Dx3H
- ITEM 22065-6-99 | 12Wx12Dx6H
- ITEM 22065-9-99 | 12Wx12Dx9H



**J. MADERA FOLDING RISERS**

- Fold Down Flat For Storage!
- ITEM 3620-5-99 | 10Wx10Dx5H
- ITEM 3620-8-99 | 10Wx10Dx7¾H
- ITEM 3620-11-99 | 10Wx10Dx10¾H

Please visit [www.calmil.com/legal](http://www.calmil.com/legal) for a complete list of California Proposition 65 related items.



# riser displays



A



## A. MONTEREY MERCHANDISERS **NEW**

ITEM 22024-1-13 | 21Wx12¼Dx4¾H  
ITEM 22024-2-13 | 21Wx12¼Dx14¾H

B



## B. ELEVATION RISERS Glass Shelves Not Included.

ITEM 1465-5-13 | 8Wx8Dx5H  
ITEM 1465-10-13 | 8Wx8Dx10H  
ITEM 1465-15-13 | 8Wx8Dx15H  
ITEM 1466-5-13 | 12Wx12Dx5H  
ITEM 1466-10-13 | 12Wx12Dx10H  
ITEM 1466-15-13 | 12Wx12Dx15½H

C



## C. SQUARED METAL CUBE RISERS Glass Shelves Not Included. Black (13), Stainless Steel (55).

ITEM 1607-5-13 | 5Wx5Dx5H  
ITEM 1607-5-55 | 5Wx5Dx5H  
ITEM 1607-7-13 | 7Wx7Dx7H  
ITEM 1607-7-55 | 7Wx7Dx7H  
ITEM 1607-9-13 | 9Wx9Dx9H  
ITEM 1607-9-55 | 9Wx9Dx9H

D



## D. CLASSIC STAIR-STEP RISERS Nesting Sets with Four Sizes Each.

ITEM 237 | Acrylic Black | Set of 4  
ITEM 238 | Acrylic Clear | Set of 4  
ITEM 239 | Stainless | Set of 4  
ITEM 239-2 | 5Wx5Dx2H | Stainless  
ITEM 239-4 | 6Wx6Dx4H | Stainless  
ITEM 239-6 | 7Wx7Dx6H | Stainless  
ITEM 239-8 | 8Wx8Dx8H | Stainless

Please visit [www.calmil.com/legal](http://www.calmil.com/legal) for a complete list of California Proposition 65 related items.



**E. BAMBOO CUPCAKE DISPLAY**

ITEM 1318-60 | 20Wx20Dx17¼H



**F. MADERA 3 TIER RISER DISPLAY**

ITEM 3428-99 | 20¾Wx20¾Dx20H

**G**



**G. MULTI-TIER CONE DISPLAY**

Bamboo Serving Cones Sold Separately.

ITEM 3330-13 | 20DIAx20½H

ITEM CH107 | Sleeve of 300



CH107



**H**

**H. ACRYLIC CONE PEDESTAL**

Hole Size: 1¼" Diameter.

ITEM 1265 | 12Wx12Dx7H

**I. WHITE ACRYLIC SQUARE RISERS**

Stackable or For Individual Use.

ITEM 1917-1-15 | 9½Wx9½Dx4¾H

ITEM 1917-2-15 | 14½Wx14½Dx8H



**I**





# riser displays



A

## A. FAUX GLASS STAIR-STEP RISER

ITEM 1463 | 11½Wx20Dx7H

## B. MADERA ROUND MERCHANDISER **NEW**

ITEM 22063-99 | 13¼DIAx18½H

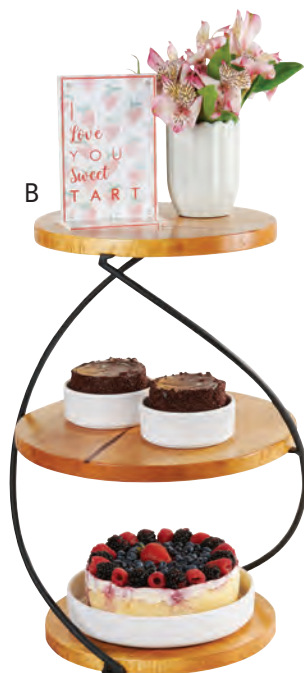

B

## C. GLACIER FAUX GLASS RISERS

ITEM 432-8-43 | 8Wx8Dx8H

ITEM 432-13-43 | 13Wx8Dx6H



C

## D. MONTEREY ROUND RISER **NEW**

ITEM 22022-13 | 12DIAx4H

## E. ACRYLIC MIRROR CUBE RISERS

ITEM MC700 | Set of 3 (8", 10", 12")

ITEM MC708 | 8Wx8Dx8H

ITEM MC710 | 10Wx10Dx10H

ITEM MC712 | 12Wx12Dx12H

## F. GLACIER SQUARE STEP-UP RISER

Includes 3 Faux Glass Platters. Black (13).

ITEM GL1600-13 | 31½Wx14Dx9H

ITEM GL252-43 | Replacement Tray



D



E



F

Please visit [www.calmil.com/legal](http://www.calmil.com/legal) for a complete list of California Proposition 65 related items.



1464-13  
w/1449-99 Shelves

G



1464-13  
w/1449-96 Shelves



1464-48  
w/1449-68 Shelves

G

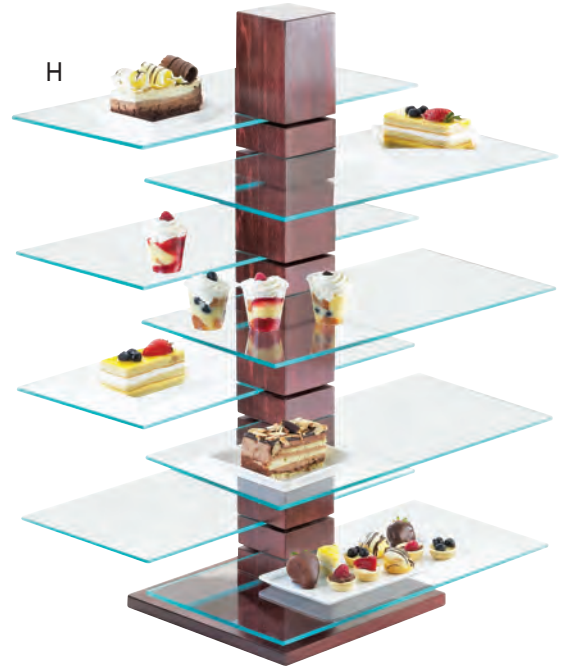

H

### G 3 TIER RISER FRAME

Frame Only. Shelves Sold Separately.  
Specify Frame Color: Black (13), Brown (48).

ITEM 1464 | 18¼Wx11Dx25H

#### OPTIONAL SHELVES

Sold Individually, Not as Sets.  
Specify Color: Bamboo (60), Crushed Bamboo (68),  
Midnight Bamboo (96), Madera (99).

ITEM 1449 | 32Wx11½Dx½H

### H. PILLAR RISERS

Shelves Sold Separately.  
Westport (52).

ITEM 791-52 | 9Wx9Dx32½H

#### OPTIONAL SHELVES

For Square and Round,  
Takes 2 Each to Form Full  
Circle or Full Square.

ITEM 831-SQ | 19¼Wx10D | 1/2 Square

ITEM 831-RD | 19¼Wx10D | 1/2 Round

ITEM C732GLASS | 32Wx7D | Rectangle

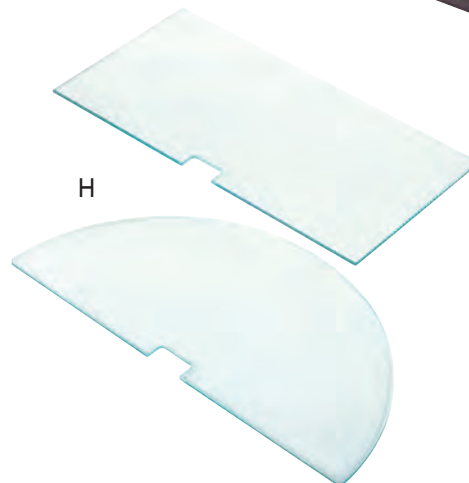

H

Please visit [www.calmil.com/legal](http://www.calmil.com/legal) for a complete list of California Proposition 65 related items.

**CAL•MIL** | visit us online at: [www.calmil.com](http://www.calmil.com) | call toll-free 800-321-9069



# riser displays



A. MADERA FRAME RISER  
ITEM 1940-99 | 28Wx12Dx24H



B. ASHWOOD FRAME RISER  
ITEM 3708-83 | 32Wx13¼Dx25H



C. MIDNIGHT BAMBOO FRAME RISER  
ITEM 1940-96 | 28Wx12Dx24H



D. MID-CENTURY FRAME RISERS  
Specify Color: Brass (46), Chrome (49).  
ITEM 3708 | 32Wx13½Dx25½H

Please visit [www.calmil.com/legal](http://www.calmil.com/legal) for a complete list of California Proposition 65 related items.



**E. SIERRA ELEVATION RISER**  
ITEM 3918-84 | 13½Wx13½Dx25H



**F. SIERRA LIBRARY DISPLAY**  
Accessories Sold Separately.  
Ships by Truck Only.  
ITEM 3903-84 | 38½Wx13½Dx24H



**G. PORTLAND LIBRARY DISPLAY**  
Specify Color: Black (13), White (15) **NEW**  
Ships by Truck Only.  
ITEM 4110 | 37½Wx13½Dx24H



Please visit [www.calmil.com/legal](http://www.calmil.com/legal) for a complete list of California Proposition 65 related items.



# riser displays



A

Madera



B



Midnight  
Bamboo

## A. LIBRARY DISPLAYS

Shelf is Removable.  
Specify Color: Bamboo (60),  
Midnight Bamboo (96), Madera (99).  
Ships by Truck Only.

ITEM 1933 | 38Wx12Dx24H

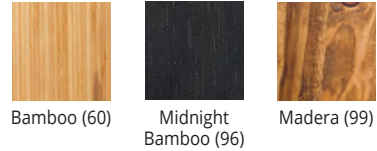

Bamboo (60)

Midnight  
Bamboo (96)

Madera (99)

## B. LIBRARY CUBES

Dimensions: 12Wx12Dx12H.

ITEM 1929-12-60 | Bamboo

ITEM 1929-12-96 | Midnight Bamboo

ITEM 1929-12-99 | Madera



Midnight  
Bamboo



Please visit [www.calmil.com/legal](http://www.calmil.com/legal) for a complete list of California Proposition 65 related items.



**C. MONTEREY MODULAR LIBRARY DISPLAY NEW**

All Pieces Sold Separately.

ITEM 22119-3-13 | 14Wx12Dx3¼H | 3" Base

ITEM 22119-13-13 | 14Wx12Dx13¾H | 13" Cube

ITEM 22124-15 | 42Wx12Dx¾H | White Shelf



Midnight Bamboo

Example of what can be done with Library Displays and Cubes.

Please visit [www.calmil.com/legal](http://www.calmil.com/legal) for a complete list of California Proposition 65 related items.

**CAL•MIL** | visit us online at: [www.calmil.com](http://www.calmil.com) | call toll-free 800-321-9069



# accent bowls & displays



A

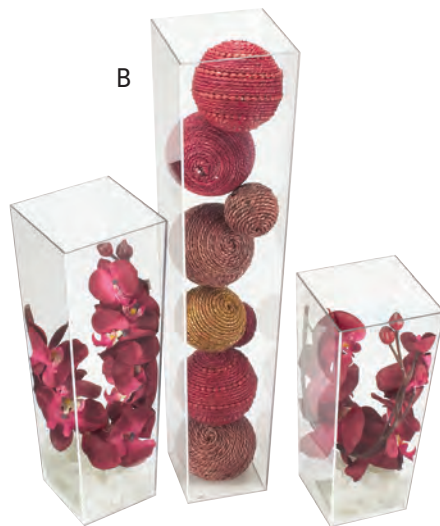

B

## A. SLOPED ACCENT DISPLAYS

Made with Durable PETG.

ITEM 1324-12 | 6DIAx12H

ITEM 1324-16 | 6DIAx16H

ITEM 1324-24 | 6DIAx24H

## B. SQUARE ACCENT DISPLAYS

Made with Durable PETG.

ITEM 879-12 | 5Wx5Dx12H

ITEM 879-16 | 5Wx5Dx16H

ITEM 879-24 | 5Wx5Dx24H



C

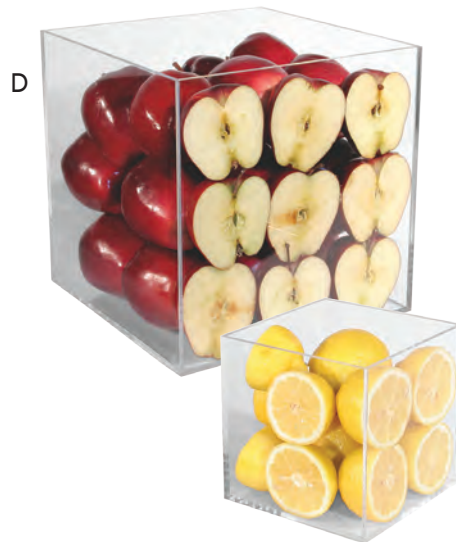

D

## C. ROUND ACCENT DISPLAYS

Made with Durable PETG.

ITEM 872-12 | 4DIAx12H

ITEM 872-16 | 4DIAx16H

ITEM 872-24 | 4DIAx24H

## D. CLEAR ACRYLIC CUBES

Store Inside Each Other To Save Space.

ITEM CC334 | Set of 3 (8", 10", 12")

ITEM CC306 | 6Wx6Dx6H

ITEM CC308 | 8Wx8Dx8H

ITEM CC310 | 10Wx10Dx10H

ITEM CC312 | 12Wx12Dx12H

## E. WHITE PEDESTAL

Constructed of Resin.

ITEM 3588-15 | 12DIAx3H

## F. RESIN MARBLE CYLINDERS

ITEM 3589-34 | 2¾DIAx4½H

ITEM 3589-45 | 4¾DIAx5½H



E



F

Please visit [www.calmil.com/legal](http://www.calmil.com/legal) for a complete list of California Proposition 65 related items.

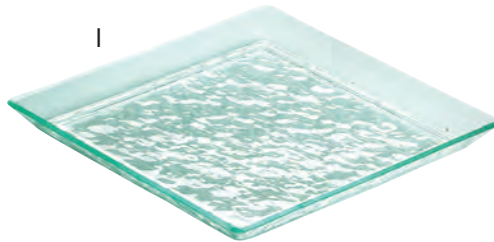
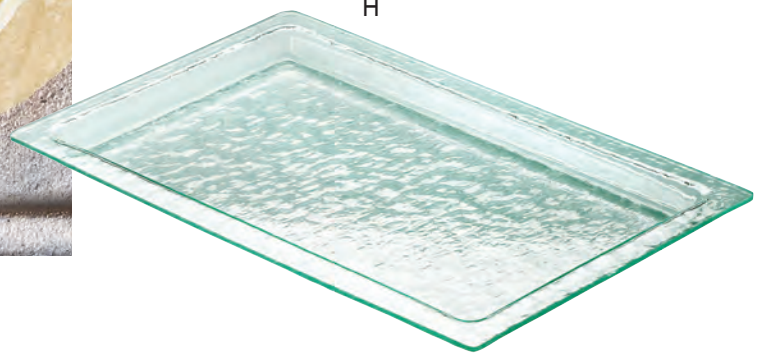
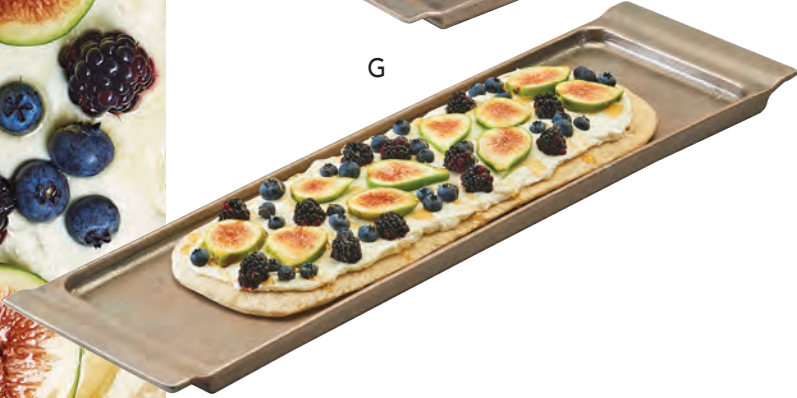

**G. ALUMINUM PLATTERS**

ITEM 3672-915 | 15½Wx9½Dx1½H

ITEM 3672-623 | 23½Wx6½Dx1½H

ITEM 3672-1123 | 23½Wx11½Dx1½H

**H. GLACIER RECTANGULAR TRAY**

ITEM GL11-43 | 21Wx13Dx1H

**I. GLACIER DIAMOND PLATTER**

GL252-43 | 10½Wx10½Dx1H

**J. GLACIER DIAMOND BOWL**

ITEM GL250-43 | 7Wx7Dx3H

**K. SIERRA ACCENT BOWL**

3911-10-84 | 10DIAx6H

**L. WOOD ACCENT BOWL**

3555-14 | 14DIAx3¼H

**M. NATURAL WOOD SLICE TRAY**

3556-17 | 17DIAx1½H



Please visit [www.calmil.com/legal](http://www.calmil.com/legal) for a complete list of California Proposition 65 related items.

**CAL•MIL** | visit us online at: [www.calmil.com](http://www.calmil.com) | call toll-free 800-321-9069



# room service & amenities



**A. MELAMINE WOOD TRAY**  
Hickory Melamine (47M).  
ITEM 3563-47M | 20Wx15½Dx2H

**B. WHITE ABS TRAYS**  
ITEM 3475-1-15 | 16Wx13Dx2¼H  
ITEM 3475-2-15 | 22Wx16Dx2¼H



**C. BAMBOO TRAY**  
ITEM 958-1-60 | 22½Wx17Dx1½H

**D. MELAMINE BAMBOO TRAY**  
ITEM 3563-60M | 20Wx15½Dx2H

Please visit [www.calmil.com/legal](http://www.calmil.com/legal) for a complete list of California Proposition 65 related items.

**E. CLASSIC ABS TRAY**

ITEM 958-2-13 | 16Wx13Dx1½H  
 ITEM 958-1-13 | 22½Wx18Dx1¾H



**F. CLASSIC STACKABLE ABS TRAY**

ITEM 930-2-13 | 16Wx13Dx1H  
 ITEM 930-1-13 | 22½Wx17Dx1H  
 ITEM 930-3-13 | 26Wx18Dx1H



**G. ASHWOOD SERVING TRAY**

ITEM 3701-83 | 12Wx12Dx3½H



**H. MADERA SERVING TRAY**

ITEM 3701-99 | 12Wx12Dx3½H  
 ITEM 3924-99 | 17¼Wx12¼Dx5H



**I. MIDNIGHT BAMBOO TRAY**

ITEM 3559-1-96 | 19Wx14Dx2½H

**J. ACRYLIC AMENITY TRAY**

ITEM 809-12 | 9¾Wx4½Dx2½H



**K. AMENITY TRAY & ORGANIZER**

ITEM 490-12 | 7½Wx9½Dx5½H



Please visit [www.calmil.com/legal](http://www.calmil.com/legal) for a complete list of California Proposition 65 related items.



# room service & amenities



A

B

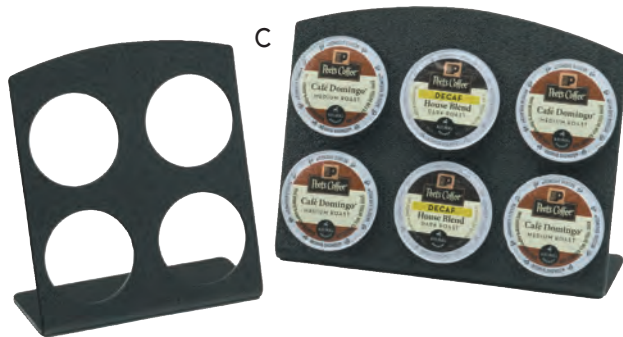

C



D

E

399-13



F

**A. MADERA AMENITY TRAY**  
Reclaimed Wood (99).  
ITEM 3474-99 | 12Wx13Dx1½H

**B. BLACK AMENITY TRAY**  
ITEM 353-13 | 15¼Wx12½Dx2H

**C. K-CUP HOLDERS**  
ITEM 3485-4-13 | 4½Wx2Dx5½H  
ITEM 3485-6-13 | 6¾Wx2Dx5½H

**D. K-CUP & PACKET ORGANIZER**  
ITEM 3579-13 | 5Wx6¾Dx5H

**E. CLASSIC PACKET ORGANIZER**  
ITEM 399-13 | 4Wx3Dx3¼H

**F. EXPANDED CLASSIC PACKET ORGANIZER**  
ITEM 3580-13 | 9½Wx2Dx2¾H

Please visit [www.calmil.com/legal](http://www.calmil.com/legal) for a complete list of California Proposition 65 related items.



3741 - Cylinders Only

A

Item 3740-99 shown with Optional 6 Cylinders and Bracket.



B

**A. MADERA FLOORSTANDING MERCHANDISER**

Floorstanding Base and 6 Cylinder Attachment Sold Separately. Available Only in Madera (99).

ITEM 3740-99 | 40Wx24Dx60H

ITEM 3741 | 37Wx7Dx18¼H

**B. BULK FOODS MERCHANDISER NEW**

Includes 16 Bulk Food Free Flow Dispensers and Crumb Catchers.

ITEM 22108 | 48Wx25Dx85H

**C. CHALKBOARD MERCHANDISER**

ITEM 3607-13 | 15Wx14Dx19H

ITEM 3062-15 | White Chalkboard Pen



C

Please visit [www.calmil.com/legal](http://www.calmil.com/legal) for a complete list of California Proposition 65 related items.



# merchandising displays

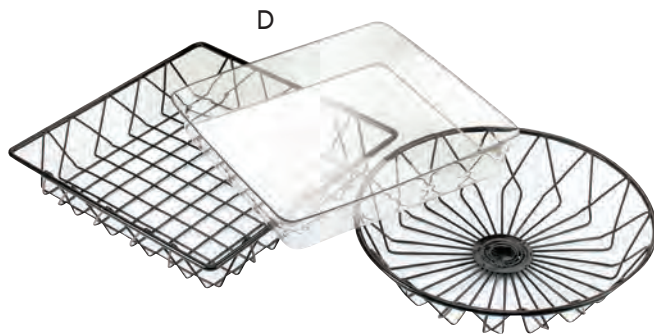

## A. ROUND WIRE MERCHANDISERS

Includes Baskets.

ITEM 1292-2 | 12Wx15Dx15H

ITEM 1292-3 | 12Wx19Dx22H

## B. RECTANGULAR WIRE MERCHANDISERS

Includes Baskets.

ITEM 1291-2 | 18Wx18½Dx14¼H

ITEM 1291-3 | 18Wx22Dx20H

## C. SQUARE WIRE MERCHANDISERS

Includes Baskets.

ITEM 1293-2 | 12Wx15Dx15H

ITEM 1293-3 | 12Wx19Dx20H

## D. TRAYS AND BASKETS

ITEM 1291TRAY | 18Wx12D - Wire

ITEM 1292TRAY | 12 DIA Wire Basket

ITEM 1293TRAY | 12 SQ Wire Basket

## E. MID-CENTURY MERCHANDISERS

Shelves Adjust to Sit Straight or Slanted.  
Specify Color: Brass (46), Chrome (49).

ITEM 3704-2 | 13Wx12Dx16½H

ITEM 3704-3 | 13Wx12Dx26H

Please visit [www.calmil.com/legal](http://www.calmil.com/legal) for a complete list of California Proposition 65 related items.

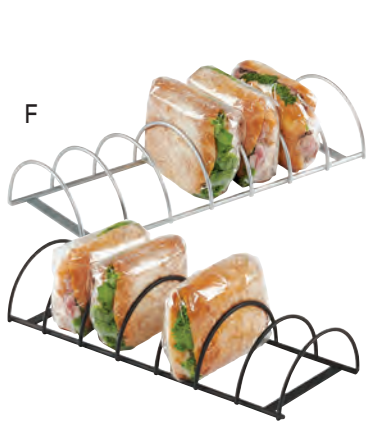

F

**F. SANDWICH ORGANIZERS NEW**  
Specify Color: Black (13), Stainless (55).  
ITEM 22042 | 15¾Wx6Dx3H



1563-3

**G. MISSION ALUMINUM ICE DISPLAY**  
ITEM 1563-2 | 12¾Wx12¾Dx11½H  
ITEM 1563-3 | 15½Wx15½Dx20¼H



G

**H. MONTEREY BOX MERCHANDISERS NEW**  
ITEM 22118-4-13 | 20¼Wx10¼Dx4H  
ITEM 22118-7-13 | 20¼Wx10¼Dx7½H



22118-7-13



H

22118-4-13

**I. MADERA WRITE-ON MERCHANDISER NEW**  
Sits Flat or Locks Standing.  
ITEM 22069-99 | 12¼Wx15¾Dx4¾H



I

**J. WRITE-ON BAGEL DISPLAY NEW**  
Available in Madera (99), White (15). Bagel Sleeves Sold Separately.  
ITEM 22062-99 | 15Wx16Dx4¼H  
ITEM 22062-15 | 15Wx16Dx4¼H



22062-99



J

**K. BAGEL SLEEVES NEW**  
Available in Black (13), White (15).  
ITEM 22061-13 | 15¼Wx4¾Dx2H  
ITEM 22061-15 | 15¼Wx4¾Dx2H

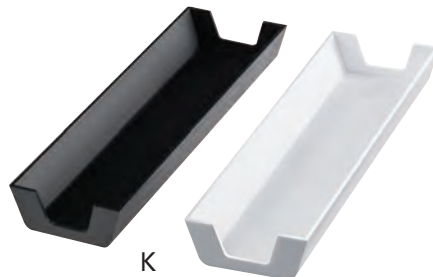

K



22062-15

Please visit [www.calmil.com/legal](http://www.calmil.com/legal) for a complete list of California Proposition 65 related items.



# merchandising displays

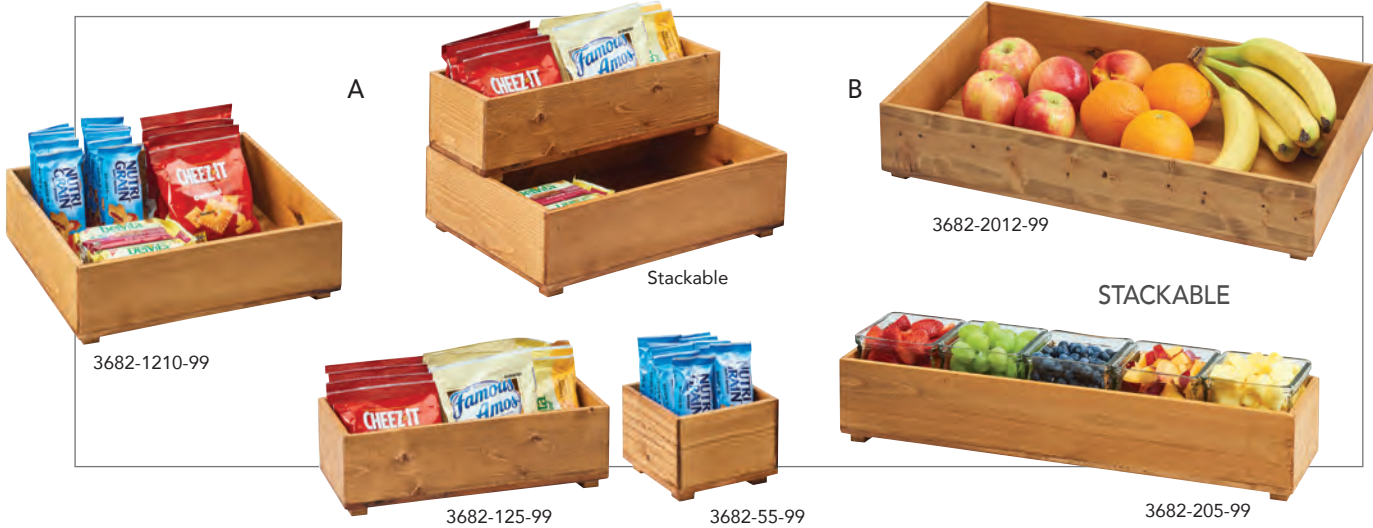

3682-1210-99

A

Stackable

B

3682-2012-99

STACKABLE



3682-125-99



3682-55-99



3682-205-99



C



D



E



F



G

## A. SMALL STACKING BOXES

Madera (99).

ITEM 3682-55-99 | 5Wx5Dx3¼H

ITEM 3682-125-99 | 12Wx5Dx3¼H

ITEM 3682-1210-99 | 12Wx10Dx3¼H

## B. LARGE STACKING BOXES

Madera (99).

ITEM 3682-205-99 | 20Wx5Dx3¼H

ITEM 3682-2012-99 | 20Wx12Dx3¼H

## C. MADERA SHELF RISERS

ITEM 3637-99 | 24Wx12¼Dx24H | 3 Tier

## D. MADERA ADJUSTABLE MERCHANDISER **NEW**

ITEM 22070-99 | 12¼Wx16¾Dx7¾H

## E. ASHWOOD MERCHANDISERS

ITEM 3449-2-83 | 16Wx20Dx9½H

ITEM 3449-3-83 | 16Wx20Dx15½H

## F. SIERRA DUAL DRAWER DISPLAY

Includes Liners.

Drawers Pull Out From Opposite Sides.

ITEM 3920-84 | 21¾Wx15½Dx11½H

## G. SIERRA MERCHANDISER

ITEM 3448-84 | 15¾Wx17Dx13H

Please visit [www.calmil.com/legal](http://www.calmil.com/legal) for a complete list of California Proposition 65 related items.



H



I



J

**H. MADERA MERCHANDISERS**

Shelves Adjustable to Sit  
Straight or Slanted.

ITEM 3494-2-99 | 12Wx12Dx21H

ITEM 3494-3-99 | 12Wx12Dx31H

**I. SIERRA MERCHANDISER CART**

ITEM 3921-84 | 14¾Wx14¼Dx35H

**J. LUXE MERCHANDISER**

ITEM 3448-55 | 15½Wx20¼Dx12¾H

**K. PORTLAND  
MERCHANDISER CART**

Includes Clear Insert Trays.

Specify Color: Black (13), White (15) **NEW**

ITEM 4111 | 15Wx14Dx35H



K

Please visit [www.calmil.com/legal](http://www.calmil.com/legal) for a complete list of California Proposition 65 related items.

**CAL•MIL** | visit us online at: [www.calmil.com](http://www.calmil.com) | call toll-free 800-321-9069



# case displays



**A. MONTEREY DISPLAY CASE NEW**  
Includes (3) White Composite Shelves.  
ITEM 22021-13 | 21Wx18¼Dx23H



**B. WIDE MONTEREY DISPLAY CASE NEW**  
Includes (3) White Composite Shelves.  
ITEM 22116-13 | 26½Wx17Dx26¾H



**C. MADERA PRESENTATION CASES**  
Serving Trays, Signage and Plates Not Included.  
ITEM 3648-822-99 | 20Wx8Dx7¾H  
ITEM 3648-1520-99 | 20Wx15Dx8H

Please visit [www.calmil.com/legal](http://www.calmil.com/legal) for a complete list of California Proposition 65 related items.



Now a reversible design  
for self or attendant serve!  
Featuring 3 different tray positions:  
tilted front, tilted back, and level.

**D. PORTLAND CASE DISPLAY**

Includes 3 – 13x18 Clear Trays.  
Self and Attendant Serve with 3 Tray Positions.

Specify Color: Black (13), White (15) **NEW**.

ITEM 4112 | 19½Wx14½Dx20½H

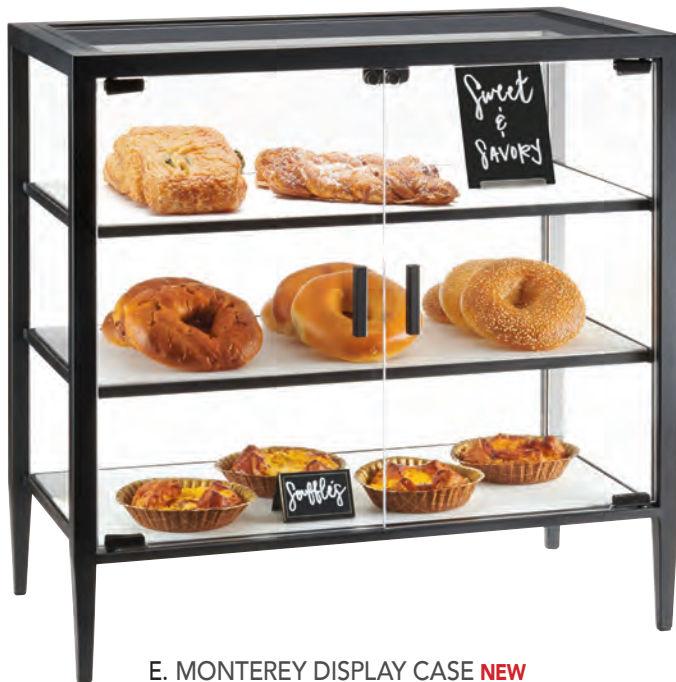

**E. MONTEREY DISPLAY CASE NEW**

Includes (3) White Composite Shelves.

ITEM 22023-26-13 | 14Wx26¼Dx26¼H



**F. MONTEREY SQUARE DISPLAY CASE NEW**

Includes (3) White Composite Shelves.

ITEM 22023-14-13 | 14Wx14Dx26H

Please visit [www.calmil.com/legal](http://www.calmil.com/legal) for a complete list of California Proposition 65 related items.

**CAL•MIL** | visit us online at: [www.calmil.com](http://www.calmil.com) | call toll-free 800-321-9069



# case displays



815-52

Now a reversible design for self or attendant serve! Featuring 3 different tray positions: tilted front, tilted back, and level.

## A. WESTPORT DISPLAY CASE

Includes 3 - 13" x 18" Black Acrylic Trays. Self and Attendant Serve with 3 Tray Positions.

ITEM 815-52 | 21Wx16½Dx18¼H

ITEM 325-13-13 | Replacement Tray



B

## B. SIERRA 2 TIER DISPLAY CASE

Available In Self or Attendant Serve.

ITEM 3931-84 | 19Wx22Dx18½H

ITEM 3931-S-84 | 19Wx22Dx18½H



C

## C. SIERRA SLIDING DOOR CASE

Serving Trays and Plates Not Included. Ships by Truck Only.

ITEM 3611 | 36Wx19½Dx17¼H | Attendant

ITEM 3611-S | 36Wx19½Dx17¼H | Self Serve



D

## D. SIERRA VINTAGE DISPLAY CASE

Sliding Door in Back for Attendant or Self-Serve. Serving Trays and Plates Not Included. Ships by Truck Only.

ITEM 3695-84 | 42Wx17Dx23H

Please visit [www.calmil.com/legal](http://www.calmil.com/legal) for a complete list of California Proposition 65 related items.



E

**E. VINTAGE SQUARE BAKERY CASE**

ITEM 3610 | 21Wx17Dx23¼H



F

**F. MONTEREY BAKERY CASE NEW**

ITEM 4312-15 | 21Wx17Dx23¼H

**G. GRANADA CASE DISPLAY**

Includes 3 – 13" x 18" Clear Acrylic Trays.  
Self and Attendant Serve with 3 Tray Positions.

ITEM 4034-85 | 19¼Wx13½Dx20¼H

ITEM 325-13-12 | Replacement Tray



G

Now a reversible design for self or attendant serve!  
Featuring 3 different tray positions: tilted front, tilted back, and level.

**H. MIDNIGHT BAMBOO BAKERY DISPLAY CASE**

Includes 3 – 13" x 18" Black Acrylic Trays.  
Self and Attendant Serve with 3 Tray Positions.

ITEM 284-96 | 21¾Wx16¼Dx21½H

ITEM 325-13-13 | Replacement Tray

H



284-96

Now a reversible design for self or attendant serve!  
Featuring 3 different tray positions: tilted front, tilted back, and level.

**I. GLACIER DISPLAY CASE**

Includes 3 – 10" x 14" Clear Trays.

ITEM 1501-13 | 16Wx12Dx19H

ITEM 335-10-12 | Replacement 10x14 Tray



1501-13

Please visit [www.calmil.com/legal](http://www.calmil.com/legal) for a complete list of California Proposition 65 related items.



# case displays



A

Now a reversible design for self or attendant serve! Featuring 3 different tray positions: tilted front, tilted back, and level.



B

1574-13



C



D



E

## A. ONE BY ONE SILVER DISPLAY CASE Self-Serve.

Includes 3 – 13x18 Clear Trays.

ITEM 1145-S-74 | 20½Wx17Dx22H

ITEM 325-13-12 | Replacement 13x18 Tray

## B. SOHO DISPLAY CASE

Includes 3 Black Trays.

Self and Attendant Serve with 3 Tray Positions.

ITEM 1574-13 | 17¼Wx12¾Dx20¾H | 10x14 Trays

ITEM 1575-13 | 21¼Wx15¾Dx20¾H | 13x18 Trays

### REPLACEMENT TRAYS

ITEM 335-10-13 | Replacement 10x14 Tray

ITEM 325-13-13 | Replacement 13x18 Tray

## C. 3 LEVEL PASTRY CASE

Includes Case and Set of 13" x 18" Trays.

ITEM PC300-13 | 20Wx16Dx24H

## D. LUXE STEP DISPLAY CASE

Includes 3 – 13" x 18" White Trays.

Stainless Steel Trim (55).

ITEM 3020-55 | 19Wx20Dx19H

ITEM 325-13-15 | Replacement 13x18 Tray

## E. MID-CENTURY PASTRY CASES

Includes Marble Melamine Inserts!

Specify Color: Brass (46), Chrome (49).

ITEM 3706-1511 | 16¼Wx11¼Dx18H

ITEM 3706-1813 | 19½Wx13½Dx18H

## F. CARRARA MARBLE MELAMINE TRAYS

Marble Melamine (81M).

ITEM 3629-712-81M | 7Wx12Dx¾H

ITEM 3629-1511-81M | 14¾Wx10¾Dx¾H

ITEM 3629-1813-81M | 18Wx13Dx¾H



F

Please visit [www.calmil.com/legal](http://www.calmil.com/legal) for a complete list of California Proposition 65 related items.

**G. MADERA PANELED BAKERY CASE**

Includes 3 – 13" x 18" Clear Trays.

ITEM 3621-99 | 25Wx17Dx23H

ITEM 325-13-12 | Replacement Tray



**H. MADERA BAKERY DISPLAY CASE**

Includes 3 – 13" x 18" Clear Trays.

Available in Attendant and Self Serve.

ITEM 3432-99 | 21Wx21½Dx21½H | Attendant

ITEM 3432-S-99 | 21Wx21½Dx21½H | Self Serve

ITEM 3047 | Chalkboard Tents

ITEM 325-13-12 | Replacement Tray



**I. ASHWOOD CASE DISPLAY**

Includes 3 Clear Acrylic Trays.

Self and Attendant Serve with 3 Tray Positions.

ITEM 3838-83 | 20Wx14¾Dx20½H

ITEM 325-13-12 | Replacement Tray

I



Now a reversible design for self or attendant serve! Featuring 3 different tray positions: tilted front, tilted back, and level.



**J. MIDNIGHT BAMBOO**

**EURO WOOD CASE**

Includes 3 – 10" x 14" Black Trays.

Available in Attendant and Self Serve.

ITEM P255-96 | 17Wx17Dx18H

ITEM P255-96S | 17Wx17Dx18H

ITEM 335-10-13 | Replacement Tray

**K. WESTPORT**

**EURO WOOD TRIM CASE**

Includes 3 – 10" x 14" Black Trays.

Available in Attendant and Self Serve.

ITEM P255-52 | 17Wx17Dx18H

ITEM P255-52S | 17Wx17Dx18H

ITEM 335-10-13 | Replacement Tray

**L. IRON DISPLAY CASE**

Includes 3 – 10" x 14" Clear Trays.

Specify Color: Black (13), Brown (48).

ITEM P255 | 15½Wx17Dx16¾H

ITEM 335-10-12 | Replacement Tray



P255-96S



P255-52S



P255-13

Please visit [www.calmil.com/legal](http://www.calmil.com/legal) for a complete list of California Proposition 65 related items.



# case displays

A



B



C



D



## A. CLASSIC DISPLAY CASE

Ships Truck Only! Large Slanted Front.  
Self-Serve. Includes 3 – 18" x 26" Clear Trays.

ITEM P254SS | 26½Wx22½Dx23½H

ITEM P235-12 | Replacement Tray

## C. CLASSIC ATTENDANT-SERVE CASE

Includes 3 – 18" x 26" Clear Trays.

ITEM 1202 | 27Wx20Dx20H

ITEM P235-12 | Replacement Tray

## B. GRAND BAKERY CASE

Small Case Includes 3 Small Trays, 3 Large Trays.  
Large Case Includes 6 Small Trays and 3 Large Trays.  
Assembly Required.

ITEM 3493-13L | 29Wx17Dx29H

ITEM 3493-13S | 20Wx15½Dx21H

ITEM 3047 | Chalkboard Tents

### REPLACEMENT TRAYS

ITEM 3414-15 | 6½Wx14Dx1H

ITEM 3415-15 | 14Wx13Dx1H

## D. CLASSIC SELF-SERVE DISPLAY CASE

Includes 3 – 18" x 26" Clear Trays.

ITEM 1202-S | 27Wx20Dx20H

ITEM P235-12 | Replacement Tray

Please visit [www.calmil.com/legal](http://www.calmil.com/legal) for a complete list of California Proposition 65 related items.

**E. SELF-SERVE IRON DISPLAY CASE**

Includes 3 Clear Trays.

ITEM 1708-1014 | 16Wx15Dx17¼H | 10x14 Trays

ITEM 1708-1318 | 18Wx16Dx21H | 13x18 Trays

**REPLACEMENT TRAYS**

ITEM 335-10-12 | Replacement 10x14 Tray

ITEM 325-13-12 | Replacement 13x18 Tray



**F. IRON DISPLAY CASE**

Straight Front for Self or Attendant Serve.  
Includes 3 Clear Trays.

ITEM 1735-1318 | 19Wx15Dx21¼H | 13x18 Trays

**REPLACEMENT TRAYS**

ITEM 325-13-12 | Replacement 13x18 Tray



Now a reversible design for self or attendant serve! Featuring 3 different tray positions: tilted front, tilted back, and level.

**G. URBAN DISPLAY CASE**

Includes 3 – 13" x 18" Clear Trays.  
Stainless Steel (55). Self and Attendant Serve with 3 Tray Positions.

ITEM 3413-55 | 19¼Wx14¼Dx19¼H

ITEM 325-13-12 | Replacement 13x18 Tray

**H. CLASSIC DISPLAY CASE**

Slant Front. Attendant Serve.  
Includes 2 – 280-T Trays.

ITEM 280 | 10Wx10Dx11H

ITEM 280-T | Replacement Tray



**I. CLASSIC DISPLAY CASE**

Slant Front. Attendant Serve.  
Includes 3 – 280-T Trays.

ITEM P257 | 10Wx13½Dx15H

ITEM 280-T | Replacement Tray



920

**J. STACKABLE DISPLAY CASE**

Includes 13" x 18" Clear Tray.

ITEM 920 | 18½Wx14Dx6H

ITEM 921 | 18½Wx14Dx10H

ITEM 325-13-12 | Replacement Tray



921

Please visit [www.calmil.com/legal](http://www.calmil.com/legal) for a complete list of California Proposition 65 related items.



# case displays



## A. MADERA PASTRY DRAWERS

Sold Individually, Stackable. Liner Included.

ITEM 3416 | 22Wx14½Dx7½H



## B. BAMBOO BAKERY DISPLAY CASE

Includes 3 – 13" x 18" Clear Trays. Self and Attendant Serve with 3 Tray Positions.

ITEM 284-60 | 21Wx16¼Dx22½H

ITEM 325-13-12 | Replacement Tray



## C. SIERRA PASTRY DRAWER

Sold Individually, Stackable. Ships by Truck Only.

ITEM 3694-84 | 48Wx24Dx10H



## D. SIERRA COMPACT PASTRY DRAWER

ITEM 3930-84 | 24Wx24Dx10¼H

E



## E. IRON ROUND BIN DISPLAY

ITEM 1280-2 | 15½Wx17¾Dx17½H

ITEM 1280-3 | 17½Wx16¼Dx25H

REPLACEMENT BINS

ITEM C1280B | Replacement Bin

F



## F. BAMBOO BIN DISPLAYS

ITEM 3397-3-60 | 17Wx23½Dx23½H

REPLACEMENT BINS

ITEM C1280B | Replacement Bin

Please visit [www.calmil.com/legal](http://www.calmil.com/legal) for a complete list of California Proposition 65 related items.

Now a reversible design for self or attendant serve!  
Featuring 3 different tray positions: tilted front, tilted back, and level.

284-52



**G. WESTPORT DISPLAY CASE**

Includes 3 – 13" x 18" Black Trays.  
Self and Attendant Serve with 3 Tray Positions.

ITEM 284-52 | 21¾Wx18½Dx20¼H

ITEM 325-13-13 | Replacement Tray



**H. CLASSIC DISPLAY CASE**

Slant Front Doors. Self Serve.  
Includes 3 – 13" x 18" Clear Trays.

ITEM P241SS | 19Wx17Dx18H



**I. TONGS KIT**

Includes Tongs, Chain, Hook & Tape.

ITEM 267 | Tongs Kit



**J. CLASSIC CAKE/PIE CASE**

Hexagon Front. Rear Door.  
Includes 12" x 12" Shelves.

ITEM 252 | 13Wx12½Dx21½H



P255

**K. CLASSIC EURO DISPLAY CASES**

Euro Front. Rear Door.  
Includes 10" x 14" Clear Trays.

ITEM P255 | 15½Wx17Dx16¼H | (3) 10x14 Trays

ITEM 1019 | 15½Wx12Dx7H | (1) 10x14 Tray

ITEM 335-10-12 | Replacement Tray



1019

Please visit [www.calmil.com/legal](http://www.calmil.com/legal) for a complete list of California Proposition 65 related items.

**CAL•MIL** | visit us online at: [www.calmil.com](http://www.calmil.com) | call toll-free 800-321-9069



# case displays

A



B



## A. CLASSIC DISPLAY CASE

Slant Front. Rear Door.

ITEM 260 | 11½Wx17Dx17H | 10x14 Tray

### REPLACEMENT TRAYS

335-10-12 | Replacement 10x14 Tray

## B. CLASSIC DISPLAY CASE

Slant Front.

Rear Door and Self Serve Front Door.

ITEM 263-S | 11½Wx17Dx17H | 10x14 Tray

ITEM 335-10-12 | Replacement 10x14 Tray

C



D



## C. CLASSIC DISPLAY CASE

Slant Front and Rear Door.

Includes 2 – 10" x 14" Clear Trays.

ITEM 254 | 15Wx13Dx11H

ITEM 335-10-12 | Replacement 10x14 Tray

## D. CLASSIC DISPLAY CASE

Slant Front. Rear Door.

Includes 3 – 10" x 14" Clear Trays.

ITEM 261 | 15½Wx15Dx16H

ITEM 335-10-12 | Replacement 10x14 Tray

E



## E. CLASSIC DISPLAY CASE – U-BUILD

Self-Serve and Attendant Serve Available.

Includes 4 – 13" x 18" Clear Trays.

Assembly Required.

ITEM 1012 | 13½Wx21Dx24½H

ITEM 1012-S | 13½Wx21Dx24½H

ITEM 325-13-12 | Replacement 13x18 Tray

F



## F. CLASSIC DISPLAY CASE – U-BUILD

Self-Serve and Attendant Serve Available.

Includes 3 – 13" x 18" Clear Trays.

Assembly Required.

ITEM 1011 | 19½Wx17Dx16½H

ITEM 1011-S | 19½Wx17Dx16½H

ITEM 325-13-12 | Replacement 13x18 Tray

Please visit [www.calmil.com/legal](http://www.calmil.com/legal) for a complete list of California Proposition 65 related items.



**G. PORTLAND BREAD DISPLAY**  
Specify Color: Black (13), White (15) **NEW**.  
ITEM 4119 | 22¼Wx14¾Dx7H



**H. GRANADA  
VERTICAL BREAD CASE**  
ITEM 4022-85 | 6¾Wx14¾Dx20½H  
ITEM 1204DRAWER | Replacement Bin



**I. GRANADA BREAD DISPLAY**  
ITEM 4025-85 | 19Wx14¾Dx20¼H

**J. CINDERWOOD  
BREAD DISPLAY**  
ITEM 3820-87 | 20Wx13½Dx15H



**K. CINDERWOOD  
VERTICAL BREAD CASE**  
ITEM 3815-87 | 6½Wx13Dx20¼H





# bread displays



A



B



C



D



E

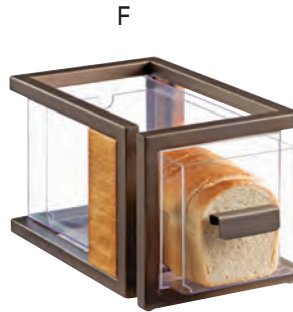

F



G

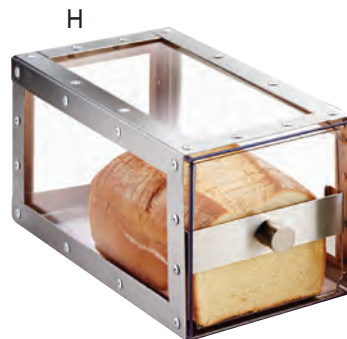

H



I

## A. MADERA 2 BIN BREAD DRAWER

ITEM 4200-2-99 | 13¾Wx13Dx7¼H

## B. MADERA SINGLE BREAD DRAWER

ITEM 4200-1-99 | 7½Wx13Dx6¾H

## C. MADERA BREAD CASE Can be Used Vertically or Horizontally.

ITEM 1204-99 | 8Wx13Dx20½H

ITEM 1204DRAWER | Replacement Bin

## D. MADERA BREAD DISPLAY

ITEM 3624-99 | 20¼Wx12¾Dx13¼H

## E. SIERRA PASTRY DRAWER

ITEM 3928-84 | 22½Wx14¾Dx7½H

## F. SIERRA SINGLE BREAD DRAWER

ITEM 3927-84 | 8Wx12¾Dx8H

## G. SIERRA BREAD DISPLAY

ITEM 3908-84 | 22½Wx14¾Dx13¼H

## H. URBAN BREAD DRAWERS Stackable.

Stainless Steel (55).

ITEM 3410-55 | 6¾Wx12¼Dx6¾H

## I. LUXE BREAD DISPLAY

Stainless Steel Trim (55).

ITEM 3927-55 | 6¾Wx12¼Dx6¾H

Please visit [www.calmil.com/legal](http://www.calmil.com/legal) for a complete list of California Proposition 65 related items.

**J. MONTEREY BREAD CASE NEW**

ITEM 22030-13 | 7Wx13¼Dx20½H



**K. EMPIRE BREAD CASE NEW**

ITEM 22088-90 | 13Wx11¼Dx13¼H



**L. ASHWOOD BREAD CASE**

ITEM 3815-83 | 6½Wx13Dx20¼H



**M. ASHWOOD BREAD DISPLAY**

ITEM 3820-83 | 20Wx13½Dx15H



**N. MIDNIGHT BAMBOO BREAD DISPLAY**

ITEM 3624-96 | 20¼Wx12¾Dx13¼H



**O. BAMBOO 2 DRAWER BREAD CASE**

Stackable; Bamboo Frame, Acrylic Drawers.

ITEM 1337-60 | 14Wx13½Dx5¾H



**P. BAMBOO BREAD DISPLAY**

ITEM 3624-60 | 20¼Wx12¾Dx13¼H



**Q. BAMBOO BREAD DISPLAY CASE**

ITEM 1718-60 | 16½Wx15Dx15H

ITEM C1718DRAWER | Replacement Drawer





# bread displays

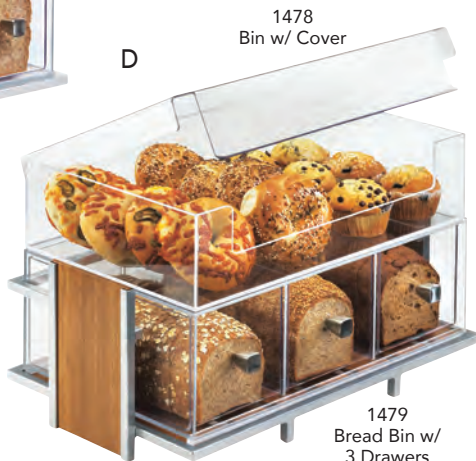

1471  
Frame

1478  
Bin w/ Cover

1479  
Bread Bin w/  
3 Drawers



## A. SOHO BREAD CASE

Specify Color: Black (13), Silver (74).

ITEM 1586 | 14Wx13Dx14¼H

ITEM 1586-13DRAWER | Replacement Drawer

ITEM 1586-74DRAWER | Replacement Drawer

## B. ONE BY ONE 4 DRAWER BREAD CASE

Specify Color: Black (13), Silver (74).

ITEM 1146 | 14Wx14¾Dx15¾H

## C. WESTPORT BREAD DISPLAY CASE

ITEM 813-52 | 16½Wx15Dx15¾H

ITEM 813-52DRAWER | Replacement Drawer

## D. ECO MODERN MERCHANDISERS

Pieces Sold Individually or as a Set.

Set Includes Frame, Bread Bin w/ Drawers,  
and Bin w/ Cover.

### COMPLETE SETS

ITEM 1471-SET | 21Wx13Dx13H | Set/Bamboo

ITEM 1471-15SET | 21Wx13Dx13H | Set/White

### COMPONENTS

ITEM 1471 | Frame Only | Bamboo

ITEM 1471-15 | Frame Only | White

ITEM 1478 | Bin with Cover

ITEM 1479 | Bread Bin with Drawers

ITEM 1479DRAWER | Replacement Drawer

## E. MIDNIGHT BAMBOO BREAD CASE

ITEM 813-96 | 15Wx14½Dx15H

ITEM 813-96DRAWER | Replacement Drawer

## F. ECO MODERN BREAD CASES

ITEM 1279 | 14Wx11½Dx15H - Bamboo

ITEM 1480 | Replacement Bin w/ 2 Drawers

ITEM C1480DRAWER | Replacement Drawer

Please visit [www.calmil.com/legal](http://www.calmil.com/legal) for a complete list of California Proposition 65 related items.

**G. CLASSIC 3 TIER BREAD CASE**

Black (13), Westport (52).

ITEM 1204-13 | 7Wx13Dx21H

ITEM 1204-52 | 8Wx13Dx21H

ITEM 1204DRAWER-13 | Replacement Drawer



1204-13

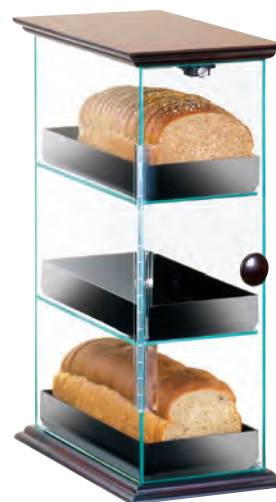

1204-52

**H. IRON DISPLAY WITH ROUND NOSE BINS**

ITEM 1280-2 | 15½Wx17¾Dx17½H

ITEM 1280-3 | 17½Wx16½Dx25H

REPLACEMENT BINS

ITEM C1280B | Replacement Bin for 1280



H



I

**I. BAMBOO BREAD BIN DISPLAY**

ITEM 3397-3-60 | 17Wx23½Dx23½H

REPLACEMENT BINS

ITEM C1280B | Replacement Bin

**J. IRON BREAD CASE**

ITEM 1720-3 | 7Wx12¼Dx19½H

ITEM 1720-4 | 13Wx12½Dx13H

ITEM 1204DRAWER | Replacement Drawer

**K. CLASSIC 3 TIER BREAD CASES**

Can be Used Vertically or Horizontally. Stackable.

ITEM 1204 | 7Wx12Dx20H | Clear/Frost

ITEM 1204-12 | 7Wx12Dx20H | Clear

ITEM 1204P-12 | 7Wx17Dx20H | Pullman Loaf

REPLACEMENT DRAWERS

ITEM 1204DRAWER | 1204 Drawer

ITEM 1204PDRAWER | 1204-P Drawer



1720-4



J

1720-3

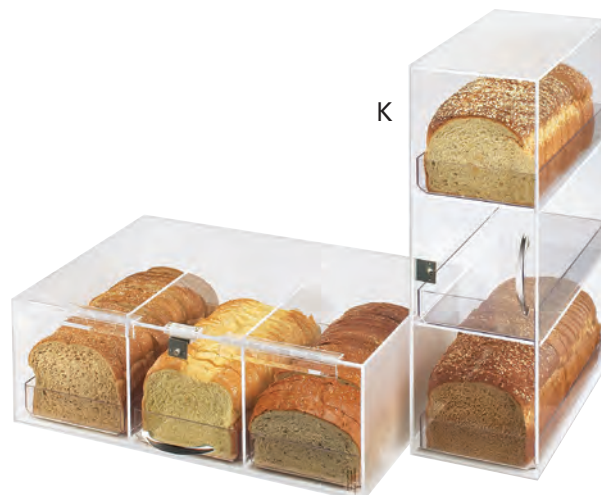

K

Please visit [www.calmil.com/legal](http://www.calmil.com/legal) for a complete list of California Proposition 65 related items.



# bread displays

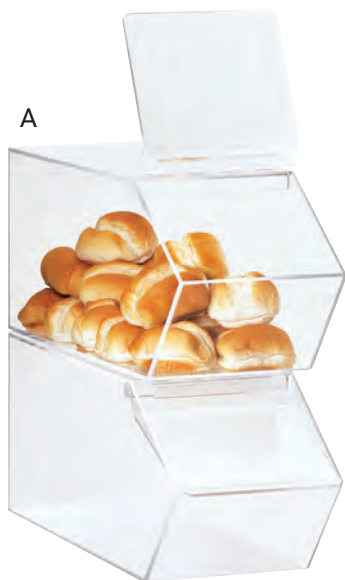

A

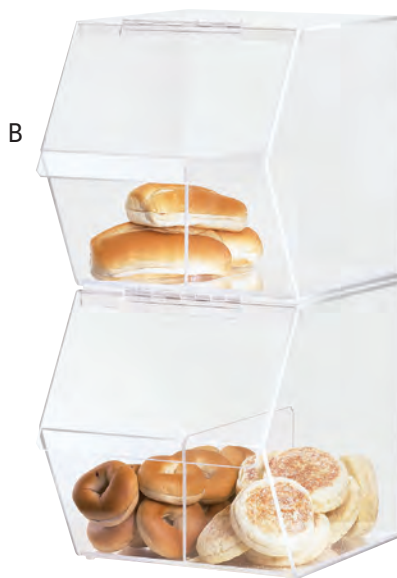

B



C

**A. CLASSIC ACRYLIC STACKABLE FOOD BIN**

Picture Shows 2 Stacked, Sold Individually.

ITEM 992 | 7½Wx19½Dx8H

**B. CLASSIC ACRYLIC STACKABLE FOOD BIN WITH DIVIDER**

Divider is Removable, Picture Shows 2 Stacked, Sold Individually.

ITEM 948 | 11Wx14Dx12H

**C. CLASSIC ACRYLIC BULK FOOD BIN**

ITEM 999 | 7½Wx14Dx9H



D



E

**D. CLASSIC ACRYLIC FOOD BIN WITH KNOB**

ITEM 945 | 12½Wx12½Dx12½H

**E. CLASSIC ACRYLIC FOOD BIN**

ITEM 943 | 12Wx16Dx12½H



F



G

**F. CLASSIC ACRYLIC DIVIDED FOOD BIN**

Divider is Removable.

ITEM 123 | 13Wx16Dx7H

**G. CLASSIC ACRYLIC FOOD BIN**

ITEM 272 | 10Wx10Dx5½H

Please visit [www.calmil.com/legal](http://www.calmil.com/legal) for a complete list of California Proposition 65 related items.

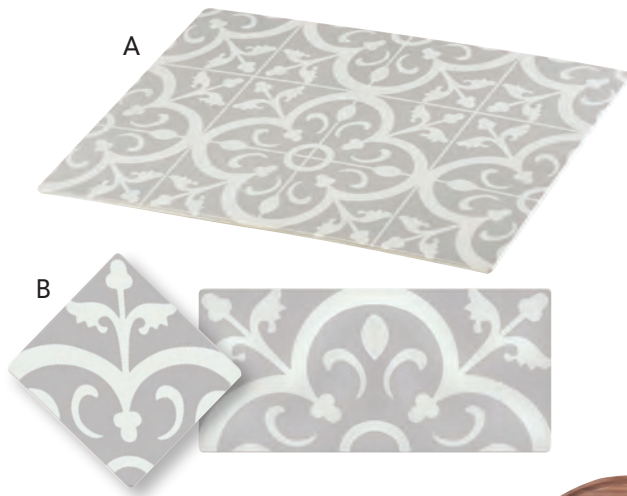

**A. GRANADA SERVING BOARD**  
 Made of Melamine For Easy Cleaning!  
 ITEM 4000-86TILE | 13½Wx18Dx½H

**B. GRANADA SERVING TILES**  
 Made of Melamine For Easy Cleaning!  
 ITEM 3731-86 | 12Wx6Dx¾H  
 ITEM 3732-86 | 6Wx6Dx¾H



**C. ROUND/OVAL WALNUT BOARDS**  
 ITEM 3052-78 | 12DIAx¾H - Round  
 ITEM 3053-78 | 12Wx8Dx¾H - Oval



**D. NATURAL WOOD SLICE TRAY**  
 ITEM 3556-17 | 17DIAx1½H



**E. OAK SERVING BOARDS**  
 ITEM 3496-1111-21 | 11Wx11Dx¾H



Oak Board Profile



**F. CARRARA MARBLE MELAMINE TRAYS**  
 Marble Melamine (81M).  
 ITEM 3629-712-81M | 7Wx12Dx¾H  
 ITEM 3629-1511-81M | 14¾Wx10¼Dx¾H  
 ITEM 3629-1813-81M | 18Wx13Dx¾H  
 ITEM 3656-12-81M | 12DIAx¾H  
 ITEM 3656-15-81M | 15DIAx¾H

Please visit [www.calmil.com/legal](http://www.calmil.com/legal) for a complete list of California Proposition 65 related items.



# tabletop & serving boards



## A. FAUX SLATE PLATTERS

Constructed of Durable Black Melamine.

ITEM SR252-65M | 11½Wx11½Dx1H | Square

ITEM 3459-1515-65M | 15Wx15Dx1H | Square

ITEM 3459-137-65M | 13Wx7Dx1H | Rectangle

ITEM 3459-1310-65M | 13Wx10Dx1H | Rectangle

ITEM 3459-217-65M | 21Wx7Dx1H | Rectangle

ITEM 3459-2113-65M | 21Wx13Dx1H | Rectangle



## B. FAUX SLATE SERVING BOARDS

Constructed of Durable Black Melamine.

ITEM 1522-712-65M | 7Wx12Dx½H | Rectangle

ITEM 1522-1014-65M | 10Wx14Dx½H | Rectangle

ITEM 1522-1020-65M | 10Wx20Dx½H | Rectangle

ITEM 1522-1212-65M | 12Wx12Dx½H | Square

ITEM 3502-12-65M | 12DIAx½H | Round



## C. BLACK SLATE SERVING STONES

ITEM 1522-712-65 | 7Wx12Dx¼H | Rectangle

ITEM 1522-1014-65 | 10Wx14Dx¼H | Rectangle

ITEM 1522-1020-65 | 10Wx20Dx¼H | Rectangle

ITEM 1522-1212-65 | 12Wx12Dx¼H | Square

ITEM 1522-44-65 | 4Wx4Dx¼H | Square

ITEM 1523-12-65 | 12DIAx¼H | Round



## D. FAUX CEMENT SERVING BOARDS

Constructed of Durable Melamine.

ITEM 1522-712-77 | 7Wx12Dx½H | Rectangle

ITEM 1522-1014-77 | 10Wx14Dx½H | Rectangle

ITEM 1522-1020-77 | 10Wx20Dx½H | Rectangle

Please visit [www.calmil.com/legal](http://www.calmil.com/legal) for a complete list of California Proposition 65 related items.



**E. PRETZEL & CONDIMENT STANDS**

White Melamine Ramekins Included.  
 ITEM 4201 | 6½Wx7Dx12½H | Holds 1 Pretzel  
 ITEM 4202 | 6½Wx7Dx12½H | Holds 2 Pretzels



F

**F. ROUNDED SERVING BOARDS**

Can Withstand up to 350° F.  
 Black (13), Natural (14).  
 ITEM 1531-612-13 | 12Wx6Dx¼H  
 ITEM 1531-612-14 | 12Wx6Dx¼H  
 ITEM 1531-616-13 | 15½Wx6Dx¼H  
 ITEM 1531-616-14 | 15½Wx6Dx¼H



G

**G. SERVING BOARDS WITH HANDLE**

Can Withstand up to 350° F.  
 Black (13), Natural (14).  
 ITEM 1535-12-13 | 11¾Wx8Dx¼H  
 ITEM 1535-16-13 | 15¾Wx8Dx¼H  
 ITEM 1535-16-14 | 15¾Wx8Dx¼H  
 ITEM 1535-24-13 | 23¾Wx8Dx¼H



H

**H. FLAT SERVING BOARDS**

Can Withstand up to 350° F.  
 Black (13), Natural (14).  
 ITEM 1530-616-13 | 16Wx6Dx¼H  
 ITEM 1530-616-14 | 16Wx6Dx¼H



I

**I. GLASS PITCHERS & CADDY**

Caddy Includes 6 - 34 Ounce Glass Pitchers.  
 ITEM 3660-13 | 11Wx7½Dx14H | Caddy  
 ITEM 3674-34 | Replacement Glass Pitcher



J

**J. MADERA TABLE CADDIES**

ITEM 3669-99 | 15¾Wx5Dx2½H | 3 Section  
 ITEM 3691-99 | 10¼Wx5Dx5½H | 6 Section  
 ITEM 3692-99 | 9¾Wx8Dx7½H | 4 Section



3692-99



3691-99

3669-99

Please visit [www.calmil.com/legal](http://www.calmil.com/legal) for a complete list of California Proposition 65 related items.



# tabletop & serving boards

## A. STAINLESS STEEL FRENCH FRY HOLDER

ITEM 3441-55 | 4½Wx2½Dx3¾H

## B. FAUX SLATE FRENCH FRY HOLDER

Constructed of Faux Slate Melamine.  
ITEM 3441-65M | 4½Wx2½Dx3¾H

## C. CONCAVE FRENCH FRY HOLDER

Constructed of Faux Slate Melamine.  
ITEM 3600-65M | 4¼DIAx4¼H

## D. CONE WIRE FRENCH FRY HOLDER

ITEM 3468 | 5DIAx10½H

## E. ROUND BASKET SIDE SERVER

ITEM 3443 | 3½DIAx3¾H

## F. MADERA RESTAURANT CARD HOLDER

ITEM 3734-99 | 2¾Wx2¾Dx4H

## G. MELAMINE ENAMELWARE SERVING TRAY & ACCESSORIES

ITEM 3462-15 | 3½DIAx5H | French Fry Holder

ITEM 3463-15 | 13Wx9Dx1H | Tray

ITEM 3467-4-15 | 4½DIAx1¼H | Bowl

## H. WIRE BREAD BASKET

ITEM 22009-13 | 6½DIAx3½H

## I. MELAMINE LARGE SQUARE PLATTER

ITEM SR252 | 11¾Wx11¾Dx1½H

## J. WIRE TACO STANDS

ITEM 3476-2 | 2½Wx4½Dx1¾H | 2 Tacos

ITEM 3476-3 | 2½Wx6½Dx1¾H | 3 Tacos

## K. STAINLESS STEEL TACO STAND

Holds 2-3 Tacos.

ITEM 3479-55 | 7Wx3Dx2H

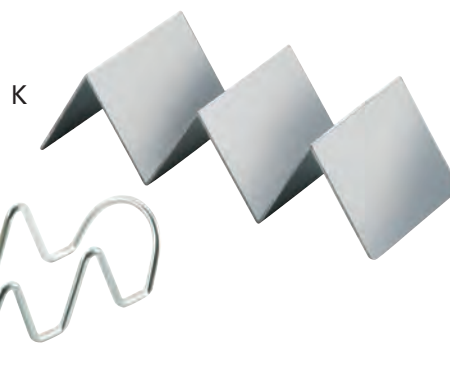

Please visit [www.calmil.com/legal](http://www.calmil.com/legal) for a complete list of California Proposition 65 related items.



M E L A M I N E



L. MODULAR MELAMINE  
SERVING TRAYS **NEW**

All Trays Are Stackable and Can Be Arranged Together in Countless Variations.

Specify Color: Black (13), White (15), Natural Wood (91).

ITEM 22097 | 4Wx4Dx½H

ITEM 22098 | 8Wx4Dx½H

ITEM 22099 | 9Wx9Dx½H

ITEM 22100 | 13Wx9Dx½H



Please visit [www.calmil.com/legal](http://www.calmil.com/legal) for a complete list of California Proposition 65 related items.



# tabletop & serving boards



Please visit [www.calmil.com/legal](http://www.calmil.com/legal) for a complete list of California Proposition 65 related items.



**A. MELAMINE  
SERVING TRAYS NEW**

Specify Color:  
White (15), Stoneware (89).  
Trays are Stackable.

- ITEM 22027 | 4DIAx1½H | Ramekin
- ITEM 22017-8 | 8¼DIAx1½H | 8" Plate
- ITEM 22017-10 | 10DIAx1½H | 10" Plate
- ITEM 22017-12 | 12DIAx1½H | 12" Plate
- ITEM 22013-10 | 10DIAx2½H | 10" Bowl
- ITEM 22018 | 14Wx11¼Dx1H | Platter



A

**B. RISERS FOR MELAMINE  
SERVING TRAYS NEW**

Specify Color: White (15),  
Bronze (84).

- ITEM 22016-4 | 11DIAx4H | Fits 10" Plate/Bowl
- ITEM 22016-7 | 11DIAx7H | Fits 10" Plate/Bowl
- ITEM 22125-4 | 13DIAx4H | Fits 12" Plate
- ITEM 22125-7 | 13DIAx7H | Fits 12" Plate
- ITEM 22014-4 | 13¼Wx11¼Dx4H | Fits Platter
- ITEM 22014-7 | 13¼Wx11¼Dx7H | Fits Platter



B



Please visit [www.calmil.com/legal](http://www.calmil.com/legal) for a complete list of California Proposition 65 related items.



# straw & toothpick organizers

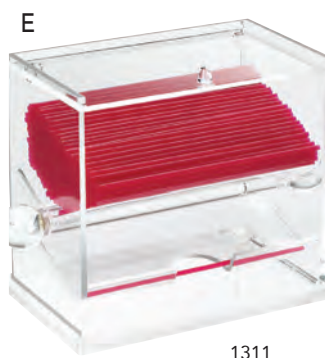
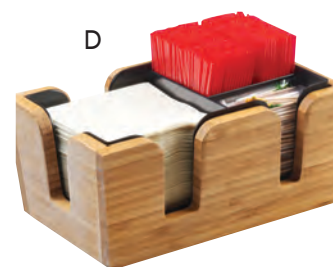

## A. ASHWOOD STIR-STICK HOLDER

ITEM 3308-83 | 5Wx5Dx5½H

## B. MADERA STIR-STICK HOLDER

ITEM 3308-99 | 5¼Wx5¼Dx5½H

## C. CLASSIC STIR-STICK HOLDER

ITEM 3308-13 | 5Wx5Dx5¼H

## D. BAR ORGANIZERS

Specify Color: Bamboo (60), Madera (99).

ITEM 3499 | 10¾Wx7Dx4¾H

## E. CLASSIC STRAW/STIR-STICK ORGANIZER

ITEM 1311 | 6Wx3½Dx5½H

ITEM 296 | 6½Wx5¼Dx8¼H

## F. FAUX GLASS STRAW/STIR STICK HOLDERS

ITEM 1228 | 3½Wx3½Dx3½H

ITEM 1228-4 | 4¾Wx4¾Dx5½H

## G. CLASSIC TOOTHPICK DISPENSER

ITEM 295 | 3¾Wx3¼Dx5¼H

ITEM 304 | 4½Wx3½Dx5¼H

## H. STAINLESS STEEL STIR-STICK HOLDER

ITEM 4302 | 2DIAx2¾H

## I. 3 JAR STRAW/STIR STICK HOLDER

Includes 3 Jars and Cut Out Lids.

ITEM 3334-13 | 12¾Wx5Dx5¾H

Please visit [www.calmil.com/legal](http://www.calmil.com/legal) for a complete list of California Proposition 65 related items.



**A. ACRYLIC TOPPING DRAWERS**  
Notched Drawers to Accommodate Spoons.

ITEM 287 | 13Wx8Dx5H - 8 Drawer

ITEM 393 | 13Wx8Dx5H - 4 Drawer

**B. ACRYLIC CONE HOLDERS**

ITEM 3601-2 | 7¼Wx3½Dx5¾H

ITEM 3601-4 | 7Wx7Dx6H

**C. 1/2 OZ. CANDY SCOOP**

Accommodates All Notched and Holster Topping Dispensers!

ITEM 1029-1L | 1½Wx1Dx8¼H

**D. ACRYLIC CONE HOLDERS**

Waffle or Standard 2" Diameter.

ITEM 396 | 7Wx7Dx4H

ITEM 398 | 12Wx4Dx4½H

**E. REVOLVING YOGURT CUP DISPENSER**

Holds up to 4½" Diameter Cups.

ITEM 1539-12 | 10Wx10Dx16¾H

**F. CUP & DOME LID HOLDER**

Holds up to 3.75" Diameter Cups & Lids.

Made with Durable ABS.

ITEM 724 | 15½Wx5Dx12H



Please visit [www.calmil.com/legal](http://www.calmil.com/legal) for a complete list of California Proposition 65 related items.



# yogurt & ice cream



3524-1-13

3534-1-13



3533-1-13

3523-1-13

## A. PRO PORTION 1.5 & 5 LITER FREESTANDING DISPENSERS

Portion Controlled Topping Dispenser  
Includes 5 Interchangeable Portion  
Cassettes from 2-7 Tsp.

ITEM 3524-1-13 | 6Wx8Dx16¼H

ITEM 3534-1-13 | 6Wx8Dx23H

### REPLACEMENT PORTION CASSETTE PACK

ITEM 3530-PKIT | 10,15,20,30, and 35 CC's

## B. PRO PORTION 1.5 & 5 LITER WALL MOUNT DISPENSERS

Portion Controlled Topping Dispenser  
Includes 5 Interchangeable Portion  
Cassettes from 2-7 Tsp.

Wall Mounting Hardware  
Not Included.

ITEM 3533-1-13 | 6¼Wx7¾Dx9½H

ITEM 3523-1-13 | 6Wx6Dx16H

### REPLACEMENT PORTION CASSETTE PACK

ITEM 3530-PKIT | 10,15,20,30, and 35 CC's



## C. ACRYLIC CONE CABINET

Hole Size: Waffle or Standard  
2" Diameter.

ITEM 386 | 12Wx12Dx15H

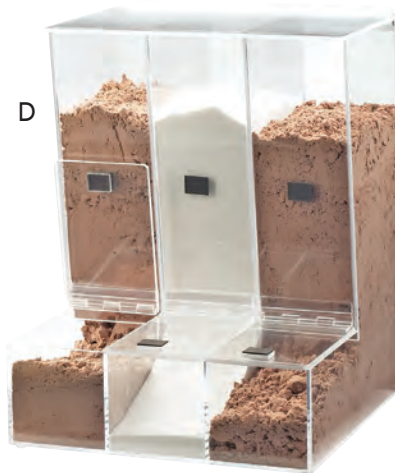

## D. CLASSIC ACRYLIC PROTEIN POWDER BINS

ITEM 946 | 13Wx12Dx16½H | 3 Bin

ITEM 947 | 4½Wx12Dx16½H | 1 Bin



## E. ACRYLIC CONE HOLDER W/GUARD

Hole Size: Waffle or Standard  
2" Diameter.

ITEM 394 | 20Wx4Dx16H



## F. ACRYLIC CONE HOLDER W/ ANGLED GUARD

Hole Size: Waffle or Standard  
2" Diameter.

ITEM 297 | 19Wx6Dx16H

Please visit [www.calmil.com/legal](http://www.calmil.com/legal) for a complete list of California Proposition 65 related items.



**G. STACKABLE TOPPING DISPENSERS**

Holster (H), Notch (N).  
 ITEM 927 | 4Wx11Dx7H  
 ITEM 927-H | 4Wx11Dx7H  
 ITEM 927-N | 4Wx11Dx7H  
 ITEM 1029-1L | 1/2 oz. Spoon



**H. STACKABLE TOPPING DISPENSERS**

Holster (H), Notch (N).  
 ITEM 492 | 4½Wx11Dx5½H  
 ITEM 492-H | 4½Wx11Dx5½H  
 ITEM 492-N | 4½Wx11Dx5½H  
 ITEM 1029-1L | 1/2 oz. Spoon



**I. TALL TOPPING DISPENSERS**

Holster (H), Notch (N).  
 ITEM 373 | 4Wx11Dx11H  
 ITEM 373-H | 4Wx11Dx11H  
 ITEM 373-N | 4Wx11Dx11H  
 ITEM 1029-1L | 1/2 oz. Spoon



**J. CLASSIC ACRYLIC TOPPING DISPENSER**

ITEM 1739 | 4¼Wx12Dx7H  
 ITEM 1029-1L | 1/2 oz. Spoon



For Additional SneezeGuards See Pages 216 - 221.



Holster (H)



Notch (N)



# mirrors & serving stones



**A. ROUND 3 TIER MIRROR RISER**  
ITEM MT240 | 24DIAx18¾H



**B. YING YANG 2 PIECE MIRROR SET**  
ITEM PT245 | 24DIAx¼H



**C. RECTANGULAR MIRROR TRAYS**  
ITEM PT243 | 23Wx17Dx¼H  
ITEM PT323 | 22Wx32Dx¼H

Please visit [www.calmil.com/legal](http://www.calmil.com/legal) for a complete list of California Proposition 65 related items.

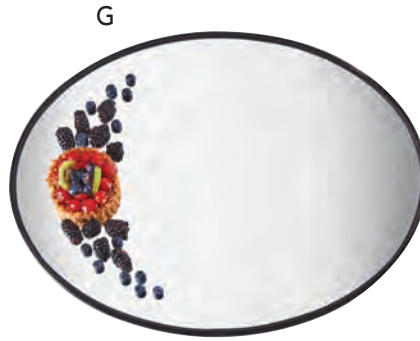

**D. RECTANGULAR MIRROR TRAY WITH BLACK TRIM**

- ITEM RR243 | 24Wx18Dx1H
- ITEM RR323 | 24Wx32Dx1H
- ITEM RR403 | 28Wx40Dx1H

**E. OCTAGON MIRROR TRAY WITH BLACK TRIM**

- ITEM RR241 | 24DIAx1H

**F. ROUND MIRROR TRAY WITH BLACK TRIM**

- ITEM RR240 | 24DIAx1H

**G. OVAL MIRROR TRAY WITH BLACK TRIM**

- ITEM RR242 | 24Wx18Dx1H
- ITEM RR322 | 24Wx32Dx1H

**H. ROUND MIRROR TRAYS**

- ITEM 414-10 | 10DIAx¼H
- ITEM 414-12 | 12DIAx¼H
- ITEM 414-16 | 16DIAx¼H
- ITEM 414-24 | 24DIAx¼H

**I. SMALL SQUARE MIRROR TRAY**

- ITEM 411-12 | 12Wx12Dx¼H

**J. ROUND GLASS MIRROR TRAY**

- ITEM GT12 | 12DIAx¼H

**K. 24 PIECE ROUND MIRROR KIT**

- ITEM GT1288 | 12DIAx¼H - 24 Piece Kit

Please visit [www.calmil.com/legal](http://www.calmil.com/legal) for a complete list of California Proposition 65 related items.

**CAL•MIL** | visit us online at: [www.calmil.com](http://www.calmil.com) | call toll-free 800-321-9069



# mirrors & serving stones

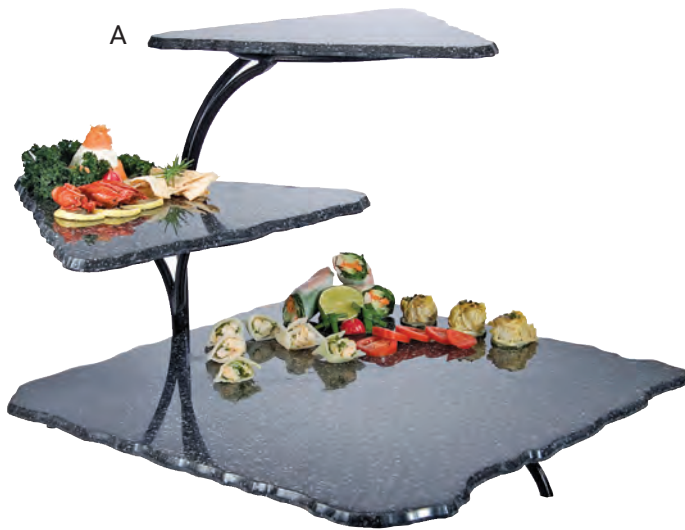

A

**A. METAL 3 TIER  
SIMULATED STONE RISER**  
Black Pearl (31).

ITEM SS800-31 | 20Wx30Dx18H



B

**B. SIMULATED STONE  
MULTI-LEVEL RISER**  
Black Pearl (31).

ITEM DE1030-31 | 18Wx18Dx8½H

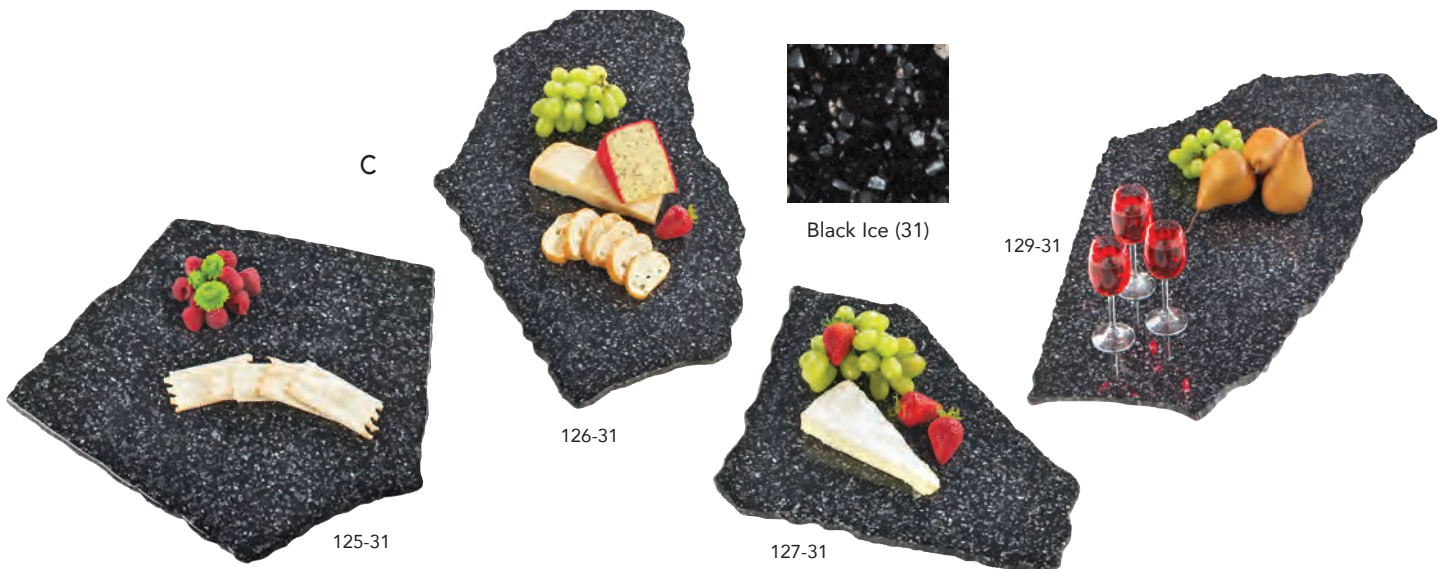

C

**C. BLACK ICE X-STONE TRAYS**

ITEM 125-31 | 15Wx15Dx½H

ITEM 126-31 | 24Wx16Dx½H

ITEM 127-31 | 15Wx12Dx½H

ITEM 129-31 | 30Wx18Dx½H

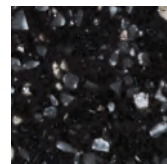

Black Ice (31)

125-31

126-31

127-31

129-31

Please visit [www.calmil.com/legal](http://www.calmil.com/legal) for a complete list of California Proposition 65 related items.



**H. STAINLESS STEEL CARVING STATION**  
 Maple Cutting Board. Heat Lamp Included.  
 ITEM 3037-55 | 20Wx16Dx4H  
 ITEM 3495 | Replacement Lamp



**I. MAPLE CARVING STATION W/ LAMP**  
 Heat Lamp Included.  
 ITEM 3490-71 | 20Wx24Dx11½H  
 ITEM 3495 | Replacement Lamp



**J. CUT-MATE® HIGH HEAT CARVING STATION**  
 Specify Color: Westport (52), Lightwood (53).  
 ITEM 810\* | 22Wx18Dx4H  
 \*Note: High Heat Board Maximum Temperature 325°F.  
 Black Tray Maximum Temperature 180°F.  
 Accommodates Most Standard Heat Lamps.



**K. MADERA CARVING STATION**  
 ITEM 3683-99 | 22½Wx18¼Dx4½H



**L. CUTTING BOARDS**  
 Specify Color: Black (13), Natural Wood (14).  
 ITEM 3337-612 | 6Wx12Dx½H  
 ITEM 3337-1218 | 12Wx18Dx½H  
 ITEM 3337-1520 | 15Wx20Dx½H  
 ITEM 3337-1824 | 18Wx24Dx½H | N/A in Natural Wood

Please visit [www.calmil.com/legal](http://www.calmil.com/legal) for a complete list of California Proposition 65 related items.



# condiment & packet displays

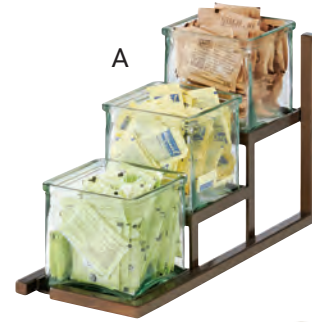

**A. SIERRA 3 JAR TIERED DISPLAY** **NEW**  
Glass Jars Included.

ITEM 4304-84 | 5Wx12¾Dx8H

**B. BAMBOO/MIDNIGHT BAMBOO JAR DISPLAY**

Glass Jars Included.

ITEM 1486 | 5Wx14Dx13H | Bamboo

ITEM 1486-96 | 5Wx14Dx13H | Midnight Bamboo

**C. ONE BY ONE JAR DISPLAY**

Glass Jars Included.

Colors: Black (13), Silver (74).

ITEM 1149 | 6¼Wx13¼Dx11½H

**D. LUXE STAIR STEP JAR DISPLAY**

Stainless Steel (55).

ITEM 3003-55-12 | 4½Wx12¼Dx9H | Glass Jars

ITEM 3003-55-15 | 4½Wx12¼Dx9H | White Melamine Jars

**E. MADERA SINGLE JAR DISPLAYS**

Includes Glass Jar. Reclaimed Wood (99).

ITEM 3427-3-99 | 4½Wx4½Dx3H

ITEM 3427-5-99 | 4½Wx4½Dx5H

ITEM 3427-7-99 | 4½Wx4½Dx7H

**F. SQUARED 3 JAR DISPLAY**

Black (13), Stainless Steel (55).

ITEM 1604-13 | 4Wx12Dx10½H

ITEM 1604-55 | 4Wx12Dx10½H

Please visit [www.calmil.com/legal](http://www.calmil.com/legal) for a complete list of California Proposition 65 related items.

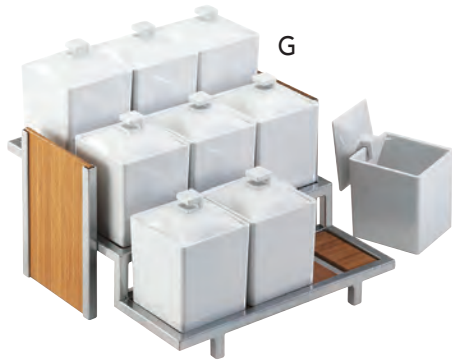

C4X4-15



C1432BODY



22107-55



22055-4-12

K



C4x4GLCN



1807



1811

K



C4X4-96



C4X4-60

### G. ECO MODERN 9 JAR STAND

White Melamine and Glass Jars  
Not Included.

ITEM 1474 | 13¾Wx13¾Dx7H | Bamboo

ITEM 1474-15 | 13¾Wx13¾Dx7H | White

ITEM C4X4GLCN | 4Wx4Dx4H | Glass Jars

ITEM C1432BODY | 4Wx4Dx4H | Melamine Jars

### I. IRON 9 GLASS JAR DISPLAY

Specify Color: Black (13), Platinum (39).  
Glass Jars Included.

ITEM 1812 | 13Wx9½Dx17½H

### H. LUXE 9 BIN/JAR CONDIMENT DISPLAY

Stainless Steel Trim (55).

ITEM 3018-55-12 | 12¼Wx9Dx15½H | Glass Jars

ITEM 3018-55-15 | 12¼Wx9Dx15½H | Melamine Jars

### J. IRON 9 BIN DISPLAYS

Dimensions: 13Wx9½x17½.

ITEM 1817-13 | Black Stand/Bamboo Bins

ITEM 1817-39 | Chrome Stand/Bamboo Bins

ITEM 1817-96 | Black Stand/Midnight Bins

### K. EXTRA JARS AND LIDS

Dimensions: 4Wx4Dx4H

ITEM 22107-55 | Stainless Steel **NEW**

ITEM 22055-4-12 | Polycarbonate **NEW**

ITEM C4X4GLCN | Glass Jar

ITEM C1432BODY | White Melamine Jar

ITEM C4X4-15 | White/Clear Acrylic Bin

ITEM C4X4-60 | Bamboo Bin

ITEM C4X4-96 | Midnight Bamboo Bin

#### OPTIONAL LIDS

ITEM 1807 | S/S Hinge Lid for C4X4GLCN

ITEM 1807-N | S/S Notched Hinge Lid for C4X4GLCN

ITEM 1811 | Plastic Hinge Lid for C4X4GLCN

ITEM 1811-N | Plastic Notched Lid for C4X4GLCN

ITEM C1432LID | Lid for C1432BODY

ITEM C1432NL | Notched Lid for C1432BODY



# condiment & packet displays



A



B



C



D



E



F



G

## A. IRON JAR DISPLAY

Glass Jars Included. Lids Sold Separately.  
Specify Color: Black (13), Platinum (39).

ITEM 1809 | 14Wx9Dx7H

## B. IRON GLASS JAR DISPLAY

Glass Jars Included. Black (13).

ITEM 1804-13 | 12½Wx11Dx13H

## C. IRON JAR DISPLAY

Glass Jars Included.

Specify Color: Black (13), Chrome (49).

ITEM 1803-4 | 4Wx12Dx10½H

## D. IRON ICED JAR DISPLAY

Glass Jars Included.

Specify Color: Black (13), Platinum (39).

ITEM 1806-5 | 13½Wx5½Dx7H

ITEM 1806-7 | 13½Wx5½Dx9H

## E. SIERRA CONDIMENT ORGANIZER

ITEM 3926-84 | 12¾Wx5Dx2¾H

## F. LUXE CONDIMENT AND STIR STICK ORGANIZER

Stainless Steel Trim (55).

ITEM 3013-55 | 8¾Wx6Dx5H

## G. ALUMINUM JAR RISER

Glass Jars Included.

ITEM 1560-2 | 12Wx4¼Dx2H

ITEM 1560-4 | 12Wx4¼Dx4H

Please visit [www.calmil.com/legal](http://www.calmil.com/legal) for a complete list of California Proposition 65 related items.

**H. EMPIRE 9 SECTION ORGANIZER NEW**

ITEM 22093-90 | 11¾Wx11½Dx6H



**I. GRANADA 9 SECTION ORGANIZER**

ITEM 4033-85 | 12Wx12Dx4½H



**J. ASHWOOD 9 JAR DISPLAY**

Glass Jars Included.

ITEM 3831-83 | 13¼Wx12½Dx6½H



**K. CINDERWOOD JAR DISPLAYS**

Glass Jars Included.

ITEM 3806-87 | 12¾Wx5Dx5¼H | 3 Jar

ITEM 3805-87 | 12¾Wx9Dx5¼H | 6 Jar



**L. COLD CONCEPT 1/6 PAN UNIT**

1/6 Pan Holders Include Cold Pucks.

1/6 Pans Included.

Dimensions: 11¾Wx7¾Dx6¼H.

ITEM 3837-3-60 | Bamboo

ITEM 3837-3-83 | Ashwood

ITEM 3837-3-99 | Madera

**M. COLD CONCEPT JAR UNIT**

Jars and Cold Pucks Included.

Dimensions: 15¾Wx5½Dx8¾H.

ITEM 3836-3-60 | Bamboo

ITEM 3836-3-83 | Ashwood

ITEM 3836-3-99 | Madera



Please visit [www.calmil.com/legal](http://www.calmil.com/legal) for a complete list of California Proposition 65 related items.

**CAL•MIL** | visit us online at: [www.calmil.com](http://www.calmil.com) | call toll-free 800-321-9069



# condiment & packet displays

A



B

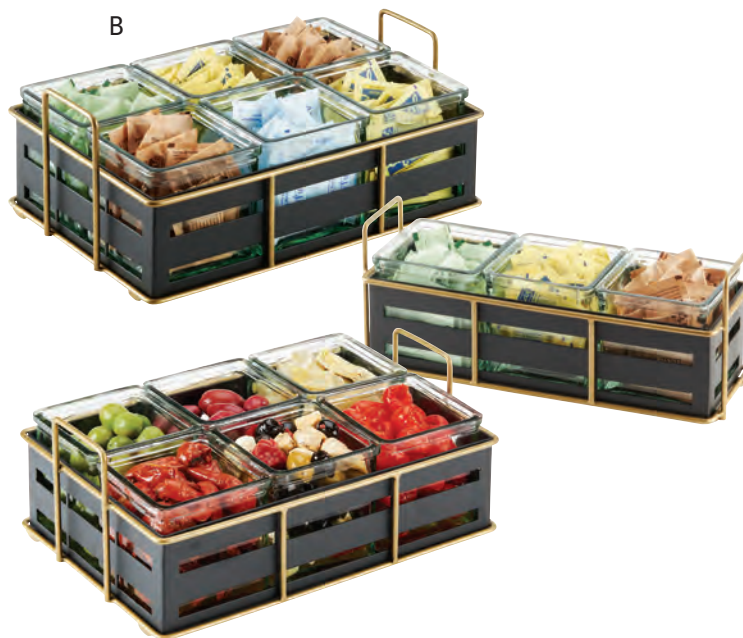

Your Custom  
Design Insert

C



A. GRANADA 9 JAR DISPLAY  
White Melamine Jars Included.

ITEM 4035-85 | 13Wx8Dx13¼H

B. EMPIRE JAR DISPLAYS **NEW**  
Glass Jars Included.

ITEM 22091-90 | 12½Wx4½Dx5¼H | 3 Jar

ITEM 22092-90 | 12½Wx8½Dx5¼H | 6 Jar

ITEM C4X4GLCN | Replacement Glass Jar

C. GRANADA JAR DISPLAYS  
Glass Jars Included.

ITEM 4031-3-85 | 13Wx5Dx4¼H

ITEM 4031-6-85 | 13Wx9¼Dx4¼H

ITEM C4X4GLCN | Replacement Glass Jar

D



D. PORTLAND JAR DISPLAYS  
Glass Jars Included.

Specify Color: Black (13), White (15) **NEW**.

ITEM 4101-3 | 12½Wx4½Dx5¼H

ITEM 4101-6 | 12½Wx8½Dx5H

ITEM C4X4GLCN | Replacement Glass Jar

Please visit [www.calmil.com/legal](http://www.calmil.com/legal) for a complete list of California Proposition 65 related items.



**E. SIERRA JAR DISPLAYS**

Glass Jars Included.

ITEM 3910-3-84 | 13Wx5Dx4¼H | w/ 3 Jars

ITEM 3910-6-84 | 12½Wx9Dx4½H | w/ 6 Jars

ITEM C4X4GLCN | Replacement Glass Jar



**F. MISSION JAR DISPLAYS**

Glass Jars Included.

Specify Color: Black (13), Platinum (39).

ITEM 1723 | 14Wx9Dx7H

ITEM C4X4GLCN | Replacement Glass Jar



**G. MADERA STAIR-STEP JAR DISPLAY**

Glass Jars Included.

ITEM 3612-4-99 | 5¼Wx14½Dx12½H

ITEM C4X4GLCN | Replacement Glass Jar



**H. ASHWOOD JAR DISPLAYS**

Glass Jars Included.

ITEM 3806-83 | 12¾Wx5Dx4½H | w/ 3 Jars

ITEM 3805-83 | 12¾Wx9Dx4½H | w/ 6 Jars

ITEM C4X4GLCN | Replacement Glass Jar



**I. MID-CENTURY JAR ORGANIZERS**

Glass Jars Included. Specify Color: Brass (46), Chrome (49).

ITEM 3714 | 13½Wx4½Dx4¾H | w/ 3 Jars

ITEM 3713 | 13½Wx8½Dx5H | w/ 6 Jars

ITEM C4X4GLCN | Replacement Glass Jar



**J. MADERA JAR DISPLAYS**

Glass Jars Included.

ITEM 3406-3 | 14Wx5½Dx3H

ITEM 3406-6 | 14Wx5½Dx6H

ITEM C4X4GLCN | Replacement Glass Jar



Please visit [www.calmil.com/legal](http://www.calmil.com/legal) for a complete list of California Proposition 65 related items.



# condiment & packet displays

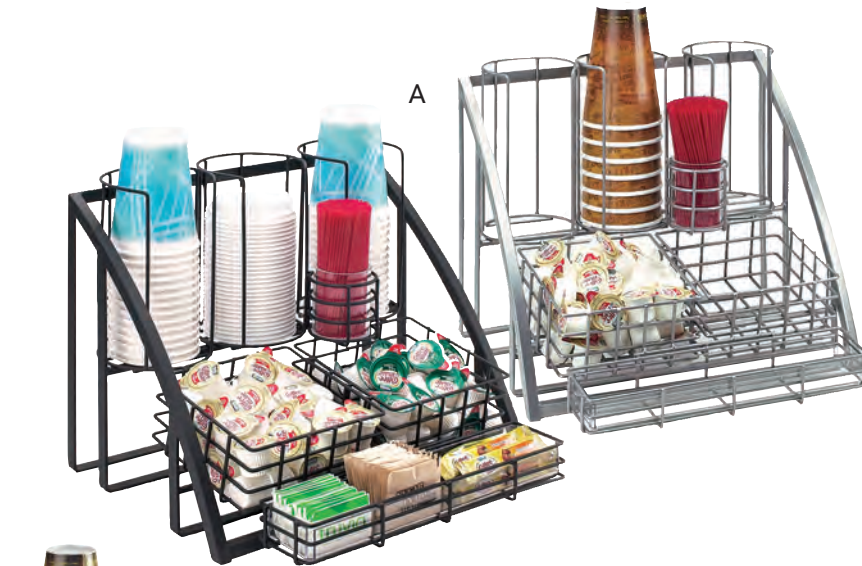

**A. MISSION  
CONDIMENT ORGANIZERS**  
Holds up to 3.75" Diameter Cups & Lids.  
Specify Color: Black (13), Platinum (39).  
ITEM 1715 | 15Wx14Dx12H



**B. IRON  
COFFEE CONDIMENT DISPLAY**  
Holds up to 3.75" Diameter Cups & Lids.  
ITEM 1453 | 12Wx10½Dx14½H



**C. SOHO CONDIMENT ORGANIZERS**  
Holds up to 3.75" Diameter Cups & Lids.  
Includes Acrylic Insert for Stir Sticks and  
Packets.  
Specify Color: Black (13), Silver (74).  
ITEM 1594 | 15¾Wx11¾Dx12H



**D. IRON PACKET ORGANIZER**  
Removable Frost Inserts.  
ITEM 1252 | 8½Wx6¾Dx4H



**E. PACKET AND STRAW ORGANIZER**  
Bamboo (60), Midnight Bamboo (96),  
Madera (99).  
ITEM 796-60 | 9Wx6¼Dx4½H  
ITEM 796-96 | 9Wx6¼Dx4½H  
ITEM 796-99 | 9Wx6¼Dx4½H

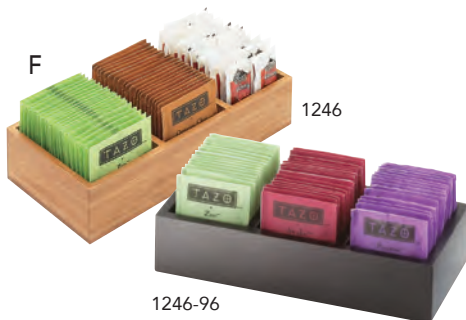

**F. BAMBOO/MIDNIGHT BAMBOO  
PACKET ORGANIZERS**  
ITEM 1246 | 9½Wx4½Dx2¼H | Bamboo  
ITEM 1246-96 | 9½Wx4½Dx2¼H | Midnight



**G. SQUARED PACKET ORGANIZER**  
Stainless Steel (55).  
ITEM 1611-55 | 9½Wx4½Dx2H



**H. LUXE THREE COMPARTMENT  
CONDIMENT ORGANIZER**  
Stainless Steel (55).  
ITEM 3014-55 | 9¼Wx4½Dx2½H

Please visit [www.calmil.com/legal](http://www.calmil.com/legal) for a complete list of California Proposition 65 related items.

**I. CINDERWOOD  
CONDIMENT DISPLAY**

ITEM 3801-87 | 13Wx13½Dx6¼H



**J. CINDERWOOD MULTI-SECTION ORGANIZER**

Plastic Liner Removable For Cleaning.

ITEM 3809-87 | 12Wx12Dx6H



**K. MID-CENTURY  
CONDIMENT ORGANIZERS**

Plastic Liner Removable For Cleaning.  
Specify Color: Brass (46), Chrome (49).

ITEM 3707 | 12Wx12Dx4½H



**L. CLASSIC ADJUSTABLE  
CONDIMENT ORGANIZER**

Dividers are Adjustable.

ITEM 1260 | 12Wx12Dx5½H



**M. MULTI-SECTION  
CONDIMENT ORGANIZERS**

ITEM 1714-60 | 12Wx12Dx5½H | Bamboo

ITEM 1714-96 | 12Wx12Dx5½H | Midnight Bamboo

ITEM 1714-99 | 12Wx12Dx5½H | Rustic Pine



**N. SQUARED CONDIMENT  
ORGANIZERS**

Plastic Liner Removable For Cleaning.  
Black (13), Stainless Steel (55).

ITEM 1616-13 | 12Wx12Dx5¼H

ITEM 1616-55 | 12Wx12Dx5¼H



**O. ASHWOOD CONDIMENT DISPLAY**

ITEM 3801-83 | 13Wx13½Dx6¼H



**P. ASHWOOD MULTI-SECTION  
CONDIMENT ORGANIZER**

Plastic Liner Removable For Cleaning.

ITEM 3809-83 | 12Wx12Dx6H



**Q. LUXE MULTI-SECTION  
CONDIMENT ORGANIZER**

Plastic Liner Removable For Cleaning.  
Stainless Steel Trim (55).

ITEM 3009-55 | 12¼Wx12¼Dx6½H



Please visit [www.calmil.com/legal](http://www.calmil.com/legal) for a complete list of California Proposition 65 related items.



# condiment & packet displays



## A. STAIR-STEP 5X5 JAR DISPLAY

Includes 4-5x5 Glass Jars.

ITEM 3604-13 | 10 $\frac{1}{4}$ Wx11Dx11 $\frac{1}{2}$ H

ITEM C5X5GLASS | Replacement Jar

## B. STAIR-STEP 4X4 JAR DISPLAY

Includes (3) 4x4 Glass Jars & Notched Lids.

ITEM 3605-13 | 14 $\frac{3}{4}$ Wx4 $\frac{1}{2}$ Dx13 $\frac{1}{2}$ H

ITEM C4X4GLCN | Replacement Jar

## C. COFFEE AND TEA CONDIMENT STAIR STEP

Includes (4) 4x8 Glass Jars.

ITEM 3338-13 | 9Wx18Dx17H

ITEM C4X8X4GLASS | Replacement 4x8 Jar

## D. STAIR-STEP CONDIMENT STATIONS

Includes (6) 4x4 Glass Jars,  
(3) 4x8 Glass Jars & (9) Notched Lids.

ITEM 3603-13 | 16Wx14 $\frac{3}{4}$ Dx13 $\frac{1}{2}$ H

ITEM C4X4GLCN | Replacement 4x4 Jar

ITEM C4X8X4GLASS | Replacement 4x8 Jar

## E. CLASSIC TRI-BOWL COFFEE ORGANIZER

ITEM 1092 | 18Wx11Dx9H

## F. CONDIMENT STATION

Divider is Removable to Create  
More Capacity.

Dimensions: 5 $\frac{1}{2}$ Wx13 $\frac{1}{4}$ Dx14 $\frac{1}{2}$ H.

ITEM 2052 | Classic Black

ITEM 2052-60 | Bamboo

ITEM 2052-99 | Rustic Pine

Please visit [www.calmil.com/legal](http://www.calmil.com/legal) for a complete list of California Proposition 65 related items.



**G. BAMBOO 3 TIER  
CONDIMENT DISPLAY**

ITEM 2053-60 | 7Wx5Dx16H  
ITEM 2054-60 | 10¼Wx6¾Dx16H



**H. ASHWOOD 3 TIER  
CONDIMENT DISPLAY**

ITEM 2053-83 | 5½Wx6½Dx15½H  
ITEM 2054-83 | 10½Wx6½Dx15½H



**I. CLEAR/WHITE  
CONDIMENT DISPLAYS**

ITEM 2053-15 | 5¼Wx6¾Dx16H  
ITEM 2054-15 | 10Wx6¾Dx16H



**J. CLASSIC 3 TIER  
CONDIMENT DISPLAYS**

ITEM 2053 | 5¼Wx6¾Dx16H  
ITEM 2054 | 10¼Wx6¾Dx16H

Please visit [www.calmil.com/legal](http://www.calmil.com/legal) for a complete list of California Proposition 65 related items.

**CAL•MIL** | visit us online at: [www.calmil.com](http://www.calmil.com) | call toll-free 800-321-9069



# condiment & packet displays



**A. CLASSIC COFFEE  
CONDIMENT DISPLAY**

ITEM 1261 | 6½Wx12Dx20½H

**B. HIGH CAPACITY  
PACKET DISPLAY**

ITEM 866 | 18½Wx16½Dx16H

**C. CLASSIC COFFEE  
CONDIMENT DISPLAY**

ITEM 1423 | 5¼Wx6¾Dx21H

**D. CLASSIC  
CONDIMENT ORGANIZER**

Has 2 Slots for Standard Napkin  
Dispensers (Not Included).

ITEM 2044 | 16Wx19¼Dx16¾H

**E. CLASSIC  
CONDIMENT ORGANIZER**

Has Slot for Standard Napkin  
Dispenser (Not Included).  
Holds Up to 3.75" Diameter  
Cups or Lids.

ITEM 2042 | 10Wx17¼Dx14¾H

**F. BULK CONDIMENT STATION**

Holds up to 3.75" Diameter  
Cups & Lids.

ITEM 3577 | 9¼Wx16¼Dx13H

Please visit [www.calmil.com/legal](http://www.calmil.com/legal) for a complete list of California Proposition 65 related items.



**G. 2 LEVEL CONDIMENT DISPLAY**

ITEM 3690-13 | 13Wx9¼Dx11¼H



**H. CLASSIC CONDIMENT STATION**  
Holds Up to 3.75" Diameter Cups or Lids.

ITEM 3664-13 | 14Wx11Dx6½H



**I. CLASSIC MENU/CONDIMENT HOLDER**

ITEM 3729-13 | 7½Wx12Dx5H



**J. CLASSIC CONDIMENT ORGANIZER**  
Holds Up to 3.75" Diameter Cups or Lids.

ITEM 2047 | 14Wx22½Dx20¼H



**K. IRON CONDIMENT DISPLAY**

Includes 3 Removable Bins.

ITEM 841 | 14Wx9Dx7H

**L. 9 SECTION CLASSIC ORGANIZER**

ITEM 3663-13 | 12½Wx12½Dx2H



**M. CLASSIC COFFEE CONDIMENT ORGANIZER**

ITEM 1259 | 8Wx12Dx4H



**N. CLASSIC CONDIMENT ORGANIZER**  
Dividers are Adjustable.

ITEM 2040 | 12Wx8½Dx4¼H





# condiment & packet displays



## A. BAMBOO/MIDNIGHT BAMBOO CONDIMENT STATION

Each 298 Sold Separately.  
Specify Color: Bamboo (60),  
Midnight Bamboo (96).

ITEM 2019 | 15Wx14½Dx9¼H

ITEM 298 | 4½Wx4½Dx8H | 3 Shown

## B. WIRE MELAMINE JAR DISPLAY

White Melamine Jars Included.  
Specify Color: Black (13), White (15) **NEW**

ITEM 22012 | 15½Wx4½Dx6½H

ITEM C1432BODY | Replacement Jar

ITEM C1432BODYC | Replacement Jar-Write On



## C. CLASSIC COFFEE CONDIMENT ORGANIZER

Counter Top or Wall Mount.  
White Melamine Jars and Hardware Not Included.

ITEM 786 | 12Wx8Dx9¼H

ITEM C1432BODY | White Melamine Jar

## D. CLASSIC CONDIMENT ORGANIZER

ITEM 925 | 8½Wx4Dx12H

## E. CLASSIC 3 STEP BOTTLE RISER

Cutouts are 4½x4½.

ITEM 3665-13 | 4½Wx14¼Dx6H

## F. BAMBOO CONDIMENT STATION

Stand Only.  
Cocks and Jars Sold Separately.

ITEM 3638-60 | 14½Wx13Dx12¼H

### OPTIONAL JARS & CROCKS

ITEM 1950-16-13 | Round Black Melamine Crock

ITEM 1950-16-15 | Round White Melamine Crock

ITEM C4X4GLCN | Square Glass Jar

ITEM C4X4-60 | Square Bamboo Bin



Please visit [www.calmil.com/legal](http://www.calmil.com/legal) for a complete list of California Proposition 65 related items.



**G. 4 BIN CONDIMENT HOLDER**

ITEM 3643-4 | 8¼Wx21¼Dx12½H



**H. 10 BIN CONDIMENT HOLDER**

ITEM 3643-10 | 21Wx12Dx12H



**I. REMOVABLE COMPARTMENT ORGANIZERS**

Black (13), Bamboo (60).

ITEM 3569-6-13 | 13¼Wx7Dx23¼H

ITEM 3569-6-60 | 13¼Wx7Dx23¼H



**J. MIDNIGHT BAMBOO SINGLE AIRPOT STAND WITH PACKET DRAWER**

Drip Tray Included. Airpot Not Included. Features Drawer for Packets & Stir Sticks.

ITEM 1051-1-96 | 8¼Wx12¾Dx6¼H



**K. MADERA AIRPOT STAND**

Drip Tray Included. Airpot Not Included. Features Drawer for Packets & Stir Sticks.

ITEM 3623-99 | 8Wx13Dx11¼H



Please visit [www.calmil.com/legal](http://www.calmil.com/legal) for a complete list of California Proposition 65 related items.



# flatware & condiment displays



A

## A. FLOORSTANDING BULK CONDIMENT UNIT

Base, Cylinders, and Cylinder Display Sold Separately.

### FRAME

ITEM 2003-13 | 21½Wx24Dx36H | Black

ITEM 2003-99 | 21½Wx24Dx36H | Madera

### CYLINDER HOLDER

ITEM 3423-16-96 | 19¾Wx18½Dx18½H | Black

ITEM 3423-16-99 | 19¾Wx18½Dx18½H | Madera



Madera (99)



B

C

## C. GLACIER TEA CENTER DISPLAY

ITEM 1235-TEA | 7½Wx14½Dx18H

## B. 3 TIER BIN DISPLAYS

Inserts are Included.

### BLACK FRAME

ITEM 1235-13-43 | 5¼Wx14Dx18H | Faux Glass Inserts

ITEM 1235-13-60 | 5¼Wx14Dx18H | Bamboo Inserts

ITEM 1235-13-96 | 5¼Wx14Dx18H | Midnight Bamboo Inserts

### PLATINUM FRAME

ITEM 1235-39-43 | 5¼Wx14Dx18H | Faux Glass Inserts

ITEM 1235-39-60 | 5¼Wx14Dx18H | Bamboo Inserts

## D. SILVER FLOOR FLATWARE & TRAY DISPLAY

Light Assembly Required.  
Cylinders Not Included.  
12" x 20" Trays are Not Included.

ITEM 2002-74\* | 20¾Wx24Dx50¼H

\*Ships by Truck Only



D

Please visit [www.calmil.com/legal](http://www.calmil.com/legal) for a complete list of California Proposition 65 related items.

**E. IRON CYLINDER DISPLAYS**

Cylinders Sold Separately.  
Specify Frame Color: Black (13),  
Platinum (39).

ITEM 1025-3 | 4¾Wx8Dx20H

ITEM 1025-6 | 9½Wx8Dx20H



**F. IRON SINGLE RING CYLINDER DISPLAY**

Cylinder Included.  
Cylinder Style: Perforated (39), (Solid).  
Frame Colors: Black (13), Platinum (39).

ITEM 1226-13-PERF | 6Wx6Dx6H

ITEM 1226-13-SOLID | 6Wx6Dx6H

ITEM 1226-39-PERF | 6Wx6Dx6H

ITEM 1226-39-SOLID | 6Wx6Dx6H

**G. EMPIRE CYLINDER DISPLAY NEW**

Cylinders Sold Separately.

ITEM 22086-90 | 7Wx7¼Dx18½H



**H. OPTIONAL CYLINDERS**

Available in Six Colors.  
Stainless Steel Style: Perforated (39), (SOLID).  
Colored Melamine: Black (13), White (15),  
Butter Yellow (61), Terra Cotta (62), Sage (63),  
Cranberry (64). Extra Deep: White (8-15).

ITEM 1017-39 | 4½DIAx5½H

ITEM 1017-SOLID | 4½DIAx5½H

ITEM 1017 | 4½DIAx5½H

ITEM 1017-8-15 | 4½DIAx8H | Extra Deep



**I. MISSION VERTICAL & SLOPED DISPLAYS**

Will Hold Solid, Perforated S/S,  
or Melamine Cylinders  
(Sold Separately).  
Frame Colors: Black (13),  
Platinum (39).

ITEM 1746-3 | 7Wx13Dx10¼H | Vertical

ITEM 1747-3 | 7Wx13Dx13H | Angled

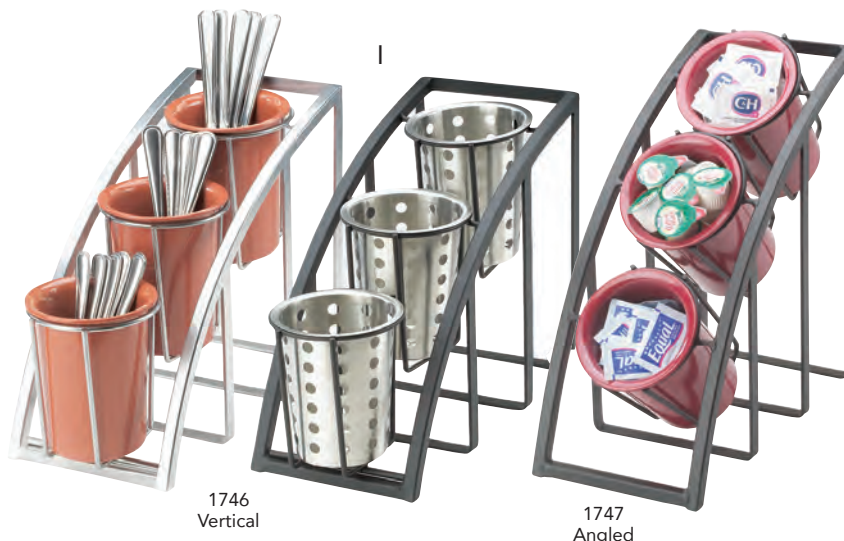

Please visit [www.calmil.com/legal](http://www.calmil.com/legal) for a complete list of California Proposition 65 related items.



# flatware & condiment displays



**A. ONE BY ONE METAL CYLINDER DISPLAY**  
Cylinders Sold Separately.  
Specify Color: Black (13), Silver (74).  
ITEM 1134 | 7½Wx6½Dx17½H

**B. IRON CONDIMENT DISPLAY**  
Includes 3 Removable Bins.  
ITEM 1709 | 6½Wx12Dx20½H

**C. SOHO CYLINDER DISPLAY**  
Cylinders Sold Separately.  
Specify Color: Black (13), Silver (74).  
ITEM 1583 | 8¾Wx8½Dx21H



**D. SQUARED VERTICAL CYLINDER DISPLAYS**  
Cylinders Sold Separately.  
Stainless Steel (55).  
ITEM 1605-55 | 5Wx8Dx20½H



**OPTIONAL CYLINDERS**  
Available in Six Colors.  
Stainless Steel Style: Perforated (39), (SOLID).  
Colored Melamine: Black (13), White (15),  
Butter Yellow (61), Terra Cotta (62), Sage (63),  
Cranberry (64). Extra Deep: White (8-15).

ITEM 1017-39 | 4½DIAx5½H

ITEM 1017-SOLID | 4½DIAx5½H

ITEM 1017 | 4½DIAx5½H

ITEM 1017-8-15 | 4½DIAx8H | Extra Deep



**E. SQUARED STAINLESS CYLINDER STAND**  
Cylinders Sold Separately.  
ITEM 1608-55 | 16Wx5¼Dx6H



**F. REVOLVING CYLINDER STAND**  
Cylinders Sold Separately.  
ITEM 1227-13 | 12Wx12Dx15¼H

Please visit [www.calmil.com/legal](http://www.calmil.com/legal) for a complete list of California Proposition 65 related items.



G



**G. MID-CENTURY  
CONDIMENT DISPLAYS**

Cylinders Sold Separately.  
Specify Color: Brass (46), Chrome (49).

ITEM 3715 | 6½Wx6½Dx19½H



H



**H. MADERA VERTICAL  
CYLINDER DISPLAY**

Cylinders Sold Separately.

ITEM 3411-99 | 7¼Wx7¾Dx20½H

**I. WRITE-ON LABEL  
FOR CYLINDER HOLDERS**

Each Label Sold Separately.

ITEM 22047 | 2¾Wx¾Dx1¼H



J



**J. GRANADA CYLINDER DISPLAY**

Melamine Cylinders Sold Separately.

ITEM 4019-85 | 7¼Wx6½Dx18¼H

**K. FLAT CYLINDER DISPLAYS**

Cylinders Sold Separately.  
Specify Color: Bamboo (60),  
Midnight Bamboo (96).

ITEM 1425-3 | 6Wx5½Dx16H | 3 Cylinder

ITEM 1425-6 | 6Wx11Dx16H | 6 Cylinder



K



**L. FLATWARE/CONDIMENT  
ORGANIZERS**

Plastic Liner Removable For Cleaning.

ITEM 3613-3-99 | 13¾Wx10Dx5¼H | Madera

ITEM 3802-83 | 13¾Wx10Dx6H | Ashwood

ITEM 3802-87 | 13¾Wx10Dx6H | Cinderwood



3802-83



3613-3-99



3802-87

Please visit [www.calmil.com/legal](http://www.calmil.com/legal) for a complete list of California Proposition 65 related items.



# flatware & condiment displays



**A. SIERRA CYLINDER DISPLAY**  
Cylinders Sold Separately.

ITEM 3912-84 | 6¾Wx6¾Dx19½H

**B. ECO MODERN  
CYLINDER DISPLAYS**  
Cylinders Sold Separately.

ITEM 1283 | 6½Wx8Dx17H | Bamboo  
ITEM 1283-15 | 6½Wx8Dx17H | White

**C. URBAN CYLINDER DISPLAY**  
Cylinders Sold Separately.  
Stainless Steel (55).

ITEM 3411-55 | 6¾Wx7½Dx20¼H

**D. LUXE VERTICAL  
CYLINDER DISPLAY**  
Cylinders Sold Separately.  
Stainless Steel Trim (55).

ITEM 3010-55 | 6¾Wx7½Dx20¼H

**E. MADERA ORGANIZER**  
Cylinders Sold Separately.

ITEM 3423-3-99 | 6¼Wx14½Dx15H

**F. FAUX STAINLESS ORGANIZER**  
Cylinders Sold Separately.  
Faux Brushed Stainless Steel ABS.

ITEM 1232 | 6Wx12Dx15½H

Please visit [www.calmil.com/legal](http://www.calmil.com/legal) for a complete list of California Proposition 65 related items.

flatware & condiment displays



**G. CLASSIC CYLINDER DISPLAY**

Cylinders Sold Separately.

ITEM 2049 | 11½Wx15¾Dx15¾H



**H. CLASSIC FLATWARE DISPLAY**

Cylinders Sold Separately.

Made with Durable ABS.

ITEM 1016-3 | 5½Wx8Dx20H | 3 Cylinder

ITEM 1016-6 | 11Wx8Dx20H | 6 Cylinder



**I. MONTEREY FLATWARE DISPLAY **NEW****

Includes Stainless Steel Flatware Holders.

ITEM 22048-13 | 4½Wx7Dx21H

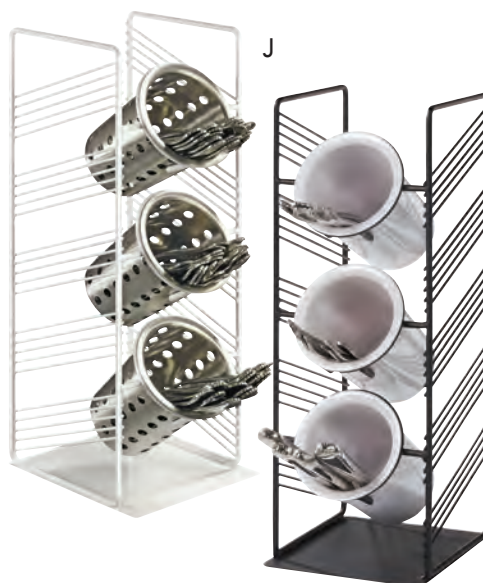

**J. PORTLAND CYLINDER DISPLAY**

Specify Color: Black (13), White (15) **NEW**.

ITEM 4105 | 6¾Wx7¾Dx19H

**K. BAMBOO/MIDNIGHT BAMBOO CYLINDER DISPLAY**

Cylinders Sold Separately. Specify Color: Bamboo (60), Midnight Bamboo (96).

ITEM 1016-3 | 6¼Wx9½Dx22¾H



**L. OPTIONAL CYLINDERS**

Available in Six Colors.

Stainless Steel Style: Perforated (39), (SOLID).

Colored Melamine: Black (13), White (15),

Butter Yellow (61), Terra Cotta (62), Sage (63),

Cranberry (64). Extra Deep: White (8-15).

ITEM 1017-39 | 4½DIAx5½H

ITEM 1017-SOLID | 4½DIAx5½H

ITEM 1017 | 4½DIAx5½H

ITEM 1017-8-15 | 4½DIAx8H | Extra Deep



Please visit [www.calmil.com/legal](http://www.calmil.com/legal) for a complete list of California Proposition 65 related items.

**CAL•MIL** | visit us online at: [www.calmil.com](http://www.calmil.com) | call toll-free 800-321-9069



# flatware displays



**A. GRANADA  
FLATWARE ORGANIZER**  
Plastic Insert Removable for Cleaning.  
ITEM 4032-85 | 9½Wx6¾Dx5½H



**B. ASHWOOD/CINDERWOOD  
FLATWARE ORGANIZER**  
Specify Color: Ashwood (83),  
Cinderwood (87).  
ITEM 3819 | 15Wx6Dx3H



**C. ASHWOOD/CINDERWOOD  
FLATWARE DISPLAY**  
Plastic Insert Removable  
for Cleaning.  
Specify Color: Ashwood (83),  
Cinderwood (87).  
ITEM 3811 | 9½Wx6¾Dx4¾H



**D. BAMBOO FLATWARE DISPLAYS**  
ITEM 1244 | 8¼Wx5½Dx4¾H | Bamboo  
ITEM 1244-96 | 8¼Wx5½Dx4¾H | Midnight



**E. SOHO FLATWARE DISPLAY**  
Specify Color: Black (13), Silver (74).  
ITEM 1544 | 4Wx4Dx4½H



**F. MID-CENTURY  
FLATWARE ORGANIZERS**  
Plastic Insert Removable for Cleaning.  
Specify Color: Brass (46), Chrome (49).  
ITEM 3700 | 9½Wx6½Dx5½H



**G. MADERA FLATWARE DISPLAY**  
Plastic Insert Removable for Cleaning.  
ITEM 3408-99 | 9Wx6Dx5¼H



**H. LUXE FLATWARE ORGANIZER**  
Stainless Steel Trim (55).  
ITEM 3015-55 | 8¼Wx5¾Dx6H



**I. URBAN FLATWARE ORGANIZER**  
Stainless Steel (55).  
ITEM 3408-55 | 9Wx6Dx5¼H



**J. STAINLESS STEEL  
FLATWARE DISPLAY**  
ITEM 3590-4-55 | 4½Wx4½Dx6H



**K. MARBLE  
FLATWARE HOLDER**  
ITEM 3630 | 5DIx7¼H



**L. CLASSIC FLATWARE  
NAPKIN DISPLAY**  
ITEM 910 | 8Wx8Dx5H

Please visit [www.calmil.com/legal](http://www.calmil.com/legal) for a complete list of California Proposition 65 related items.



**M. ASHWOOD/CINDERWOOD NAPKIN HOLDER**  
Specify Color: Ashwood (83), Cinderwood (87).  
ITEM 3810 | 4Wx8H | Napkin Size



**N. SQUARED STAINLESS NAPKIN HOLDER**  
Stainless Steel (55).  
ITEM 1606-55 | 4Wx8H | Napkin Size



**O. BAMBOO MIDNIGHT BAMBOO NAPKIN HOLDERS**  
Specify Color: Bamboo (60), Midnight Bamboo (96).  
ITEM 1234 | 4Wx8H | Napkin Size  
ITEM 1234-96 | 4Wx8H | Napkin Size



**P. ASHWOOD BAR NAPKIN HOLDER**  
ITEM 3309-83 | 5Wx5H | Napkin Size



**Q. IRON NAPKIN HOLDERS NEW**  
ITEM 4313-13 | 5Wx5H | Napkin Size  
ITEM 4314-13 | 4Wx8H | Napkin Size  
ITEM 22106-13 | 4Wx8H | Napkin Size



4314-13

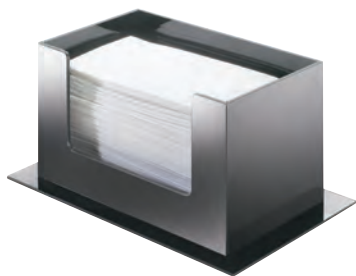

**R. CLASSIC PAPER TOWEL HOLDER**  
ITEM 952 | 4Wx8H | Napkin Size



**S. CLASSIC NAPKIN HOLDER**  
5" Napkin Size.  
Specify Color: Clear (12), Black (13).  
ITEM 635 | 5Wx5H | Napkin Size



**T. MID-CENTURY NAPKIN HOLDER**  
Specify Color: Brass (46), Chrome (49).  
ITEM 3718 | 4Wx8H | Napkin Size

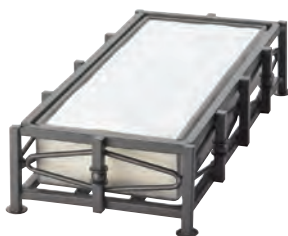

**U. IRON NAPKIN HOLDER**  
Removable Inner Body.  
ITEM 1253 | 4Wx8H | Napkin Size



**V. IRON NAPKIN HOLDER**  
ITEM 1243 | 5Wx5H | Napkin Size



**W. IRON PAPER TOWEL HOLDER**  
ITEM 808-13 | 4Wx8H | Napkin Size

Please visit [www.calmil.com/legal](http://www.calmil.com/legal) for a complete list of California Proposition 65 related items.



# cup & lid organizers



22111-99 22110-99



**A. MONTEREY REVOLVING CUP & LID ORGANIZER NEW**  
Stacking Madera Inserts Sold Separately.

ITEM 22109-15 | 8Wx8Dx17¼H

**OPTIONAL MADERA INSERTS**

ITEM 22110-99 | Condiment Base

ITEM 22111-99 | Stir Stick Holder

**D. SQUARED REVOLVING CUP & LID DISPENSER**

Holds Up to 3.75" Diameter Cups & Lids.  
Black (13), Stainless Steel (55).

ITEM 1615-13 | 8¼Wx8¼Dx18¼H

ITEM 1615-55 | 8¼Wx8¼Dx18¼H

**G. ASHWOOD REVOLVING CUP & LID ORGANIZER**

Holds Up to 3.75" Diameter Cups & Lids.

ITEM 3803-83 | 10Wx10Dx18¼H

**B. ONE BY ONE REVOLVING CUP & LID ORGANIZER**

Holds up to 3.75" Diameter Cups & Lids.  
Specify Color: Black (13), Silver (74).

ITEM 1133 | 10Wx10Dx15¼H

**E. SIERRA REVOLVING CUP & LID ORGANIZER**

Holds Up to 3.75" Diameter Cups & Lids.

ITEM 3904-84 | 9¼Wx9¼Dx18H

**H. IRON REVOLVING CUP & LID ORGANIZER**

Holds Up to 3.75" Diameter Cups & Lids.  
Specify Frame Color.

ITEM 369 | 8Wx8Dx17½H - Black

ITEM 369-39 | 8Wx8Dx17½H - Platinum

**C. MID-CENTURY REVOLVING CUP & LID ORGANIZER**

Holds Up to 3.75" Diameter Cups & Lids.  
Specify Color: Brass (46), Chrome (49).

ITEM 3709 | 8¼Wx8¼Dx18H

**F. CLASSIC REVOLVING CUP & LID ORGANIZER**

Holds Up to 3.75" Diameter Cups & Lids.

ITEM 378 | 8¼Wx8¼Dx18H

Please visit [www.calmil.com/legal](http://www.calmil.com/legal) for a complete list of California Proposition 65 related items.



**I. LUXE REVOLVING CUP & LID ORGANIZER**

Holds up to 3.75" Diameter Cups & Lids.  
Stainless Steel (55).

ITEM 3001-55 | 8¼Wx8¼Dx19H

**J. PORTLAND REVOLVING CUP & LID ORGANIZER**

Holds up to 3.75" Diameter Cups & Lids.  
Specify Color: Black (13), White (15) **NEW**.

ITEM 4104 | 8¼WX8¼DX17¼H

**K. CINDERWOOD REVOLVING CUP & LID ORGANIZER**

Holds Up to 3.75" Diameter Cups & Lids.

ITEM 3803-87 | 10Wx10Dx18¼H

**L. GRANADA REVOLVING CUP & LID ORGANIZER**

Holds up to 3.75" Diameter Cups & Lids.

ITEM 4017-85 | 8¼Wx8¼Dx17H

**M. BAMBOO REVOLVING CUP & LID ORGANIZER**

Holds up to 3.75" Diameter Cups & Lids.

ITEM 1468 | 9Wx9Dx18½H

**N. MIDNIGHT BAMBOO REVOLVING CUP & LID ORGANIZER**

Holds up to 3.75" Diameter Cups & Lids.

ITEM 378-96 | 8Wx8Dx18¼H

**O. BAMBOO REVOLVING CUP & LID ORGANIZER**

Holds up to 3.75" Diameter Cups & Lids.

ITEM 378-60 | 8Wx8Dx18¼H

**P. MADERA REVOLVING CUP & LID ORGANIZER**

Holds Up to 3.75" Diameter Cups & Lids.  
Rustic Pine (99).

ITEM 378-99 | 9Wx9Dx18½H

Please visit [www.calmil.com/legal](http://www.calmil.com/legal) for a complete list of California Proposition 65 related items.



# cup & lid organizers



**A. MISSION  
CONDIMENT ORGANIZER**

Holds up to 3.75" Diameter  
Cups & Lids.  
Specify Color: Black (13),  
Platinum (39).

ITEM 1715 | 15Wx14Dx12H

**B. SOHO  
CONDIMENT ORGANIZER**

Holds up to 3.75" Diameter  
Cups & Lids.  
Includes Acrylic Insert for Stir  
Sticks & Packets.  
Specify Color: Black (13), Silver (74).

ITEM 1594 | 15¾Wx11¼Dx12H

**C. IRON COFFEE  
CONDIMENT DISPLAY**

Holds up to 3.75" Diameter  
Cups & Lids.

ITEM 1453 | 12Wx10½Dx14½H



**D. CLASSIC  
CONDIMENT ORGANIZER**

Holds up to 3.75" Diameter  
Cups & Lids.

ITEM 2047 | 14Wx22½Dx20¼H



**E. CLASSIC CUP & LID ORGANIZER  
WITH COFFEE SLEEVE DISPENSER**

Coffee Sleeve Dispenser Sold Separately.  
Holds up to 3.75" Diameter Cups & Lids.

ITEM 2045 | 9¼Wx19¼Dx16¾H

ITEM 2050 | Coffee Sleeve Dispenser



**F. CLASSIC CUP, LID, &  
CONDIMENT ORGANIZER**

Has Slot for Standard Napkin Dispenser  
(Not Included). Dividers are Adjustable.  
Holds up to 3.75" Diameter Cups & Lids.

ITEM 2046 | 9¼Wx19¼Dx16½H

Please visit [www.calmil.com/legal](http://www.calmil.com/legal) for a complete list of California Proposition 65 related items.



298-96  
(3 Shown)



2019-96

298-60  
(3 Shown)

2019-60



**G. CONDIMENT STATIONS**

Pieces Sold Separately.

Specify Color: Bamboo (60),  
Midnight Bamboo (96),  
Madera (99).

ITEM 2019 | 15Wx14½Dx9¼H

ITEM 298 | 4½Wx4½Dx8H | 3 Shown

**H. BAMBOO SLANTED CUP, LID,  
& STRAW ORGANIZERS**

Holds up to 3.75" Diameter  
Cups & Lids.

ITEM 2048-3-60 | 4½Wx17Dx16¼H

ITEM 2048-4-60 | 4½Wx20Dx19½H

ITEM 2051-60 | 4¾Wx20Dx19½H



**I. URBAN REVOLVING  
CUP/LID ORGANIZER**

Holds up to 3.75" Diameter  
Cups & Lids.

ITEM 3393-55 | 7¾Wx7¾Dx18H



298-96

298-99

**J. NAPKIN/LID/CUP  
ORGANIZERS**

Bamboo (60), Midnight Bamboo (96),  
Reclaimed Wood (99).

ITEM 298-60 | 4½Wx4½Dx8H

ITEM 298-96 | 4½Wx4½Dx8H

ITEM 298-99 | 4½Wx4½Dx8½H



**K. CLASSIC CUP & LID  
ORGANIZER**

Holds up to 3.75" Diameter  
Cups & Lids.

ITEM 724 | 15½Wx5Dx12H



**L. CLASSIC CUP & LID ORGANIZER  
WITH STRAW/STIR STICK HOLDER**

Holds up to 3.75" Diameter  
Cups & Lids.

ITEM 2041 | 14½Wx8¾Dx10¼H

Please visit [www.calmil.com/legal](http://www.calmil.com/legal) for a complete list of California Proposition 65 related items.



# cup & lid organizers

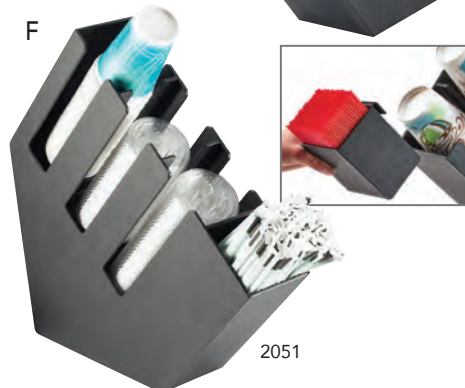
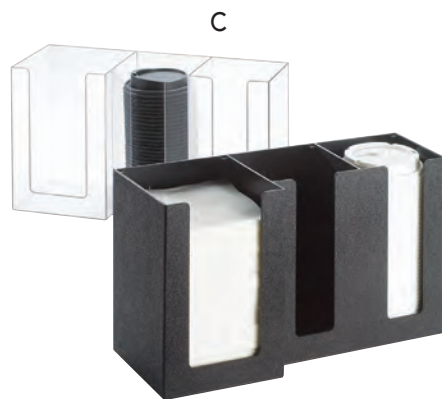
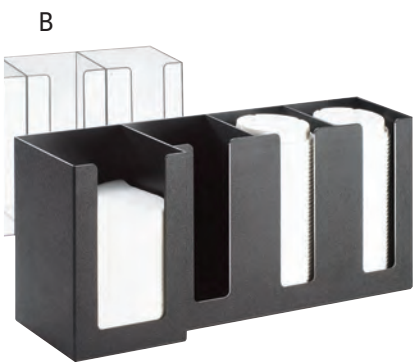

## A. CLASSIC NAPKIN/LID/ STRAW ORGANIZERS

Counter Top or Wall Mount.  
Hardware Not Included.  
Specify Color: Clear (12), Black (13).

ITEM 298 | 4½Wx4½Dx8H

ITEM 299 | 5¼Wx5¼Dx8H

ITEM 787 | 4¼Wx4¼Dx6H

## B. CLASSIC NAPKIN/ LID ORGANIZERS

Specify Color: Clear (12), Black (13).  
ITEM 376 | 17½Wx5Dx8H

## C. CLASSIC NAPKIN/LID ORGANIZER

Specify Color: Clear (12), Black (13).  
ITEM 375 | 13¼Wx5¼Dx8H

## D. RAMEKIN/LID ORGANIZERS

Countertop or Wall Mount.  
Hardware Not Included.

ITEM 278-2 | Up to 2½ Diameter

ITEM 278-3 | Up to 3 Diameter

ITEM 278-4 | Up to 4 Diameter

## E. CLASSIC CUP/LID ORGANIZER

Counter Top or Wall Mount.  
Hardware Not Included.

ITEM 1013 | 13½Wx7¼Dx11½H

## F. SLANTED CUP, LID, & STRAW ORGANIZERS

Holds up to 3.75" Diameter Cups & Lids.

ITEM 2048-3 | 4½Wx16¼Dx16¼H

ITEM 2048-4 | 4½Wx19¼Dx19¼H

ITEM 2051 | 4¾Wx20Dx20H

## OPTIONAL ACCESSORIES

ITEM 3573-13 | 3½Wx4H | Stir-Stick Holder

Please visit [www.calmil.com/legal](http://www.calmil.com/legal) for a complete list of California Proposition 65 related items.



**G. SIERRA CUP & LID HOLDER**  
 Holds up to 3.75" Diameter  
 Cups & Lids.  
 ITEM 3900-84 | 4¾Wx4¾Dx8¼H



**H. IRON CUP & LID ORGANIZER**  
 Holds up to 3.75" Diameter  
 Cups & Lids.  
 ITEM 1229 | 13Wx4½Dx8½H  
 ITEM 1233 | 22Wx6Dx9H



**I. 3 TIER CUP & LID ORGANIZER**  
 Holds up to 3.75" Diameter  
 Cups & Lids.  
 ITEM 1452 | 8Wx12Dx15H



**J. IRON CUP & LID HOLDER**  
 ITEM 1238 | 4¼Wx4¼Dx8¼H  
 ITEM 1239 | 4¼Wx4¼Dx8¼H



**K. IRON CUP & LID ORGANIZER**  
 ITEM 3036-13 | 4½Wx11½Dx11½H



**L. IRON BOWL/PLATE HOLDERS**  
 ITEM 1236 | 9½Wx9½Dx6½H  
 ITEM 1237 | 6½Wx6½Dx8H



**M. IRON REVOLVING LID/RAMEKIN ORGANIZER**  
 ITEM 1212-2 | Up to 2½ Diameter  
 ITEM 1212-3 | Up to 3 Diameter  
 ITEM 1212-4 | Up to 4 Diameter



**N. IRON LID/RAMEKIN ORGANIZER**  
 ITEM 1516-2-13 | Up to 2½ Diameter  
 ITEM 1516-3-13 | Up to 3 Diameter  
 ITEM 1516-4-13 | Up to 4 Diameter



**O. MID-CENTURY SINGLE CUP & LID ORGANIZERS**  
 Holds up to 3.75" Diameter  
 Cups & Lids.  
 Specify Color: Brass (46), Chrome (49).  
 ITEM 3716 | 5DIx8½H

Please visit [www.calmil.com/legal](http://www.calmil.com/legal) for a complete list of California Proposition 65 related items.



# signage displays



## A. ASHWOOD CARDHOLDERS

- ITEM 3825-23-83 | 3½Wx2H
- ITEM 3825-46-83 | 4Wx6H
- ITEM 3825-811-83 | 8½Wx11H

## B. WHITE CARDHOLDERS

- ITEM 3671-46-15 | 4Wx6H
- ITEM 3671-811-15 | 8½Wx11H

## C. MADERA CARDHOLDERS

- ITEM 3483-23-99 | 3½Wx2H
- ITEM 3483-46-99 | 4Wx6H
- ITEM 3483-811-99 | 8½Wx11H



## D. CLASSIC STANDARD TABLETOP CARDHOLDERS

- ITEM P406 | 4Wx7H
- ITEM 500 | 4½Wx3½H | RESERVED
- ITEM 521 | 4¼Wx5½H
- ITEM 523 | 4½Wx6½H
- ITEM 524 | 5½Wx8½H
- ITEM 526 | 8½Wx11H
- ITEM 532 | 4Wx6H
- ITEM 537 | 4Wx8H
- ITEM 538 | 5Wx7H
- ITEM 591 | 2¼Wx2¼H



## E. CINDERWOOD CARDHOLDERS

- ITEM 3825-23-87 | 3½Wx2H
- ITEM 3825-46-87 | 4Wx6H
- ITEM 3825-811-87 | 8½Wx11H

## F. MIDNIGHT BAMBOO U-FRAME CARDHOLDERS

- ITEM 1510-32-96 | 3½Wx2H
- ITEM 1510-46-96 | 4Wx6H
- ITEM 1510-811-96 | 8½Wx11H

Please visit [www.calmil.com/legal](http://www.calmil.com/legal) for a complete list of California Proposition 65 related items.



G

**G. LUXE SIGNAGE & MENU HOLDER**

Stainless Steel Trim (55).

ITEM 3016-811-55 | 8½Wx11H



H

**H. BAMBOO SIGNAGE**

ITEM 1510-32-60 | 3½Wx2H

ITEM 1510-411-60 | 4¼Wx11H

ITEM 1510-46-60 | 4Wx6H

ITEM 1510-811-60 | 8½Wx11H



I

**I. SIERRA CARDHOLDERS**

ITEM 3925-46-84 | 4Wx6H

ITEM 3925-811-84 | 8½Wx11H



J

**J. DELUXE CARDHOLDERS**

ITEM 650-17 | 4Wx6H

ITEM 653-17 | 5½Wx8½H

ITEM 695-17 | 8½Wx11H



K

**K. U-FRAME TABLETOP CARDHOLDERS**

ITEM 1510-32 | 3½Wx2H

ITEM 1510-46 | 4Wx6H

ITEM 1510-411 | 4¼Wx11H

ITEM 1510-811 | 8½Wx11H



L

**L. CLASSIC ACRYLIC ARCHED CARDHOLDERS**

ITEM 633 | 8½Wx11H

ITEM 654 | 4Wx6H



M

**M. IRON SIGNAGE**

ITEM 1262 | 3½Wx2H

ITEM 1264 | 8½Wx11H



N

**N. FORMA FRAME CARDHOLDERS**

ITEM 828 | 8½Wx11H

ITEM 830 | 3½Wx2H



O

**O. MENU BOARDS**

Specify Color: Black (13), Natural (14).

ITEM 2034-411 | 4Wx11H

ITEM 2034-57 | 5Wx7H

ITEM 2034-811 | 8½Wx11H

Please visit [www.calmil.com/legal](http://www.calmil.com/legal) for a complete list of California Proposition 65 related items.



# signage displays



A



B



C



D



E



F



G



H



I

## A. WHITE U-FRAME CARDHOLDERS

- ITEM 1510-32-15 | 3½Wx2H
- ITEM 1510-46-15 | 4Wx6H
- ITEM 1510-811-15 | 8½Wx11H

## B. CLEAR CARDHOLDERS

- ITEM 3567-46 | 4Wx6H
- ITEM 3567-811 | 8½Wx11H

## C. CLASSIC TABLETOP CARDHOLDERS

- ITEM 541 | 4Wx6H
- ITEM 542 | 4Wx7H

## D. CLASSIC EASEL TABLETOP CARDHOLDERS

- ITEM 509 | 3½Wx2H
- ITEM 513 | 8½Wx11H
- ITEM 515 | 5Wx7H
- ITEM 561 | 5½Wx3½H

## E. CLASSIC T-TYPE TABLETOP CARDHOLDERS

- ITEM 512 | 4Wx6H
- ITEM 570 | 5Wx7H

## F. CLASSIC BLACK TRIM CARDHOLDERS

- ITEM 534-13 | 4Wx6H
- ITEM 536-13 | 8½Wx11H

## G. CLASSIC UPRITE TABLETOP CARDHOLDERS

- ITEM 506 | 4Wx6H
- ITEM 580 | 5Wx7H
- ITEM 583 | 8½Wx11H

## H. BROCHURE HOLDERS

- ITEM 208 | 4Wx1½Dx8H
- ITEM 209 | 6Wx1½Dx8H
- ITEM 210 | 8½Wx1½Dx10H

## I. WALL MOUNT MENU RACK

- Mounting Hardware Not Included.
- ITEM 291 | 9¼Wx3Dx10H

Please visit [www.calmil.com/legal](http://www.calmil.com/legal) for a complete list of California Proposition 65 related items.



1153-15

1153-46

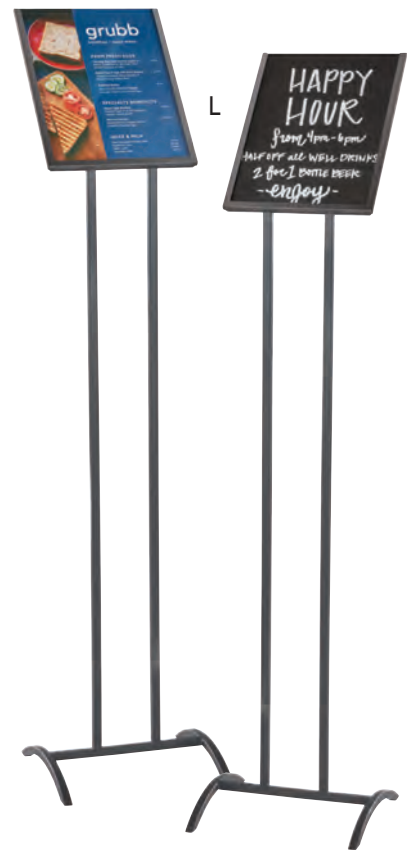

**J. ONE BY ONE  
MAGNETIC SIGN DISPLAYS**

Features a Metal Sign with Magnetic Front for Secure Display. Holds 8½x11 Card Size. Specify Color: Black (13), Silver (74).

ITEM 1153-15 | 8¾Wx8¾Dx15½H

**K. ONE BY ONE TALL  
MAGNETIC SIGN DISPLAYS**

Features a Metal Sign with Magnetic Front for Secure Display. Holds 8½x11 Card Size. Specify Color: Black (13), Silver (74).

ITEM 1153-46 | 8¾Wx8¾Dx46¼H

**L. METAL FRAME SIGN HOLDER**  
Includes Both Chalkboard and Sign Holder!

ITEM 4091-811-13 | 10Wx11Dx43½H

**M. WATER-RESISTANT  
WET FLOOR SIGN **NEW****

ITEM 22094 | 13Wx17Dx23H

**N. WET FLOOR SIGNS**

Double Sided.  
Westport (52), Bamboo (60).

ITEM 851-WET | 12Wx17½Dx20H - Westport

ITEM 852-52 | 12Wx17½Dx22H - Hinge Stop

ITEM 852-60 | 12Wx17½Dx22H - Hinge Stop



852-60

851-WET

**O. OUTDOOR WET FLOOR SIGN**

Double Sided.  
Constructed of Composite.

ITEM 3504 | 12Wx17½Dx22H

**P. STAINLESS STEEL  
WET FLOOR SIGN**

Double Sided.

ITEM 852-55 | 12Wx17½Dx22H

**Q. EXTRA STRONG  
WET FLOOR SIGN**

Double Sided.  
Great for Use Indoor or Outdoor.

ITEM 3506 | 11¾Wx17Dx23H



Please visit [www.calmil.com/legal](http://www.calmil.com/legal) for a complete list of California Proposition 65 related items.



# signage displays

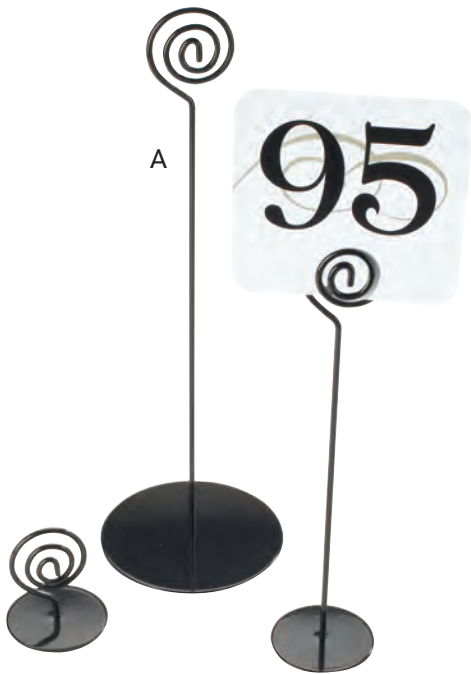

A



B

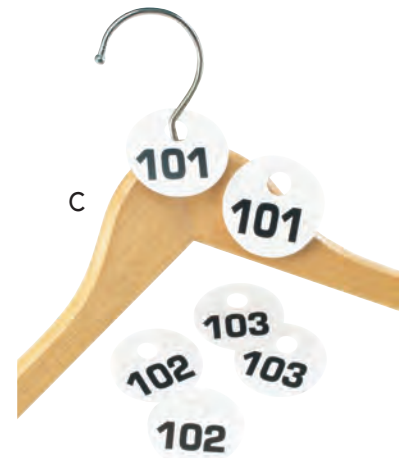

C



D



E

248-13



1543-60

F



## A. IRON NUMBER STAND

Numbers Sold Separately.

ITEM 661-2-13 | 2Wx2Dx2H

ITEM 661-9-13 | 2Wx2Dx9H

ITEM 661-12-13 | 4Wx4Dx12H

## B. NUMBER CARDS

Set of 50.

Dimensions: 4Wx¼Dx3¼H.

ITEM 671-1 | 1-50

## C. COAT CHECK TAGS

1½ Diameter Tag.

Set has 2 of Each Number.

ITEM 869 | 1-100

ITEM 869-1 | 101-200

ITEM 869-2 | 201-300

## D. SUGGESTION BOXES

5" Slot Size.

Complete with Locking Feature.

ITEM 388 | 12Wx3½Dx15H

ITEM 390 | 7Wx7Dx16H

## E. CARD HOLDERS

Holds Business Sized Cards.

Good for Chafer Signs or Table Numbers.

Black (13), Bamboo (60).

ITEM 248-13 | 2Wx1Dx2½H

ITEM 1543-60 | 2¼Wx¾Dx¾H

## F. WALL MOUNTED U-STYLE HOLDER

Mounting Hardware Not Included.

ITEM 214 | 8½Wx11H

ITEM 5835 | 11Wx8½H

Please visit [www.calmil.com/legal](http://www.calmil.com/legal) for a complete list of California Proposition 65 related items.



**G. CHALKBOARD BEVERAGE SIGNS**

Dimensions: 3Wx2Dx2H.

ITEM 3047 | WRITE-ON / BLANK

ITEM 3047-1 | COFFEE

ITEM 3047-2 | DECAF

ITEM 3047-3 | HOT WATER

ITEM 3047-4 | TEA



**H. URN CHAIN SIGNS**

Urn Chains: 4Wx¼Dx2H.

ITEM 618-1 | COFFEE

ITEM 618-2 | DECAF

ITEM 618-3 | HOT WATER



**I. BAMBOO BEVERAGE SIGNS**

Dimensions: 3Wx1Dx2H.

ITEM 606-1 | COFFEE

ITEM 606-2 | DECAF

ITEM 606-3 | HOT WATER

ITEM 606-4 | TEA



**J. BEVERAGE TENTS**

Dimensions: 3Wx1Dx1½H.

Specify Color: Silver (010) or Gold (011).

ITEM 228-1 | COFFEE

ITEM 228-2 | DECAF

ITEM 228-3 | HOT WATER

ITEM 228-5 | ICED TEA | N/A in Gold (011)

ITEM 228-8 | HALF & HALF | N/A in Gold (011)



# signage displays

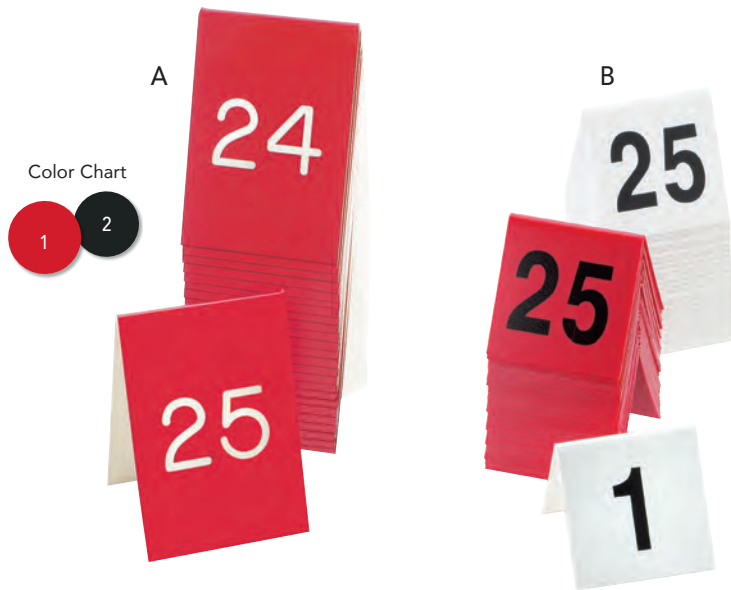

**A. ENGRAVED NUMBER TENT SETS**  
269 - 3Wx3H. 271 - 3½Wx5H.  
Specify Color: Red/White (1), Black/White (2).  
See Color Chart.

- ITEM 269A | 1-25
- ITEM 269B | 26-50
- ITEM 269C | 51-75
- ITEM 271A | 1-25
- ITEM 271B | 26-50
- ITEM 271C | 51-75

**ENGRAVED NUMBER TENT**  
Specify Color: Red/White (1), Black/White (2).  
See Color Chart. Specify Number and Color.

- ITEM 269 | 3Wx3H
- ITEM 271 | 3½Wx5H



**B. BREAK RESISTANT NUMBER TENTS**  
Numbered on Both Sides.  
Dimensions: 3Wx2Dx3H.

**WHITE**

- ITEM 227 | 1-25
- ITEM 227-1 | 26-50
- ITEM 227-2 | 51-75
- ITEM 227-3 | 76-100

**RED**

- ITEM 226 | 1-25
- ITEM 226-1 | 26-50
- ITEM 226-2 | 51-75
- ITEM 226-3 | 76-100

**C. BREAK RESISTANT NUMBER TENTS**  
Numbered on Both Sides. Sets Only.  
Dimensions: 3½Wx2Dx3H.

**WHITE**

- ITEM 234 | 1-25
- ITEM 234-1 | 26-50

**BLACK**

- ITEM 234-13 | 1-25
- ITEM 234-1-13 | 26-50



**D. BLACK VINYL TENTS**

Message Imprinted on Both Sides.

- ITEM 283 | 9¼Wx1Dx3H
- ITEM 285 | 5¾Wx1Dx2H

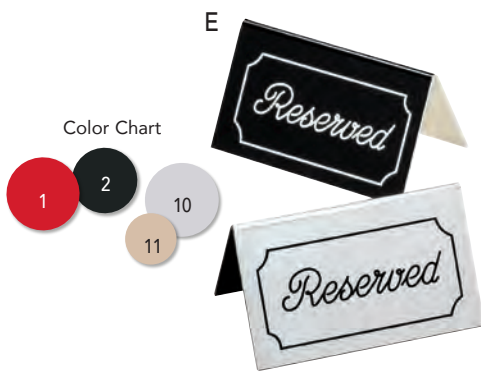

**E. ENGRAVED RESERVED TENTS**

Double-Sided. Specify Color: Red/White (1), Black/White (2), Silver/Black (10), Gold/Black (11).

- ITEM 273 | 5Wx1Dx3H



**F. BLACK BASE SIGNAGE**

Specify Color: Silver (10), Gold (11).

- ITEM 956 | 5Wx1Dx3H

Please visit [www.calmil.com/legal](http://www.calmil.com/legal) for a complete list of California Proposition 65 related items.

**G. MADERA CLIPBOARD MENU**

- ITEM 2036-32-99 | 3Wx2H
- ITEM 2036-46-99 | 4Wx6H
- ITEM 2036-811-99 | 8½Wx11H



**H. BAMBOO CLIPBOARD MENU**

- ITEM 2036-32-60 | 3Wx2H
- ITEM 2036-46-60 | 4Wx6H
- ITEM 2036-811-60 | 8½Wx11H



**I. MID-CENTURY CARDHOLDERS**

- ITEM 4012-78 | 1¾Wx1¾Dx1¼H
- ITEM 4013-78 | 1¾Wx1¾Dx1¼H
- ITEM 4014-78 | 3¼Wx3¼Dx1H

**J. HANGING S HOOK SIGNAGE**

- ITEM 4301 | 10Wx4Dx18½H



**K. CLASSIC TURNTABLE CARDHOLDERS**

- ITEM 507 | 4Wx6H
- ITEM 530 | 4Wx6H

**L. CLASSIC 3-WING TABLETOP CARDHOLDERS**

- ITEM 575 | 4Wx6H - Regular
- ITEM 576 | 4Wx6H - Footed



Please visit [www.calmil.com/legal](http://www.calmil.com/legal) for a complete list of California Proposition 65 related items.



# write on displays



A

## A. AZTEC WRITE-ON SIGNS

Includes Base.  
Specify Color: Black (13), White (15).  
ITEM 3344 | 3Wx2H - Write On Area

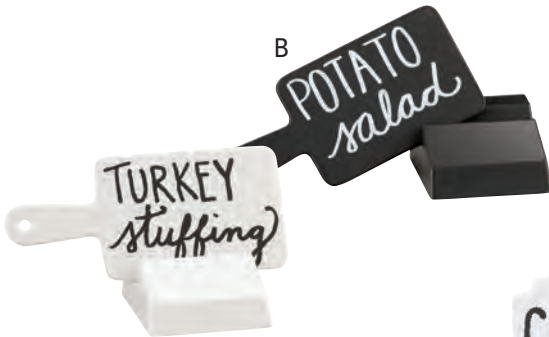

B

## B. PADDLE WRITE-ON SIGNS

Includes Base.  
Specify Color: Black (13), White (15).  
ITEM 3345 | 4½Wx2H - Write On Area | w/ Base



C

## C. CHALKBOARD BEVERAGE SIGN

ITEM 3047 | 3Wx2H - Write On Area



D

## D. BLACK STANDS FOR WRITE-ON

Write-On Signs Sold Separately.

ITEM 3346-5-13 | 5"H Stand - Write On Area

ITEM 3346-10-13 | 10"H Stand - Write On Area

## SIGNS

ITEM 3344-13SIGN | Black Aztec - Write On Area

ITEM 3344-15SIGN | White Aztec - Write On Area

ITEM 3345-13SIGN | Black Paddle - Write On Area

ITEM 3345-15SIGN | White Paddle - Write On Area



E

## E. CLASSIC WRITE-ON EASEL

ITEM 216-13 | 8½Wx11H

ITEM 950-13 | 5Wx7H

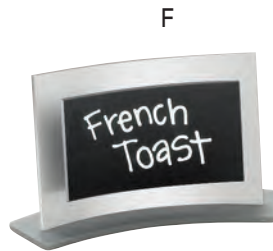

F

## F. WRITE-ON FORMA BOARD

ITEM 891 | 3Wx2½H - Write On Area



G

## G. BLACK AND WHITE PENS

ITEM 3061-13 | Black Wet-Erase

ITEM 3062-15 | White Chalkboard Pen



H

## H. WRITE-ON PENS

ITEM 240 | 5 Colored Pens | Set

Please visit [www.calmil.com/legal](http://www.calmil.com/legal) for a complete list of California Proposition 65 related items.

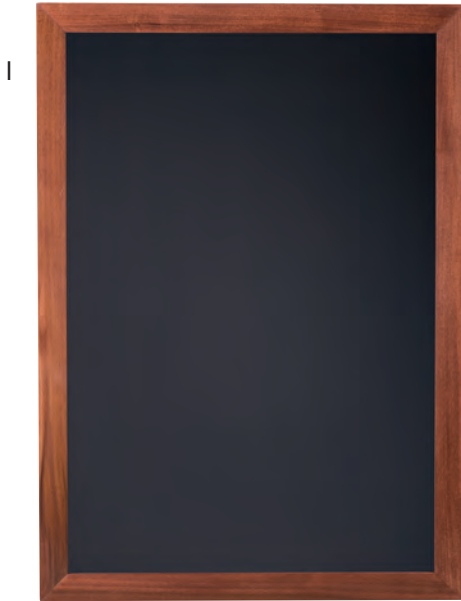

**I. LARGE CHALKBOARD SIGNS**  
ITEM 3348-2435 | 24Wx35H | Chalkboard Size



**J. MADERA CHALKBOARD SIGNS**  
ITEM 3489-23-99 | 3Wx2H | Chalkboard Size  
ITEM 3489-46-99 | 4Wx6H | Chalkboard Size  
ITEM 3489-811-99 | 8Wx11H | Chalkboard Size



**K. ASHWOOD CHALKBOARD SIGNS**  
ITEM 3818-23-83 | 3Wx2H | Chalkboard Size  
ITEM 3818-46-83 | 4Wx6H | Chalkboard Size  
ITEM 3818-811-83 | 8½Wx11H | Chalkboard Size



**L. CINDERWOOD CHALKBOARD SIGNS**  
ITEM 3818-23-87 | 3Wx2H | Chalkboard Size  
ITEM 3818-46-87 | 4Wx6H | Chalkboard Size  
ITEM 3818-811-87 | 8Wx11H | Chalkboard Size

**M. OPEN-FRAME CHALKBOARDS**  
ITEM 3049-32 | 3Wx2H | Chalkboard Size  
ITEM 3049-46 | 4Wx6H | Chalkboard Size

**N. WRITE-ON BEVERAGE SIGNS**  
Fits all Square Beverage Dispensers!  
ITEM 3059 | 5Wx3H | Chalkboard Size | Stainless Steel  
ITEM 3616-99 | 5Wx4H | Chalkboard Size | Rustic Pine  
ITEM 3062-15 | White Chalkboard Pen



3616-99

3059

Please visit [www.calmil.com/legal](http://www.calmil.com/legal) for a complete list of California Proposition 65 related items.



# chalkboard displays



A

B

C

D

E



## A. SIERRA CHALKBOARD SIGNS

ITEM 3919-43-84 | 4Wx3H | Chalkboard Size  
 ITEM 3919-46-84 | 4Wx6H | Chalkboard Size  
 ITEM 3919-811-84 | 8½Wx11H | Chalkboard Size

## B. MID-CENTURY EASELS

Specify Color: Brass (46), Chrome (49).  
 ITEM 3717-46 | 4Wx6H | Chalkboard Size  
 ITEM 3717-811 | 8½Wx11H | Chalkboard Size

## C. MADERA WRITE-ON TENT **NEW**

Write-On Area on Both Sides.  
 Collapsible for Easy Storage.  
 ITEM 22051-99 | 2Wx2¼Dx3H | Chalkboard Size

## D. CHALKBOARD WRITE-ON TENT

ITEM 3047 | 3Wx2H - Write On Area

## E. WHITE CHALKBOARD PEN

ITEM 3062-15 | White Chalkboard Pen

## F. CHALKBOARD BOWLS & COLD BOWLS

Cold Bowl Inserts Sold Separately.  
 Specify Color: White (15), Madera (99).

ITEM 3593-8 | 8Wx8Dx5H  
 ITEM 3593-10 | 10Wx10Dx5H  
 ITEM 3593-12 | 12Wx12Dx5H

## OPTIONAL COLD BOWL INSERTS

ITEM 3326-7-55 | Fits 3593-8  
 ITEM 3326-10-55 | Fits 3593-12

## G. CHALKBOARD CRATE HOUSINGS

Includes Clear Polycarbonate Bin for Ice Housings. Can be Used as Crates or Ice Housing.

ITEM 3354-6 | 7Wx7Dx8H  
 ITEM 3354-10 | 13Wx11Dx7H  
 ITEM 3354-12 | 13½Wx21½Dx7H

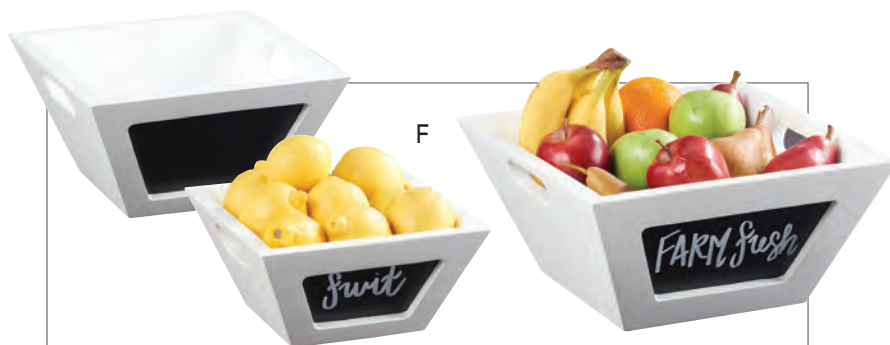

F

White Chalkboard Bowls



Madera Chalkboard Bowls



G

Please visit [www.calmil.com/legal](http://www.calmil.com/legal) for a complete list of California Proposition 65 related items.

**H. WRITE-ON BAGEL DISPLAY NEW**

Available in Madera (-99), White (-15).  
Bagel Sleeves Sold Separately.

ITEM 22062-99 | 15Wx16Dx4¼H

ITEM 22062-15 | 15Wx16Dx4¼H

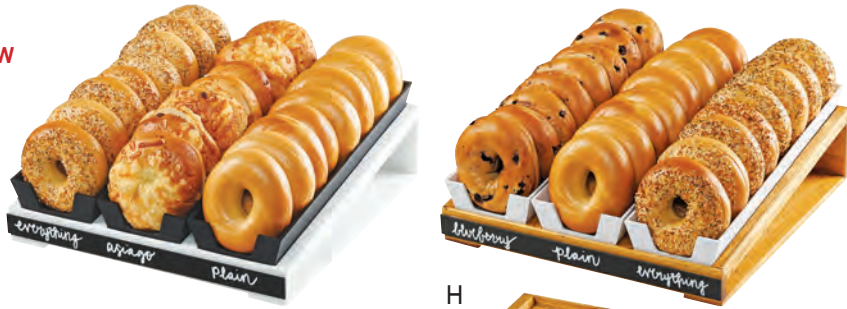

**I. BAGEL SLEEVES NEW**

Available in Black (-13), White (-15).

ITEM 22061-13 | 15¼Wx4¾Dx2H

ITEM 22061-15 | 15¼Wx4¾Dx2H



**J. ASHWOOD TASTER CADDY**

2.25" Cut Outs for Glasses.  
Glasses Not Included.

ITEM 3824 | 13Wx4Dx2¾H

ITEM 3062-15 | White Chalkboard Pen



**K. WRITE-ON TASTING BOARDS**

2.25" Cut Outs for Glasses.  
Customization is Always Possible.  
Glasses Not Included.

ITEM 2063 | 12Wx6Dx1½H - Rustic Pine

ITEM 2064 | 12Wx6Dx1½H - Crushed Bamboo

ITEM 3062-15 | White Chalkboard Pen



**L. MADERA JAR DISPLAY**

Includes 3 Glass Jars.  
Chalkboard Stick-On's Sold Separately.

ITEM 3406-3 | 14Wx5½Dx3H

ITEM 3406-6 | 14Wx5½Dx6H

ITEM 3062-15 | White Chalkboard Pen

**OPTIONAL CHALKBOARD STICK-ONS**

ITEM 3057 | 3Wx2D



**M. MADERA WRITE-ON TASTING CRATES**

Customization is Always Possible.  
2.25" Cut Outs for Glasses.  
Glasses Not Included.

ITEM 3058 | 10¼Wx3¼Dx2¾H

ITEM 3062-15 | White Chalkboard Pen



Please visit [www.calmil.com/legal](http://www.calmil.com/legal) for a complete list of California Proposition 65 related items.



# bar & mixology displays



## A. GLASS INFUSION DISPENSERS

ITEM 1733-2 | 7½Wx7½Dx12H | 2 Gallon

ITEM 1733-3 | 8Wx8Dx19H | 3 Gallon

ITEM 1745 | 10Wx11Dx17¼H | 3 Gallon

ITEM 1748-2 | 8½Wx13¾Dx13¾H | 2 Gallon

ITEM 1748-3 | 8½Wx13¾Dx17½H | 3 Gallon

## PULP FILTER FOR DISPENSERS

ITEM 148-FILTER | 2¼Wx2¼H



Does Not  
Work With  
Ice or Infusion  
Chambers



Please visit [www.calmil.com/legal](http://www.calmil.com/legal) for a complete list of California Proposition 65 related items.



**B. OPTIONAL JARS & LIDS**

**JARS**

ITEM C4X4GLCN | 4Wx4Dx4H | Glass

ITEM 22055-4 | 4Wx4Dx4H | Polycarbonate

ITEM 22107-55 | 4Wx4Dx4H | Stainless Steel **NEW**

**LIDS**

ITEM 1807 | Solid | Metal Hinge

ITEM 1807-N | Notched | Metal Hinge

ITEM 1811 | Solid | Soft Hinge

ITEM 1811-N | Notched | Soft Hinge



**E. IRON 3 GLASS JAR DISPLAY**  
Glass Jars Included.

ITEM 1805-4-13 | 12Wx4Dx5H



**H. IRON 3 TIER GLASS JAR DISPLAY**  
Glass Jars Included.

ITEM 1804-13 | 12½Wx11Dx13H



**C. ALUMINUM JAR RISERS**

Glass Jars Included.

ITEM 1560-2 | 12Wx4½Dx2H

ITEM 1560-4 | 12Wx4½Dx4H



1806-7-13



1806-5-39

**F. IRON HIGH RISE ICED GLASS JAR DISPLAY**

Includes Glass Jars.

Specify Color: Black (13), Platinum (39).

ITEM 1806-5 | 13½Wx5½Dx7H

ITEM 1806-7 | 13½Wx5½Dx9H



1809-39

**I. IRON 6 GLASS JAR DISPLAY**

Specify Color: Black (13), Platinum (39). Glass Jars Included.

ITEM 1809 | 14Wx9Dx7H



**D. MADERA JAR DISPLAYS**

Includes 3 Glass Jars.

Chalkboard Stick-On's Sold Separately.

ITEM 3406-3 | 14Wx5½Dx3H

ITEM 3406-6 | 14Wx5½Dx6H

**OPTIONAL CHALKBOARD STICK-ON AND PENS**

ITEM 3057 | 3Wx2D

ITEM 3062-15 | White Chalkboard Pen



1803-4-13

**G. IRON 3 STEP GLASS JAR DISPLAY**

Glass Jars Included.

Specify Color: Black (13), Chrome (49).

ITEM 1803-4-13 | 4Wx12Dx10½H

ITEM 1803-4-49 | 4Wx12Dx10½H



**J. MADERA SINGLE JAR RISERS**

Includes Glass Jar.

ITEM 3427-3-99 | 4½Wx4½Dx3H

ITEM 3427-5-99 | 4½Wx4½Dx5H

ITEM 3427-7-99 | 4½Wx4½Dx7H

Please visit [www.calmil.com/legal](http://www.calmil.com/legal) for a complete list of California Proposition 65 related items.



# bar & mixology displays



Place Pucks in Freezer  
for a Minimum of 6 Hours.  
Keeps Contents Cold  
for Hours!

Cooling Puck for Jars  
(Sold Separately)

## A. 3 TIER CHILLED MIXOLOGY DISPLAYS

Complete Set with Cold Pucks.

16 OZ. JARS (14Wx11Dx11¼H)

ITEM 1855-4-55 | w/ Solid S/S Lids

ITEM 1855-4-55HL | w/ Hinged S/S Lids

32 OZ. JARS (16Wx12Dx11¼H)

ITEM 1855-5-55 | w/ Solid S/S Lids

ITEM 1855-5-55HL | w/ Hinged S/S Lids

## B. 6 TIER ROTATING MIXOLOGY DISPLAYS

Complete Set with Cold Pucks.

16 OZ. JARS (15Wx15Dx17¼H)

ITEM 1858-4-55 | w/ Solid S/S Lids

ITEM 1858-4-55HL | w/ Hinged S/S Lids

32 OZ. JARS (15Wx15Dx17¼H)

ITEM 1858-5-55HL | w/ Hinged S/S Lids

## C. LUXE JAR DISPLAYS

Complete Set with Cold Pucks.

Unit Dimensions: 16Wx6Dx4H.

ITEM 3492-4-15 | w/ Solid S/S Lids

ITEM 3492-4-15HL | w/ Hinged S/S Lids

## D. STAINLESS STEEL MIXOLOGY DISPLAYS

Complete Set with Cold Pucks.

16 OZ. JARS (13½Wx5Dx4¾H)

ITEM 1850-4-55 | w/ Solid S/S Lids

ITEM 1850-4-55HL | w/ Hinged S/S Lids

32 OZ. JARS (16¾Wx6Dx5¾H)

ITEM 1850-5-55 | w/ Solid S/S Lids

ITEM 1850-5-55HL | w/ Hinged S/S Lids

## E. BAMBOO JAR DISPLAYS

Complete Set with Cold Pucks.

Unit Dimensions: 16Wx6Dx4H.

ITEM 1850-4-60 | w/ Solid S/S Lids

ITEM 1850-4-60HL | w/ Hinged S/S Lids

## F. MIXOLOGY JARS AND COMPONENTS

Jar Sets Include Base and Lid.

Cold Pucks Sold Separately.

The Base of the Jar is Double Walled  
for Insulation. The Lid is Lined with  
Silicone to Ensure a Good Seal.

### JAR SETS

ITEM 1851-4 | 16 oz. Jar w/ Solid S/S Lids

ITEM 1851-4HL | 16 oz. Jar w/ Hinged S/S Lids

ITEM 1851-5 | 32 oz. Jar w/ Solid Lids

### OTHER COMPONENTS

ITEM 1851-4JAR | Replacement Jar for 1851-4

ITEM 1851-5JAR | Replacement Jar for 1851-5

ITEM 1851-4PUCK | Cooling Puck for 16 oz. Jars

ITEM 1851-5PUCK | Cooling Puck for 32 oz. Jars

ITEM 1851-4LID | Solid S/S Lid for 16 oz. Jar

ITEM 1851-5LID | Solid S/S Lid for 32 oz. Jar

ITEM 1852-4 | S/S Hinged Lid for 16 oz. Jar

ITEM 1852-5 | S/S Hinged Lid for 32 oz. Jar

Please visit [www.calmil.com/legal](http://www.calmil.com/legal) for a complete list of California Proposition 65 related items.

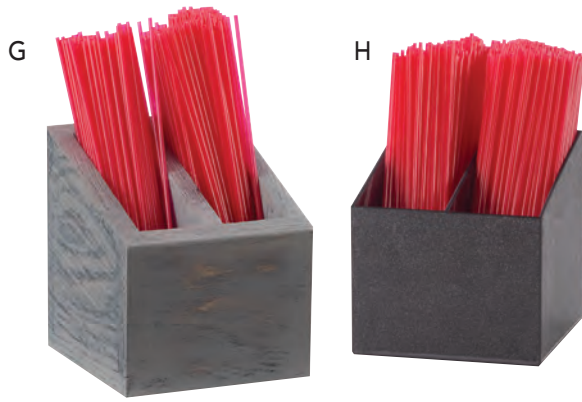

**G. ASHWOOD STIR STICK HOLDER**

3308-83 | 5Wx5Dx5½H

**H. CLASSIC STIR STICK HOLDER**

3308-13 | 5Wx5Dx5½H



**I. SIERRA 3 JAR TIERED DISPLAY NEW**

Includes 3 Jars.

4304-84 | 5Wx12¾Dx8H

**COLD CONCEPT SET FOR JARS**

Sold Separately.

22112 | 3¾Wx3¾Dx1H



**J. 3 JAR STRAW AND STIR STICK HOLDER**

Includes 3 Jars and Cut Out Lids.

ITEM 3334-13 | 12¾Wx5Dx5½H

ITEM C3334JAR | Replacement Jar



**K. RUSTIC JAR CONDIMENT DISPLAY**

Includes 3 Jars.

ITEM 3335-13 | 12¾Wx5Dx4H | 17 oz. Jars

ITEM 3336-13 | 12¾Wx5Dx6¼H | 32 oz. Jars

**REPLACEMENT JARS**

ITEM C3335JAR | 17 oz. Jars

ITEM C3336JAR | 32 oz. Jars

**L. SOUND-REDUCTION BLENDER HOUSING**

ITEM 498 | 12Wx12Dx24½H



Please visit [www.calmil.com/legal](http://www.calmil.com/legal) for a complete list of California Proposition 65 related items.



# bar & mixology displays

A



B



C



D



E



## A. MADERA TASTER CADDY

2.25" Cut Outs for Glasses.

Glasses Not Included.

ITEM 3480-99 | 13Wx4Dx2½H

ITEM 3062-15 | White Chalkboard Pen

## B. MELAMINE WOOD

### TASTING BOARD

2.25" Cut Outs for Glasses.

Glasses Not Included.

ITEM 3570-47M | 12Wx6Dx¼H

ITEM 3062-15 | White Chalkboard Pen

## C. FAUX SLATE & CEMENT

### TASTER FLIGHTS

2.25" Cut Outs for Glasses.

Glasses Not Included.

Specify Color: Faux Slate (65M),  
Faux Cement (77).

ITEM 3500-65M | 11¾Wx5Dx¾H

ITEM 3500-77 | 11¾Wx5Dx¾H

ITEM 3061-13 | Black Wet Erase Pen

ITEM 3062-15 | White Chalkboard Pen

## D. MADERA WRITE-ON

### TASTING CRATES

2.25" Cut Outs for Glasses.

Glasses Not Included.

ITEM 3058 | 10¼Wx3¼Dx2¾H

ITEM 3062-15 | White Chalkboard Pen

## E. WRITE-ON TASTING BOARDS

2.25" Cut Outs for Glasses.

Glasses Not Included.

ITEM 2063 | 12Wx6Dx½H | Madera

ITEM 2064 | 12Wx6Dx½H | Crushed Bamboo

ITEM 3062-15 | White Chalkboard Pen

## F. TRIO TASTER CADDY

2.25" Rings for Glasses.

Glasses Not Included.

ITEM 3366-13 | 5¼DIAx11¾H



Please visit [www.calmil.com/legal](http://www.calmil.com/legal) for a complete list of California Proposition 65 related items.



**G. ASHWOOD TASTER CADDY**  
 2.25" Cut Outs for Glasses. Glasses Not Included.  
 ITEM 3824 | 13Wx4Dx2¾H  
 ITEM 3062-15 | White Chalkboard Pen



**H. MELAMINE WOOD TASTING PADDLE**  
 2.25" Cut Outs for Glasses. Glasses Not Included.  
 Hickory Melamine (47M).  
 ITEM 3625-47M | 18Wx4Dx¼H



**I. INDUSTRIAL TASTER CADDY**  
 2.25" Cut Outs for Glasses. Glasses Not Included.  
 ITEM 22011-99 | 13½Wx4Dx3H  
 ITEM 3062-15 | White Chalkboard Pen

**J. INDUSTRIAL WINE TASTER**  
 1.5" Cut Outs for Glasses. Glasses Not Included.  
 ITEM 22010-99 | 13½Wx4Dx3H  
 ITEM 3062-15 | White Chalkboard Pen



Please visit [www.calmil.com/legal](http://www.calmil.com/legal) for a complete list of California Proposition 65 related items.



# bar & mixology displays



**A. POLYCARBONATE ICE BUCKET** **NEW**

ITEM 22056 | 12¼DIAx8¼H



**B. CLEAR ICE BUCKET**

ITEM 694 | 8Wx8½Dx8H

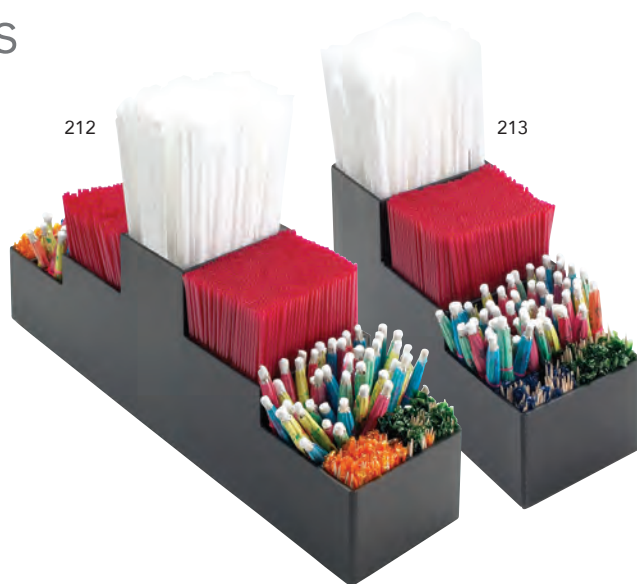

**C. CLASSIC BAR ORGANIZER**

ITEM 212 | 3¾Wx15½Dx5¼H

ITEM 213 | 3½Wx9¼Dx5¼H



3499-60

**D. BAR ORGANIZERS**

Specify Color: Bamboo (60), Madera (99).

ITEM 3499 | 10¼Wx7Dx4¼H



**E. BAMBOO STRAW HOLDER**

ITEM 3308-60 | 5Wx5Dx5½H



**F. BAMBOO BAR NAPKIN HOLDER**

ITEM 3309-60 | 5Wx5D | Napkin Size



**G. MADERA STIR-STICK HOLDER**

ITEM 3308-99 | 5¼Wx5¼Dx5½H



**H. STAINLESS MIXOLOGY ORGANIZER**

ITEM 1853-55 | 7¼Wx10Dx5¼H



**I. IRON NAPKIN HOLDER**

ITEM 1243 | 5Wx5H

Please visit [www.calmil.com/legal](http://www.calmil.com/legal) for a complete list of California Proposition 65 related items.



**J. CLASSIC BOTTLE DISPLAY**  
Specify Color: Crystal Ice (67) or Graphite (69).  
ITEM 1491 | 12Wx13Dx6¾H



**K. FROST LIT STEP BOTTLE DISPLAY**  
Includes LED Light with Multiple Colors and Sequences to Synchronize with Music. Ships by Truck Only.  
ITEM LQ31 | 30Wx18Dx18H



**L. UNDER LIT BOTTLE DISPLAY**  
Includes LED Light with Multiple Colors and Sequences to Synchronize with Music.  
ITEM 1269 | 24Wx14½Dx15½H





As we know, world hunger is a huge and ever-growing problem. In our search to give back, we came across an organization called Outside the Bowl (OTB). OTB is dedicated to making a positive impact in the world by helping feed the hungry. In an effort to feed as many people as possible, OTB invests in infrastructure uniquely called Super Kitchens. Super Kitchens are innovative, self-sustaining, and cut costs for organizations that feed those in need in their communities. As a result, more people are receiving the nourishment they so desperately need.

Outside the Bowl's Super Kitchens have the capacity of producing 6,000 meals a day! At only 2,000 meals a day, a kitchen is financially viable.

These meals are delivered to ministries and feeding partners throughout urban areas in Haiti, Mexico, South Africa, and Malawi – allowing feeding partners to effectively, efficiently, and sustainably feed the most vulnerable in their communities.

Cal-Mil has partnered with Outside the Bowl and is committed to their vision of a world in which all children are nourished, both physically and spiritually. Please join us in helping to build the next Super Kitchen!

You can donate at OTB's website: [www.outsidethebowl.org](http://www.outsidethebowl.org)

**Recent Accomplishments Include:**

- 9 Super Kitchens (Tijuana, Mexicali, Jalisco, Port-au-Prince, Port-de-Paix, George, Lilongwe, Paarl, Wellington)
- This past year we started taking steps to open Super Kitchens in Juarez and Guatemala City.
- 21.5 million meals served since 2009

We appreciate your consideration in partnering with us to feed the hungry ... body & soul. Even the smallest amount can make a huge difference.

Johnny Callahan  
President & CEO  
Cal-Mil

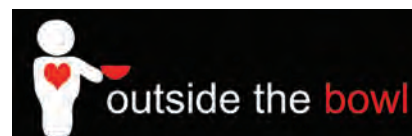





Homelessness is a growing concern not only in California, but in the Nation as a whole. According to the 2015 Homelessness Assessment, California has the highest number of unsheltered homeless people. Meanwhile, San Diego has escalated to 4th in the Nation in total homeless population.

Solutions for Change is a nonprofit organization that creates an innovative and permanent solution to family homelessness. Solutions for Change differs from the traditional containment model that offers short-term shelter, food handouts, and other “Band-Aids” that perpetuate, rather than solve the problem. Instead of these temporary solutions, they focus on empowering homeless families to change their lives permanently!

To accomplish this task, families participate in a 1,000 day program that equips moms and dads with skills, knowledge, and resources (including housing), as they continue to gain and maintain physical, mental, and financial health. By the time residents reach 500 days, they have full time jobs providing for their families.

Of those who graduate, there is a 93% success rate! They have helped to solve homelessness in San Diego County for 1,000 families and 2,500 children. Solutions for Change is solely funded by the generosity of donors, foundations, and corporations. In the past, Solutions for Change received some state and federal support for operations. However, when it was required of them to abandon their sobriety and work requirements, the organization returned more than half a million dollars in federal and state grants.

We invite you to join with the Cal-Mil family in partnering with Solutions for Change helping to transform lives of entire families!

To learn how you can volunteer, donate, and make a difference, visit [www.solutionsforchange.org](http://www.solutionsforchange.org)



Johnny Callahan  
President & CEO  
Cal-Mil





# replacement parts

## Replacement Parts for Beverage Dispensers

ITEM	BASE	ICE CHAMBER	BEV CHMBR	LID	INFUSION	SPIGOT	DRIP
972-1	C972-3B*	C972-1ICE	C972-1BEV	C972-3LID	C972-1INF	148-1580-49	308-4-13
972-2	C972-2B	C972-2ICE	C972-2BEV	C972-2LID	C972-2INF	148-1580-49	308-4-13
972-3	C972-3B*	C972-3ICE	C972-3BEV	C972-3LID	C972-3INF	148-1580-49	308-4-13
972-5	C972-5B*	C972-5ICE	C972-5BEV	C972-5LID	C972-5INF	148-1580-49	308-4-13
971-5	C972-5B*	C971-5ICE	C971-5BEV	C972-5LID	N/A	148-1580-49	308-4-13
1111	C1111BASE	C972-2ICE	C1111-BEV	C1111LID	C972-2INF	148-1111	308-4-13
1111a	C1111BASE	C972-2ICE	C1111A	C1111LID	N/A	148-1580-49	308-4-13
1111-55	C111155BASE	C972-2ICE	C1111-BEV	BR103LID	C972-2INF	148-1111	308-4-13
932-2	N/A	C972-2ICE	C932-2BEV	C932-2LID	C972-2INF	148-1580-49	308-4-13
932-3	C932-3BASE	C972-3ICE	C932-3BEV	C932-3LID	C972-3INF	148-1580-49	308-4-13
1112-1	N/A	C1112-1ICE	N/A	C938LID	C1112-1INF	148-1580-49	681-4-13
1112-3	N/A	C1112-3ICE	N/A	C938LID	C1112-3INF	148-1580-49	681-4-13
1112-1A	N/A	C1112-1ICE	N/A	C1112-LID	C1112-1INF	148-1580-49	681-4-13
1112-3A	N/A	C1112-3ICE	N/A	C1112-LID	C1112-3INF	148-1580-49	681-4-13
1112-5A	N/A	C1112-5ICE	N/A	C1112-5LID	C1112-5INF	148-1580-49	681-4-13
1112-1-13	C1112GBASE	C1112-1ICE	N/A	C938LID	C1112-1INF	148-1580-49	681-4-13
1112-3-13	C1112GBASE	C1112-3ICE	N/A	C938LID	C1112-3INF	148-1580-49	681-4-13
1112-1A-13	C1112GBASE	C1112-1ICE	C1112-1ABEV	C1112-LID	C1112-1INF	148-1580-49	681-4-13
1112-3A-13	C1112GBASE	C1112-3ICE	C1112-3ABEV	C1112-LID	C1112-3INF	148-1580-49	681-4-13
1132-1	C11321†	C1112-1ICE	C1527-1BEV §	C1527LID	C1112-1INF	148-1580-49	681-4-13
1132-3	C11321†	C1112-3ICE	C1527-3BEV §	C1527LID	C1112-3INF	148-1580-49	681-4-13
1132-5	C11325†	C1527-5ICE	C1527-5BEV	C1527-5LID	C1527-5INFICE	148-1580-49	681-4-13
1282-3A	N/A	C2016ICE	N/A	N/A	C2016ICEINF	148-1580-49	N/A
1494	N/A	N/A	N/A	N/A	N/A	148-1580-49	N/A
1610	C1610BASE	C1610ICE	C1610BEV	C1610LID	C1610INF	148-1580-49	308-4-13
1010	N/A	C1010ICE	C1010BEV	N/A	C1010INF	148-1010	N/A
152-SS	N/A	C972-3ICE	C972-3BEV	C1525SLID	C972-3INF	148-1580-49	308-4-13
1527-1	C1527-BASE**	C1112-1ICE	C1527-1BEV	C1527LID	C1112-1INF	148-1580-49	681-4-13
1527-3	C1527-BASE**	C1112-3ICE	C1527-3BEV	C1527LID	C1112-3INF	148-1580-49	681-4-13
1580-2	C1580-BASE†	C1112-1ICE	C1580-2BEV §	C1580-LID	C1112-1INF	148-1580-49	308-4-13
1580-3	C1580-BASE†	C971-5ICE	C1580-3BEV §	C1580-LID	C971-5INF	148-1580-49	308-4-13
1602-1	C1602-BASE††	C1112-1ICE	C1527-1BEV §	C1527LID	C1112-1INF	148-1580-49	681-4-13
1602-3	C1602-BASE††	C1112-3ICE	C1527-3BEV §	C1527LID	C1112-3INF	148-1580-49	681-4-13
1733-2	N/A	N/A	N/A	C938LID	N/A	148-1580-49	N/A
1733-3	N/A	N/A	N/A	C938LID	N/A	148-1580-49	N/A
1745	N/A	N/A	N/A	C1111LID	N/A	148-1111	N/A
1990-3	N/A	N/A	C1990-3BEV	N/A	C1112-3INF	148-1580-49	308-4-49
1991-3	N/A	N/A	C1991-3BEV	N/A	C1112-3INF	148-1580-49	681-4-13
2016	N/A	C2016ICE	C20163BEV	C2016LID	C2016ICEINF	148-1580-49	681-4-13
C3002-LID	N/A	C1112-3ICE	C1991-3BEV	C3002-LID	C1112-3INF	148-1580-49	681-4-13
3324-3	C3324BASE	C2016ICE	C2016-3BEV	C2016LID	C2016ICEINF	148-1580-49	308-4-49
JC201	CJC200BASE	C971-5ICE	CJC310	N/A	C971-5INF	148-1580-49	N/A
JC301	C30113	C971-5ICE	CJC310	CJUICE LID	C971-5INF	148-1580-49	308-4-13

\*Specify Base Color: Black (17), Dark Wood (52), Light Wood (53).

\*\* Specify Base Color: Dark Wood (52), Bamboo (60), Midnight Bamboo (96).

† Specify Base Color: Black (13), Silver (74).

†† Specify Base Color: Black (13), Stainless Steel (55).

§ Specify spigot color: Black or Chrome.

## Replacement Shelves, Drawers, & Bins

ITEM	Description	PART#	ITEM	Description	PART#
1203	Top Tray	1203-TOP	1720-3	Clear	1204DRAWER
	Bottom Tray	1203-BOTTOM	1720-4	Clear	1204DRAWER
204	Clear	1204DRAWER	1718-60	Clear	C1718DRAWER
1204-13	Black	1204DRAWER-13	813-52	Dark Wood	813-52DRAWER
1204-52	Black	1204DRAWER-13	3054	Cold Concept Items	Cold Pack

Please visit [www.calmil.com/legal](http://www.calmil.com/legal) for a complete list of California Proposition 65 related items.

CORPORATE OFFICES  
CAL•MIL  
4079 Calle Platino  
Oceanside, CA 92056-5805



Phone: (760) 630-5100  
Toll Free: (800) 321-9069  
General Fax: (760) 630-9865  
For Ordering Fax: (760) 630-5010  
US, Alaska, Hawaii & Canada

## TERMS OF SALE

All Enclosed Prices and Terms  
EFFECTIVE January 1, 2020

### 1. FREIGHT TERMS

All weights and measurements shown herein are approximate.  
All orders are FOB Oceanside, CA.

#### A. FREIGHT PREPAID - CONTINENTAL USA

Freight will be prepaid on orders \$7,000 NET or more, based on a single order for a single delivery within the continental U.S. All Cal•Mil catalog products may be combined to obtain prepaid freight, excluding Custom Orders or Net Quoted pricing of catalog items. Cal-Mil is not responsible for any accessorial charges or extended service charges.

#### B. FREIGHT - INTERNATIONAL

All international freight is the sole responsibility of the Broker, Dealer or any purchasing entity.

#### C. FREIGHT COLLECT or PREPAID AND CHARGED BACK:

All orders, not meeting Cal•Mil Prepaid Freight Policy and all Custom Manufactured Products are FOB Oceanside, CA, Freight Collect or Prepaid and Charged Back.

#### D. 3<sup>rd</sup> PARTY OR COLLECT FREIGHT

All 3<sup>rd</sup> party or collect shipments are solely the responsibility of the Customer. All 3<sup>rd</sup> party or collect damage claims, lost items, freight disputes or any other type of charges are the sole responsibility of the Customer. Any payments sent to CAL-MIL for claims will be forwarded to the customer in the form of a credit memo.

### 2. PRICES

All published prices are LIST in U.S. Dollars and are subject to change without notice. All orders will be received with the understanding that prices will be those in effect at the time of shipment. These prices are exclusive of all export fees, transportation charges, sales taxes or any special taxes which may be levied by Federal, State or City Governments.

### 3. RETURNS

The request to return goods must be made within 60 days of the Invoice Date. No merchandise may be returned without a written authorization number from the factory. Contact Cal•Mil Customer Service at 1-800-321-9069 to request authorization. Merchandise must be shipped Freight Prepaid by sender. All return goods must be in unused condition and packaged in their original shipping cartons and packing material. Credit issued will be based only on

product returned in restockable condition. The determination of the condition of the goods will be made solely by Cal•Mil. Custom, Discontinued or Non-standard merchandise may not be returned. ALL RETURNS ARE SUBJECT TO A 20% RESTOCKING CHARGE.

### 4. TERMS

Net 30 Days O.A.C. All orders are subject to acceptance by Cal•Mil, in accordance with our "Terms of Sale", regardless of any form in which a purchase order is submitted. All Credit Card payments can be subject to 3% fee.

### 5. MINIMUM ORDER

Minimum Order for established accounts will be \$250.00 LIST. A \$20.00 Handling Charge will be applied to all orders under \$250.00 LIST. Orders calling for Less Than Standard Pack will be charged \$5.00 NET per Broken Case.

### 6. CUSTOM PRODUCTS

All CUSTOM Products are FOB OCEANSIDE, CA. Finished Custom Quantities may vary by + or - 5%.

### 7. TITLES & DAMAGES

Merchandise will be delivered FOB Factory and title passes to buyer upon delivery of merchandise to a common carrier for shipment to buyer. Should damage occur, it is the Consignee's responsibility to notify the delivering carrier within 48 hours. Retain all cartons, packing material and merchandise for carrier inspection. Call Cal•Mil Customer Service at 1-800-321-9069 within 48 hours to notify of damage. We are willing to assist in filing claims, but the filing is Consignee's responsibility.

### 8. SHORTAGES/ERRORS

#### A. SHORTAGE OF MERCHANDISE

Contact Cal•Mil Customer Service at 1-800-321-9069 to report any shortage of merchandise within 48 hours of receipt.

#### B. ERRORS

Cal•Mil is not responsible for typographical errors made in the act of quoting, acknowledgements, publications or invoices. All such errors are subject to correction.

### 9. GENERAL

This Agreement shall be governed by the laws of the state of California.

### CALIFORNIA PROP 65 WARNING:

Some of the products described in this catalog may contain a chemical known to the State of California to cause cancer, birth defects or other reproductive harm. Please visit [www.calmil.com/legal](http://www.calmil.com/legal) for a complete list of California Proposition 65 related items.



# EMPIRE collection



**CAL•MIL**  
4079 Calle Platino  
Oceanside, CA 92056

(760) 630-5100 Phone  
(760) 630-5010 Fax For Ordering  
(760) 630-9865 General Fax

(800) 321-9069 Toll Free  
(U.S.A. & Canada)

[www.calmil.com](http://www.calmil.com)  
[contactcalmil@calmil.com](mailto:contactcalmil@calmil.com)

© 2020 CAL•MIL Plastic Products, Inc.